



# K100 Programmable Display Beacon Product Manual

Original Instructions

p/n: 245810 Rev. A

11-Aug-25

© Banner Engineering Corp. All rights reserved. [www.bannerengineering.com](http://www.bannerengineering.com)

# Contents

<b>Chapter 1 Features.....</b>	<b>3</b>
Models.....	3
<b>Chapter 2 Wiring.....</b>	<b>4</b>
<b>Chapter 3 Pro Editor Configuration for the K100 Programmable Display Beacon.....</b>	<b>5</b>
Discrete Control.....	5
Basic I/O State.....	6
Advanced I/O State.....	6
I/O Block I/O State.....	7
Sequence Mode.....	7
Timer Mode.....	7
Counter Mode.....	8
Measure Mode.....	9
Pulse Control.....	10
Demo Mode.....	10
Factory Reset.....	10
Display Settings.....	10
<b>Chapter 4 Specifications.....</b>	<b>12</b>
FCC Part 15 Class B for Unintentional Radiators.....	13
Industry Canada ICES-003(B).....	13
Dimensions.....	14
<b>Chapter 5 Accessories.....</b>	<b>15</b>
Cordsets.....	15
Brackets.....	15
Elevated Mount System.....	16
Pro Editor Hardware.....	16
<b>Chapter 6 Product Support and Maintenance.....</b>	<b>17</b>
UTF-8 Encoding Table and Unicode Characters.....	17
Clean with Mild Detergent and Warm Water.....	21
Repairs.....	21
Contact Us.....	22
Banner Engineering Corp Limited Warranty.....	22

Chapter Contents

Models.....3

# Chapter 1 Features

The K100 Programmable Display Beacon provides diagnostics and indication for control engineers and OEMs who need to improve the interaction between operators and equipment to drive response speed and productivity improvements.



- Easily configurable, versatile display can be installed nearly anywhere, making it a simple yet powerful alternative to complex HMIs and other displays
- Great for displaying takt time, equipment status, assembly sequences, counts, and measurements where they are most useful
- Discrete models integrate into many different systems and applications, especially Banner sensing, safety, and monitoring solutions
- Quick and easy configuration—simply define the desired text and call it via discrete control or process data
- Bright white LED display and multicolored beacon LEDs legible from 10 meters away inform operators about exactly what is going on so they can respond quickly and accurately
- IP66- and IP69K per ISO 20653-rated polycarbonate housing resists impact and condensation to provide clear communication in challenging and changing environmental conditions

## Models

Model Key

Series	Style	Type	Voltage	Color	Control	Audible	Connector <sup>(1)</sup>
K100P	D	BL		RGB	D15		Q
K100P = K100 Pro	D = Display	BL = Beacon Light	Blank = DC	RGB = Multicolor	D15 = Discrete 15 states	Blank = No Audible A = Audible	Q = Integral 5-pin M12 male quick-disconnect connector

<sup>(1)</sup> Models with a quick-disconnect connector require a mating cordset.

Chapter Contents

# Chapter 2 Wiring

Wiring

5-Pin Male M12 Pinout	Pinout Key and Wiring
	<ul style="list-style-type: none"><li>1. Brown - Input 2</li><li>2. White - Input 3</li><li>3. Blue - DC Common</li><li>4. Black - Input 1</li><li>5. Gray - Input 4</li></ul>

Chapter Contents

Discrete Control.....5  
 Sequence Mode.....7  
 Timer Mode.....7  
 Counter Mode.....8  
 Measure Mode.....9  
 Pulse Control.....10  
 Demo Mode.....10  
 Factory Reset.....10  
 Display Settings.....10

# Chapter 3 Pro Editor Configuration for the K100 Programmable Display Beacon

Applications



Banner's Pro Editor software offers an easy way to configure Pro Series-enabled indication, touch, and illumination devices, allowing users full control of device states and device logic modes. The easy-to-use configuration software provides a variety of tools and capabilities to solve a wide range of applications such as indicating machine status or warm-up time, indicating unique steps in an assembly process, or incorporating status information into touch buttons.

Setup any Pro Series-enabled device using the free Pro Editor software, available for download at [www.bannerengineering.com/proeditor](http://www.bannerengineering.com/proeditor).

## Discrete Control

Selecting the Discrete Control tile displays three I/O State tiles:

- Basic
- Advanced
- I/O Block



**Basic I/O State**

Basic four-state control. Configurations made in Basic I/O State assign one wire to one state, with the following override control:

- Pin 1 (Brown) overrides Pin 4 (Black)
- Pin 2 (White) overrides Pins 1 and 4 (Brown and Black)
- Pin 5 (Gray) overrides Pins 1, 2, and 4 (Brown, White, and Black)

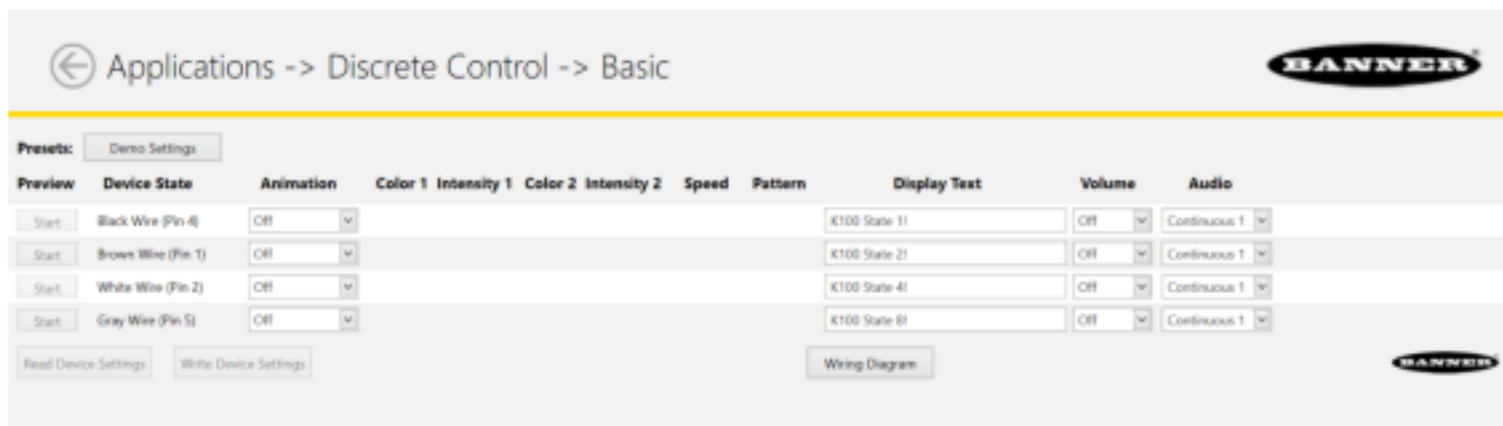

**Advanced I/O State**

Advanced, default I/O state, with fifteen state options for maximum configuration ability. Configurations made in Advanced I/O State assign binary wiring combinations of all valid inputs to each state. Both the indication LEDs and the display text can be programmed for each of the states.

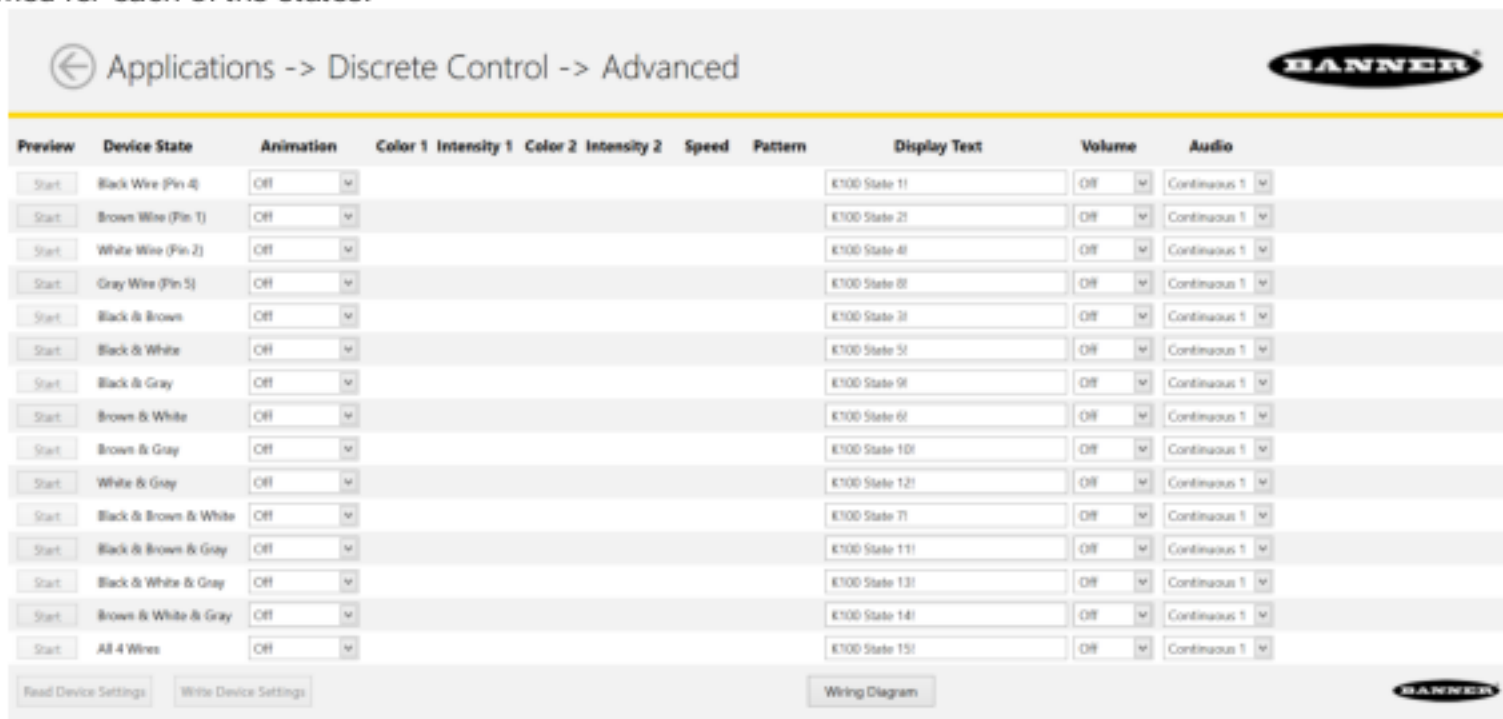

### I/O Block I/O State

Three-state control for use with I/O block. Configurations made in I/O Block assign state to the black, white, and combination of black and white wires for use with the I/O blocks, for which power (brown) and common (blue) are always on for five-pin connections.

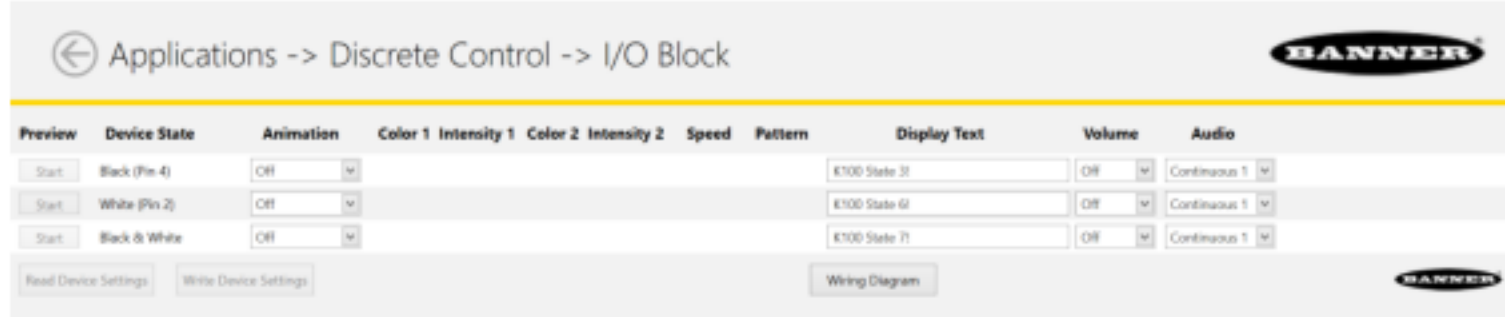

## Sequence Mode

Sequence Mode allows up to sixteen states that a single input can control. A pulse on the input wire moves the K100 Pro to the next state.

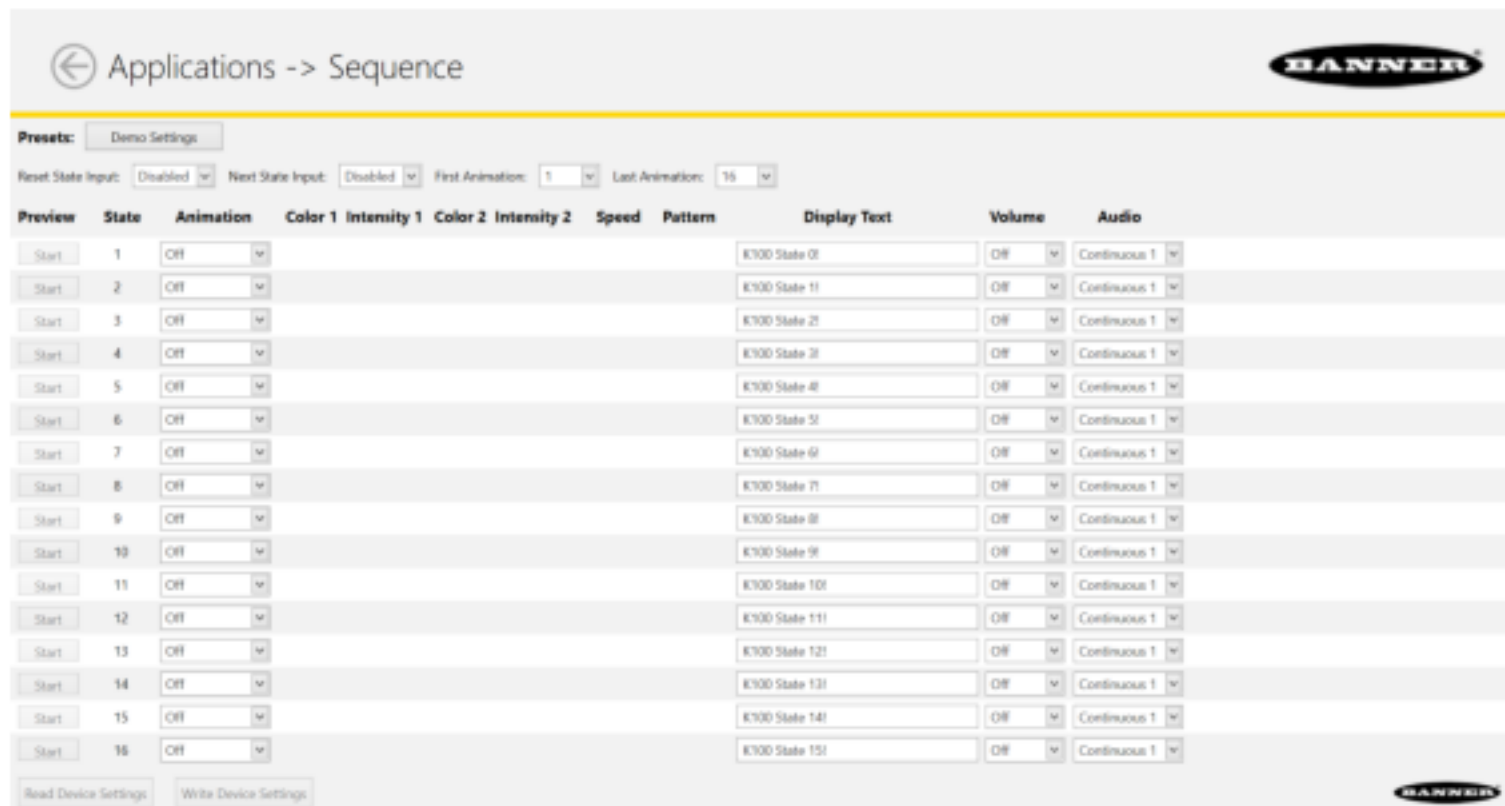

Reset State Input	Choose the desired input wire to restart the K100 Pro to the First Animation as chosen in the dropdown menu.
Next State Input	Choose the desired input wire to move K100 Pro to the next state in the series until the Last Animation is reached.
First Animation	Choose the initial state to display as the sequence is initiated.
Last Animation	Choose the final state to include in the sequence.

## Timer Mode

Set a total time and up to four thresholds. Start and stop the timer counting up or down with discrete control. Colors change across threshold values.

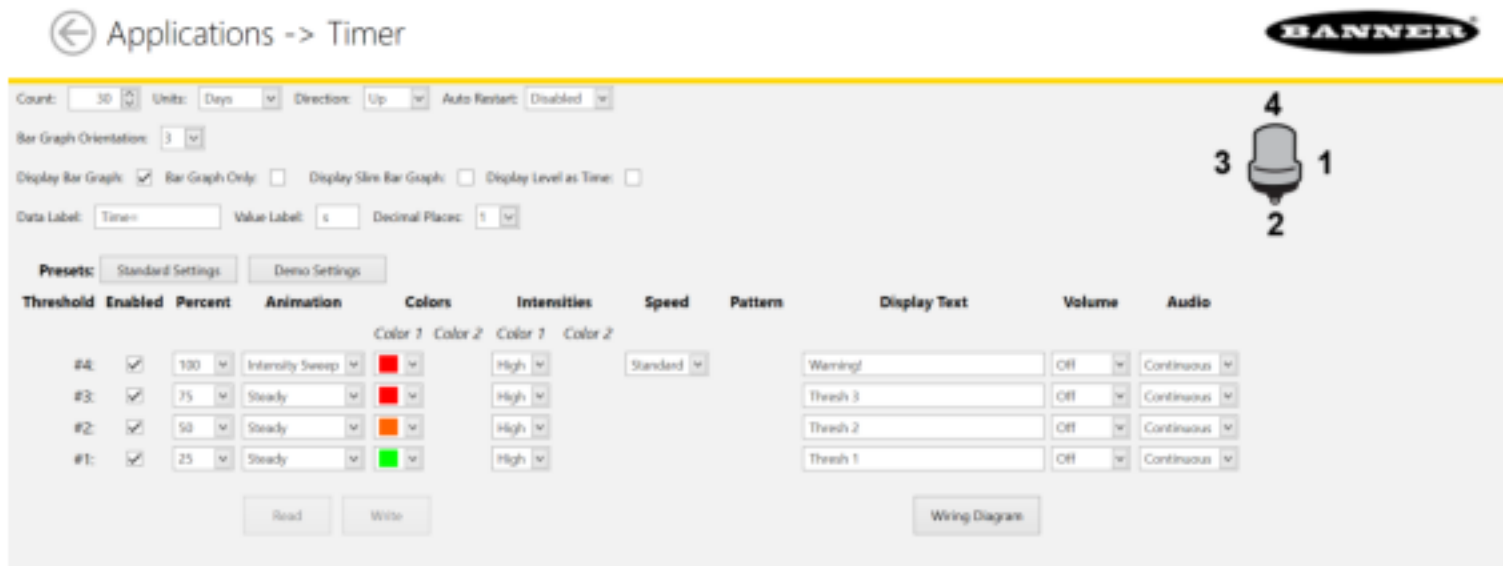

Count Seconds	The total time of the timer.
Direction	Up: Counts up from zero to Count Seconds. Down: Counts down from Count Seconds to zero.
Reset Input	Enable or disable the input wire to reset the timer to the initial value.
Auto Restart	The timer loops back to the original value automatically when it reaches its final value.

Bar Graph Orientation	Determine the starting side of the bar graph.
Decimal Places	Determine the number of decimal places displayed on the Count Value.
Display Graph Only	Only display the bar graph, and not the numerical Count Value.
Display Bar Graph	Display the bar graph across the full display.
Display Slim Bar Graph	Display the bar graph as a single line of LEDs.
Display Level as Time	Display the time in HH:MM:SS format without data labels.
Data Label	Text that displays before the Count Value.
Value Label	Text that displays after the Count Value to indicate the units displayed. This can be up to three characters.
Standard Settings	Reset the K100 Pro to predetermined settings.

## Counter Mode

Set a total count and up to four thresholds. Discrete, rising edge pulses count up or down. Colors change across threshold values.

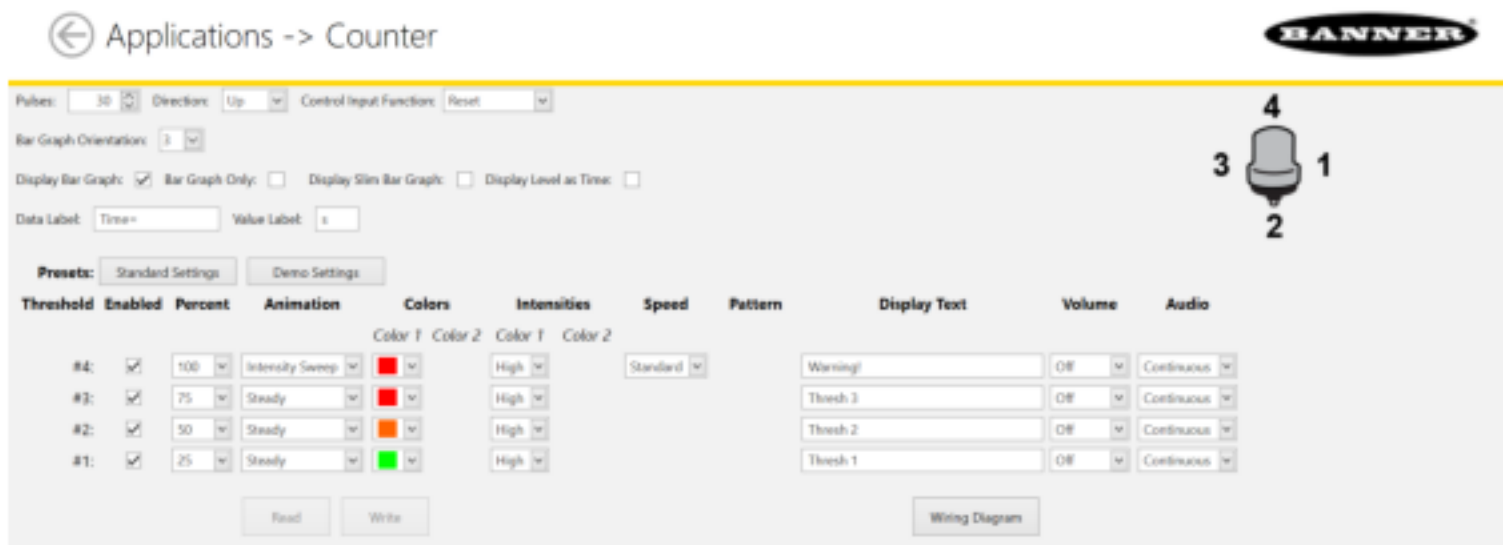

Pulses	Determine the number of counts that are either counted up to or counted down from, depending on the chosen direction.
--------	---

Continued on page 9

Continued from page 8

Direction	Up: Counts from zero to Pulses. Down: Counts from Pulses to zero.
Reset Input	Enable or disable the input wire to reset the count to the initial value.

Bar Graph Orientation	Determine the starting side of the bar graph.
Decimal Places	Determine the number of decimal places displayed on the Count Value.
Display Graph Only	Only display the bar graph, and not the numerical Count Value.
Display Bar Graph	Display the bar graph across the full display.
Display Slim Bar Graph	Display the bar graph as a single line of LEDs.
Data Label	Text that displays before the Count Value.
Value Label	Text that displays after the Count Value to indicate the units displayed. This can be up to three characters.
Standard Settings	Reset the K100 Pro to predetermined settings.

# Measure Mode

Measure Mode uses the K100 Pro to display a measurement as either PWM control or PFM control.

← Applications -> Measure

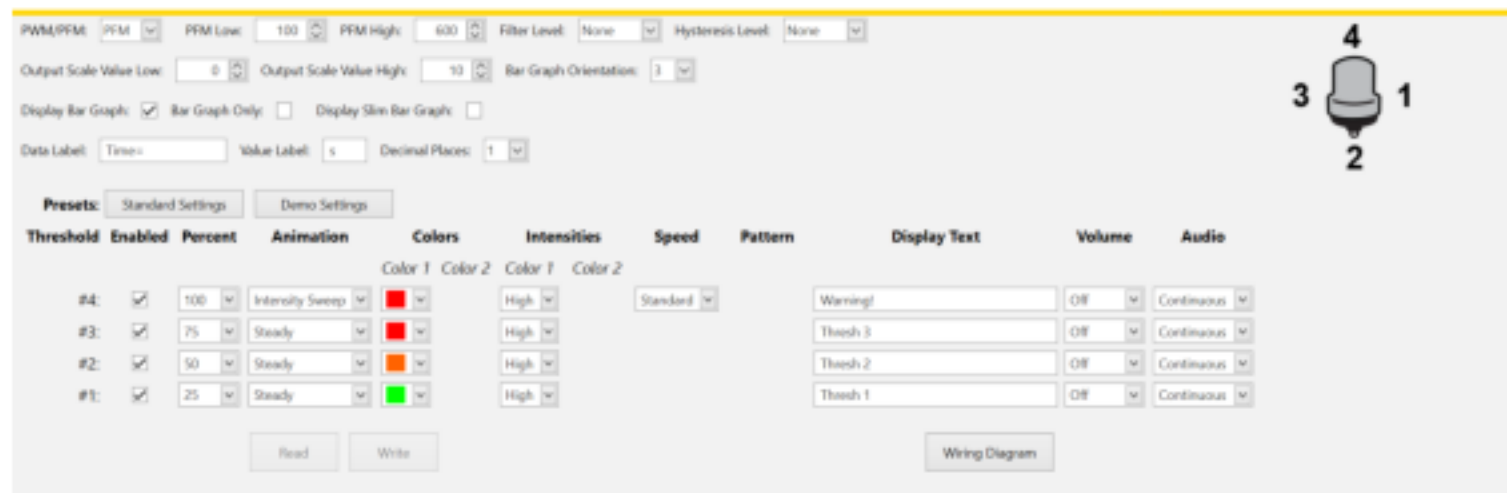

PWM/PFM	PWM: Pulse-Width Modulation. PFM: Pulse-Frequency Modulation.
PWM/PFM Low	The lowest frequency of the input range.
PWM/PFM High	The highest frequency of the input range.
Filter Level	The level of filtering used to minimize the effects of noise on the output.
Hysteresis Level	The level of lag between the measurement thresholds to minimize the flickering at switch points.
Output Scale Value Low	The low-end value of the output translated from the input frequency.
Output Scale Value High	The high-end value of the output translated from the input frequency.

Bar Graph Orientation	Determine the starting side of the bar graph.
Decimal Places	Determine the number of decimal places displayed on the Count Value.
Display Graph Only	Only display the bar graph, and not the numerical value.
Display Bar Graph	Display the bar graph across the full display.
Display Slim Bar Graph	Display the bar graph as a single line of LEDs.
Data Label	Text that displays before the Count Value.
Value Label	Text that displays after the Count Value to indicate the units displayed. This can be up to three characters.
Standard Settings	Reset the K100 Pro to predetermined settings.

# Pulse Control

Selecting the Pulse Control tile displays up to sixteen states that correspond to input frequencies on the white wire. The number of states (1) and input characteristics (2) are user-defined. Ranges are calculated (3).

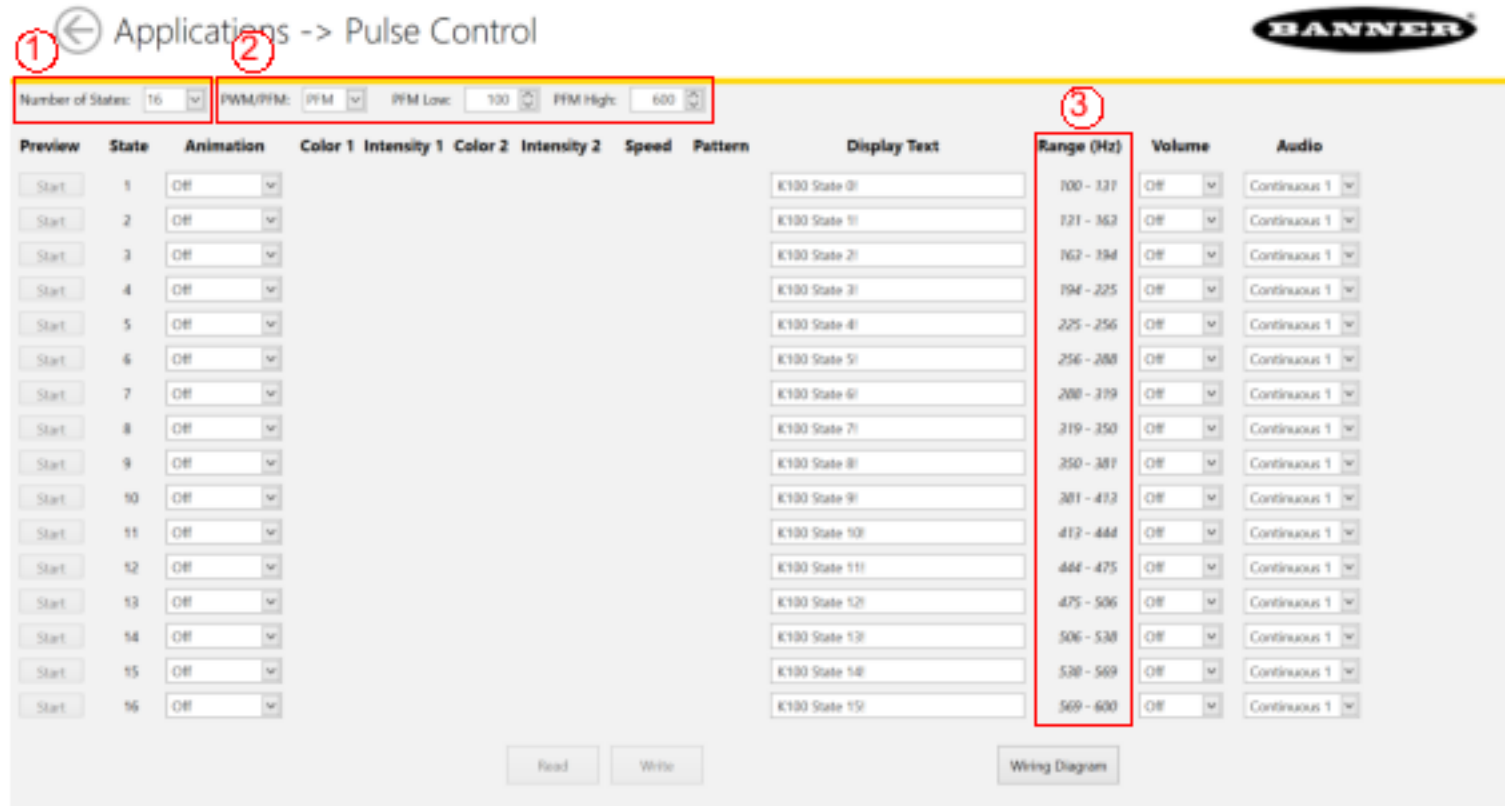

Number of States	Determine the number of states from 1 to 16.
PWM/PFM	Select either PWM (Pulse Width Modulation) or PFM (Pulse Frequency Modulation) as the device's input.
PWM/PFM Low	Determine the low end of the input signal range.
PWM/PFM High	Determine the high end of the input signal range.

## Demo Mode

Activate Demo Mode on the device to cycle through various modes automatically as a demonstration.

## Factory Reset

Restore the K100 Pro to default settings.

## Display Settings

Display Settings are a type of advanced settings that are accessible across all Applications.



Text Color	Configure the primary text color as either white or black.
Brightness	Control the brightness of the display text.
Scroll Direction	Scroll the display text either clockwise or counterclockwise when looking at the top of the device.
Scroll Speed	Control the speed the display text scrolls.
Scroll Mode	Auto: Scrolls if the number of characters is greater than fourteen. Off: Does not scroll the display text. On: Scrolls the display text regardless of the number of characters.
Connector Orientation	Determine the orientation of the connector when installed. The display text automatically adjusts to the correct orientation.
Text Justification	Control the alignment of the display text: left, right, or center.
Mirror	Enable this setting to reverse the display text so that it can be read in a mirror.
Repeat Display Value	Display the dynamic value of Timer, Counter, or Measure Mode multiple times around the device for increased visibility. The value repeats the maximum number of times allowed by the display size. As the size of the value increases, the device updates the number of times the value is displayed. The Data Label should be blank when this setting is enabled.
Deadspace	Enable this setting to add a blank space at the end of the display to separate scrolling text.

Chapter Contents

FCC Part 15 Class B for Unintentional Radiators ..... 13  
 Industry Canada ICES-003(B).....13  
 Dimensions.....14

# Chapter 4 Specifications

Supply Voltage

12 V DC to 30 V DC

Use only with a suitable Class 2 power supply (UL) or SELV power supply (CE)

Supply Current

550 mA max. at 12 V DC

270 mA max. at 24 V DC

220 mA max. at 30 V DC

Supply Protection Circuitry

Protected against reverse polarity and transient voltages

Leakage Current Immunity

400 µA

Indicator Response Time

On response: 325 ms (max)

Off response: 20 ms (max)

Connections

Integral 5-pin M12 male quick-disconnect connector

Models with a quick-disconnect connector require a mating cordset

Do not spray cable with high-pressure sprayer or cable damage will result

Operating Temperature

-40 °C to +50 °C (-40 °F to +122 °F)

Storage Temperature

-40 °C to +70 °C (-40 °F to +158 °F)

Environmental Rating

Rated IP66 and IP69K per ISO 20653

UL Type 4X

Vibration and Mechanical Shock

Meets IEC 60068-2-6 requirements (Vibration: 10 Hz to 55 Hz, 1.0 mm amplitude, 5 minutes sweep, 30 minutes dwell)

Meets IEC 60068-2-27 requirements (Shock: 15G 11 ms duration, half sine wave)

Impact: IK10 (60068-2-75)

Audible Characteristics

Sound Intensity at 2.5 KHz, at 1 m (typical):

Low volume setting: 93 dB

Medium volume setting: 96 dB

High volume setting: 101 dB

Character Limit

Discrete Control: 29 characters

All other modes: 32 characters

Construction

Black polycarbonate housing

Smoky polycarbonate dome

Certifications



Banner Engineering BV  
 Park Lane, Culliganlaan 2F bus 3  
 1831 Diegem, BELGIUM



Required Overcurrent Protection



**WARNING:** Electrical connections must be made by qualified personnel in accordance with local and national electrical codes and regulations.

Overcurrent protection is required to be provided by end product application per the supplied table.

Overcurrent protection may be provided with external fusing or via Current Limiting, Class 2 Power Supply.

Supply wiring leads < 24 AWG shall not be spliced.

For additional product support, go to [www.bannerengineering.com](http://www.bannerengineering.com).

Supply Wiring (AWG)	Required Overcurrent Protection (A)	Supply Wiring (AWG)	Required Overcurrent Protection (A)
20	5.0	26	1.0
22	3.0	28	0.8
24	2.0	30	0.5

Mounting

M36 x 2 threaded base, maximum torque 5 N·m (44 inch-lbf)

Interior 3/4-14 NPT thread

Mounting nut included

## Indicator Characteristics

Color	Dominant Wavelength (nm) or Color Temperature (CCT)	Color Coordinates <sup>(2)</sup>		Lumen Output (Typical at 25 °C)
		x	y	
Green	523	0.159	0.6987	30.4
Red	620	0.6895	0.3087	14.6
Orange	599	0.5992	0.3752	17.7
Amber	588	0.535	0.4223	19.8
Yellow	575	0.4518	0.4834	22.4
Lime Green	560	0.3655	0.5471	25
Spring Green	506	0.1572	0.5171	26.6
Cyan	491	0.1565	0.3201	21.3
Sky Blue	484	0.1443	0.2271	16.8
Blue	467	0.1371	0.0555	5.4
Violet	415	0.2141	0.0904	7.9
Magenta	-	0.3661	0.1644	11.4
Rose	-	0.4976	0.2201	12.9
White	5500K	0.3309	0.3385	41.7

## FCC Part 15 Class B for Unintentional Radiators

(Part 15.105(b)) This equipment has been tested and found to comply with the limits for a Class B digital device, pursuant to part 15 of the FCC Rules. These limits are designed to provide reasonable protection against harmful interference in a residential installation. This equipment generates, uses, and can radiate radio frequency energy and, if not installed and used in accordance with the instructions, may cause harmful interference to radio communications. However, there is no guarantee that interference will not occur in a particular installation. If this equipment does cause harmful interference to radio or television reception, which can be determined by turning the equipment off and on, the user is encouraged to try to correct the interference by one or more of the following measures:

- Reorient or relocate the receiving antenna.
- Increase the separation between the equipment and receiver.
- Connect the equipment into an outlet on a circuit different from that to which the receiver is connected.
- Consult the dealer or an experienced radio/TV technician for help.

(Part 15.21) Any changes or modifications not expressly approved by the party responsible for compliance could void the user's authority to operate this equipment.

## Industry Canada ICES-003(B)

This device complies with CAN ICES-3 (B)/NMB-3(B). Operation is subject to the following two conditions: 1) This device may not cause harmful interference; and 2) This device must accept any interference received, including interference that may cause undesired operation.

Cet appareil est conforme à la norme NMB-3(B). Le fonctionnement est soumis aux deux conditions suivantes : (1) ce dispositif ne peut pas occasionner d'interférences, et (2) il doit tolérer toute interférence, y compris celles susceptibles de provoquer un fonctionnement non souhaité du dispositif.

<sup>(2)</sup> Refer to CIE 1931 chromaticity diagram or color chart, to show equivalent color with indicated color coordinates. Actual coordinates may differ by 10%.

# Dimensions

All measurements are listed in millimeters [inches], unless noted otherwise. The measurements provided are subject to change.

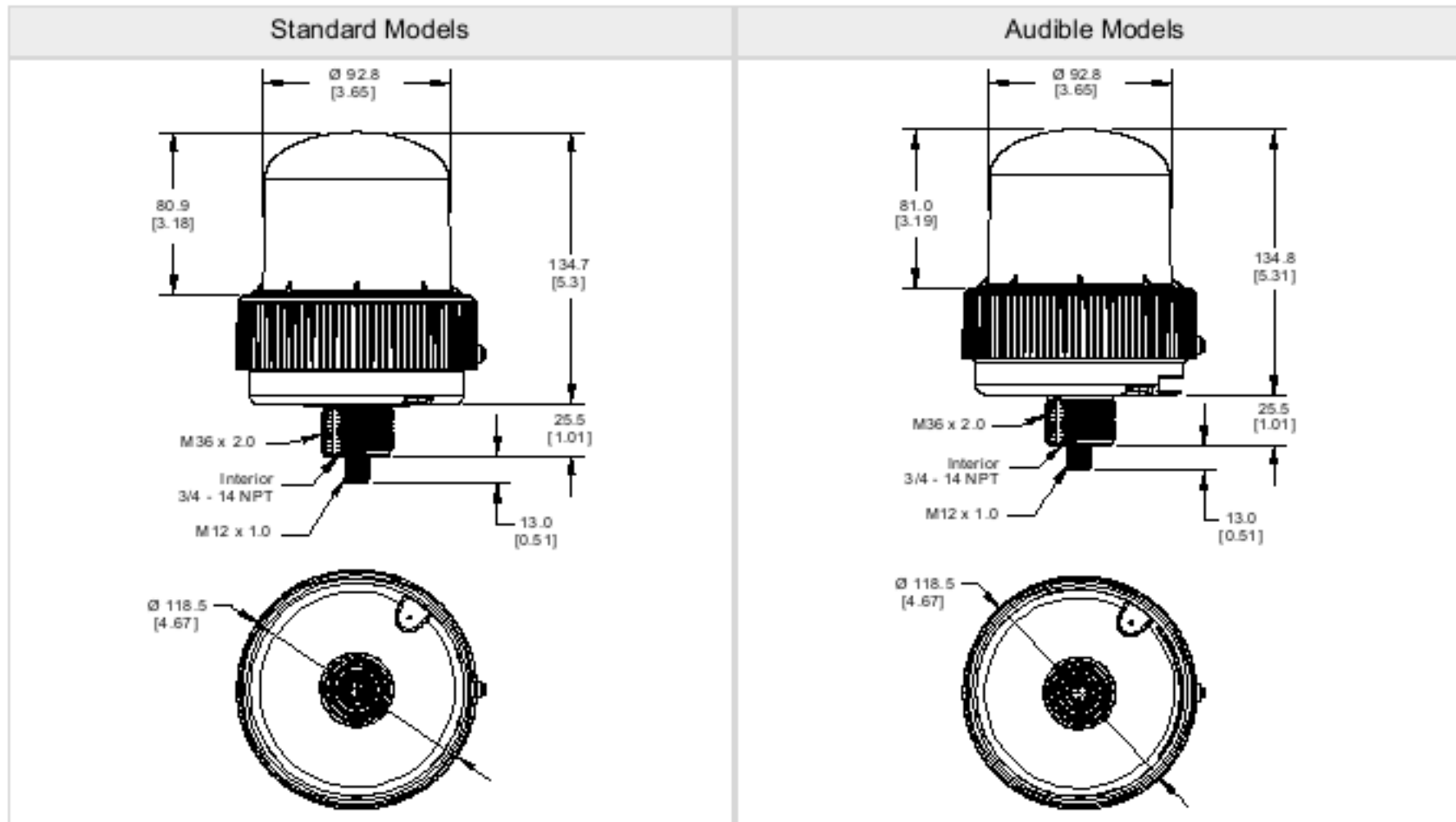

Chapter Contents

Cordsets.....15  
 Brackets.....15  
 Elevated Mount System.....16  
 Pro Editor Hardware.....16

# Chapter 5 Accessories

## Cordsets

All measurements are listed in millimeters [inches], unless noted otherwise. The measurements provided are subject to change.

5-pin A-Code Double-Ended M12 Female to M12 Male Cordsets				
Model	Length	Dimensions (mm)	Pinouts	
BC-M12F5-M12M5-22-1	1 m (3.28 ft)		Female	1 = Brown 2 = White 3 = Blue 4 = Black 5 = Gray
BC-M12F5-M12M5-22-2	2 m (6.56 ft)			
BC-M12F5-M12M5-22-5	5 m (16.4 ft)			
BC-M12F5-M12M5-22-8	8 m (26.25 ft)			
BC-M12F5-M12M5-22-10	10 m (30.81 ft)			
BC-M12F5-M12M5-22-15	15 m (49.2 ft)		Male	

5-pin A-Code Double-Ended M12 Female Right-Angle to M12 Male Right-Angle Cordsets				
Model	Length	Dimensions (mm)	Pinouts	
BC-M12F5A-M12M5A-22-1	1 m (3.28 ft)		Female	1 = Brown 2 = White 3 = Blue 4 = Black 5 = Gray
BC-M12F5A-M12M5A-22-2	2 m (6.56 ft)			
BC-M12F5A-M12M5A-22-5	5 m (16.4 ft)			
BC-M12F5A-M12M5A-22-8	8 m (26.25 ft)			
BC-M12F5A-M12M5A-22-10	10 m (30.81 ft)			
BC-M12F5A-M12M5A-22-15	15 m (49.2 ft)		Male	



## Brackets

LMB36RA

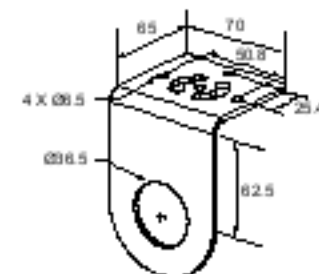
- Indicator light right-angle mounting
- 36 mm mounting hole
- Stainless steel



# Elevated Mount System

Model			Features	Components
Black Anodized Aluminum 1/4 in. NPT	Black Anodized Aluminum 1/2 in. NPT	Clear Anodized Aluminum 1/2 in. NPT		
SOP-E34-150A 150 mm (6 in) long	SOP-E12-150A 150 mm (6 in) long	SOP-E12-150AC 150 mm (6 in) long	<ul style="list-style-type: none"> <li>Elevated-use stand-off pipe</li> <li>Black anodized aluminum or clear anodized aluminum surface</li> <li>Threaded at both ends</li> <li>Compatible with most industrial environments</li> </ul>	
SOP-E34-300A 300 mm (12 in) long	SOP-E12-300A 300 mm (12 in) long	SOP-E12-300AC 300 mm (12 in) long		
SOP-E34-600A 600 mm (24 in) long	SOP-E12-600A 600 mm (24 in) long	—		
SOP-E34-900A 900 mm (36 in) long	SOP-E12-900A 900 mm (36 in) long	SOP-E12-900AC 900 mm (36 in) long		
SA-M36E12			<ul style="list-style-type: none"> <li>Adapter from M36 thread to 12-14 NPSM thread</li> <li>Streamlined black plastic mounting base adapter/cover</li> <li>Drilled hole</li> </ul>	
SA-M36SOP			<ul style="list-style-type: none"> <li>M36 thread adapter with clearance for 1/4 pipe mount</li> <li>Streamlined black plastic mounting base adapter/cover</li> <li>Drilled hole</li> </ul>	

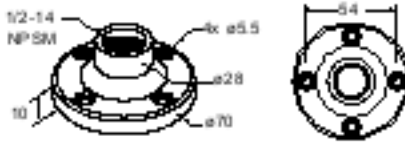
Pipe Mounting Flange			
Model	Description	Construction	
SA-F12	<ul style="list-style-type: none"> <li>Elevated-use stand-off pipes (1/2 in, NPSM/DN15)</li> <li>M5 mounting hardware and nitrile gasket included</li> </ul>	Die-cast zinc base with black paint	

# Pro Editor Hardware

<p>PRO-KIT</p> <p>Includes:</p> <ul style="list-style-type: none"> <li>Pro Converter Cable (MQDC-506-USB)</li> <li>Splitter (CSB-M1251FM1251M)</li> <li>Power Supply (PSW-24-1)</li> </ul>	
--	---

Chapter Contents

UTF-8 Encoding Table and Unicode Characters.....17  
 Clean with Mild Detergent and Warm Water.....21  
 Repairs.....21  
 Contact Us.....22  
 Banner Engineering Corp Limited Warranty.....22

# Chapter 6 Product Support and Maintenance

## UTF-8 Encoding Table and Unicode Characters

Unicode Code Point	Character	UTF-8 (hex.)	Name
U+0020		20	SPACE
U+0021	!	21	EXCLAMATION MARK
U+0022	"	22	QUOTATION MARK
U+0023	#	23	NUMBER SIGN
U+0024	\$	24	DOLLAR SIGN
U+0025	%	25	PERCENT SIGN
U+0026	&	26	AMPERSAND
U+0027	'	27	APOSTROPHE
U+0028	(	28	LEFT PARENTHESIS
U+0029	)	29	RIGHT PARENTHESIS
U+002A	*	2a	ASTERISK
U+002B	+	2b	PLUS SIGN
U+002C	,	2c	COMMA
U+002D	-	2d	HYPHEN-MINUS
U+002E	.	2e	FULL STOP
U+002F	/	2f	SOLIDUS
U+0030	0	30	DIGIT ZERO
U+0031	1	31	DIGIT ONE
U+0032	2	32	DIGIT TWO
U+0033	3	33	DIGIT THREE
U+0034	4	34	DIGIT FOUR
U+0035	5	35	DIGIT FIVE
U+0036	6	36	DIGIT SIX
U+0037	7	37	DIGIT SEVEN
U+0038	8	38	DIGIT EIGHT
U+0039	9	39	DIGIT NINE
U+003A	:	3a	COLON
U+003B	;	3b	SEMICOLON
U+003C	<	3c	LESS-THAN SIGN
U+003D	=	3d	EQUALS SIGN
U+003E	>	3e	GREATER-THAN SIGN

Continued on page 18

Continued from page 17

Unicode Code Point	Character	UTF-8 (hex.)	Name
U+003F	?	3f	QUESTION MARK
U+0040	@	40	COMMERCIAL AT
U+0041	A	41	LATIN CAPITAL LETTER A
U+0042	B	42	LATIN CAPITAL LETTER B
U+0043	C	43	LATIN CAPITAL LETTER C
U+0044	D	44	LATIN CAPITAL LETTER D
U+0045	E	45	LATIN CAPITAL LETTER E
U+0046	F	46	LATIN CAPITAL LETTER F
U+0047	G	47	LATIN CAPITAL LETTER G
U+0048	H	48	LATIN CAPITAL LETTER H
U+0049	I	49	LATIN CAPITAL LETTER I
U+004A	J	4a	LATIN CAPITAL LETTER J
U+004B	K	4b	LATIN CAPITAL LETTER K
U+004C	L	4c	LATIN CAPITAL LETTER L
U+004D	M	4d	LATIN CAPITAL LETTER M
U+004E	N	4e	LATIN CAPITAL LETTER N
U+004F	O	4f	LATIN CAPITAL LETTER O
U+0050	P	50	LATIN CAPITAL LETTER P
U+0051	Q	51	LATIN CAPITAL LETTER Q
U+0052	R	52	LATIN CAPITAL LETTER R
U+0053	S	53	LATIN CAPITAL LETTER S
U+0054	T	54	LATIN CAPITAL LETTER T
U+0055	U	55	LATIN CAPITAL LETTER U
U+0056	V	56	LATIN CAPITAL LETTER V
U+0057	W	57	LATIN CAPITAL LETTER W
U+0058	X	58	LATIN CAPITAL LETTER X
U+0059	Y	59	LATIN CAPITAL LETTER Y
U+005A	Z	5a	LATIN CAPITAL LETTER Z
U+005B	[	5b	LEFT SQUARE BRACKET
U+005C	\	5c	REVERSE SOLIDUS
U+005D	]	5d	RIGHT SQUARE BRACKET
U+005E	^	5e	CIRCUMFLEX ACCENT
U+005F	_	5f	LOW LINE
U+0060	`	60	GRAVE ACCENT
U+0061	a	61	LATIN SMALL LETTER A
U+0062	b	62	LATIN SMALL LETTER B
U+0063	c	63	LATIN SMALL LETTER C
U+0064	d	64	LATIN SMALL LETTER D
U+0065	e	65	LATIN SMALL LETTER E
U+0066	f	66	LATIN SMALL LETTER F
U+0067	g	67	LATIN SMALL LETTER G
U+0068	h	68	LATIN SMALL LETTER H

Continued on page 19

Continued from page 18

Unicode Code Point	Character	UTF-8 (hex.)	Name
U+0069	i	69	LATIN SMALL LETTER I
U+006A	j	6a	LATIN SMALL LETTER J
U+006B	k	6b	LATIN SMALL LETTER K
U+006C	l	6c	LATIN SMALL LETTER L
U+006D	m	6d	LATIN SMALL LETTER M
U+006E	n	6e	LATIN SMALL LETTER N
U+006F	o	6f	LATIN SMALL LETTER O
U+0070	p	70	LATIN SMALL LETTER P
U+0071	q	71	LATIN SMALL LETTER Q
U+0072	r	72	LATIN SMALL LETTER R
U+0073	s	73	LATIN SMALL LETTER S
U+0074	t	74	LATIN SMALL LETTER T
U+0075	u	75	LATIN SMALL LETTER U
U+0076	v	76	LATIN SMALL LETTER V
U+0077	w	77	LATIN SMALL LETTER W
U+0078	x	78	LATIN SMALL LETTER X
U+0079	y	79	LATIN SMALL LETTER Y
U+007A	z	7a	LATIN SMALL LETTER Z
U+007B	{	7b	LEFT CURLY BRACKET
U+007C		7c	VERTICAL LINE
U+007D	}	7d	RIGHT CURLY BRACKET
U+007E	~	7e	TILDE
U+00A0		c2 a0	NO-BREAK SPACE
U+00A1	¡	c2 a1	INVERTED EXCLAMATION MARK
U+00A2	¢	c2 a2	CENT SIGN
U+00A3	£	c2 a3	POUND SIGN
U+00A4	¤	c2 a4	CURRENCY SIGN
U+00A5	¥	c2 a5	YEN SIGN
U+00A6	¦	c2 a6	BROKEN BAR
U+00A7	§	c2 a7	SECTION SIGN
U+00A8	¨	c2 a8	DIAERESIS
U+00A9	©	c2 a9	COPYRIGHT SIGN
U+00AA	ª	c2 aa	FEMININE ORDINAL INDICATOR
U+00AB	«	c2 ab	LEFT-POINTING DOUBLE ANGLE QUOTATION MARK
U+00AC	¬	c2 ac	NOT SIGN
U+00AD		c2 ad	SOFT HYPHEN
U+00AE	®	c2 ae	REGISTERED SIGN
U+00AF	ˉ	c2 af	MACRON
U+00B0	°	c2 b0	DEGREE SIGN
U+00B1	±	c2 b1	PLUS-MINUS SIGN
U+00B2	²	c2 b2	SUPERSCRIP TWO
U+00B3	³	c2 b3	SUPERSCRIP THREE

Continued on page 20

Continued from page 19

Unicode Code Point	Character	UTF-8 (hex.)	Name
U+00B4	´	c2 b4	ACUTE ACCENT
U+00B5	µ	c2 b5	MICRO SIGN
U+00B6	¶	c2 b6	PILCROW SIGN
U+00B7	·	c2 b7	MIDDLE DOT
U+00B8	¸	c2 b8	CEDILLA
U+00B9	¹	c2 b9	SUPERSCRIPT ONE
U+00BA	º	c2 ba	MASCULINE ORDINAL INDICATOR
U+00BB	»	c2 bb	RIGHT-POINTING DOUBLE ANGLE QUOTATION MARK
U+00BC	¼	c2 bc	VULGAR FRACTION ONE QUARTER
U+00BD	½	c2 bd	VULGAR FRACTION ONE HALF
U+00BE	¾	c2 be	VULGAR FRACTION THREE QUARTERS
U+00BF	¿	c2 bf	INVERTED QUESTION MARK
U+00C0	À	c3 80	LATIN CAPITAL LETTER A WITH GRAVE
U+00C1	Á	c3 81	LATIN CAPITAL LETTER A WITH ACUTE
U+00C2	Â	c3 82	LATIN CAPITAL LETTER A WITH CIRCUMFLEX
U+00C3	Ã	c3 83	LATIN CAPITAL LETTER A WITH TILDE
U+00C4	Ä	c3 84	LATIN CAPITAL LETTER A WITH DIAERESIS
U+00C5	Å	c3 85	LATIN CAPITAL LETTER A WITH RING ABOVE
U+00C6	Æ	c3 86	LATIN CAPITAL LETTER AE
U+00C7	Ç	c3 87	LATIN CAPITAL LETTER C WITH CEDILLA
U+00C8	È	c3 88	LATIN CAPITAL LETTER E WITH GRAVE
U+00C9	É	c3 89	LATIN CAPITAL LETTER E WITH ACUTE
U+00CA	Ê	c3 8a	LATIN CAPITAL LETTER E WITH CIRCUMFLEX
U+00CB	Ë	c3 8b	LATIN CAPITAL LETTER E WITH DIAERESIS
U+00CC	Ì	c3 8c	LATIN CAPITAL LETTER I WITH GRAVE
U+00CD	Í	c3 8d	LATIN CAPITAL LETTER I WITH ACUTE
U+00CE	Î	c3 8e	LATIN CAPITAL LETTER I WITH CIRCUMFLEX
U+00CF	Ï	c3 8f	LATIN CAPITAL LETTER I WITH DIAERESIS
U+00D0	Ð	c3 90	LATIN CAPITAL LETTER ETH
U+00D1	Ñ	c3 91	LATIN CAPITAL LETTER N WITH TILDE
U+00D2	Ò	c3 92	LATIN CAPITAL LETTER O WITH GRAVE
U+00D3	Ó	c3 93	LATIN CAPITAL LETTER O WITH ACUTE
U+00D4	Ô	c3 94	LATIN CAPITAL LETTER O WITH CIRCUMFLEX
U+00D5	Õ	c3 95	LATIN CAPITAL LETTER O WITH TILDE
U+00D6	Ö	c3 96	LATIN CAPITAL LETTER O WITH DIAERESIS
U+00D7	×	c3 97	MULTIPLICATION SIGN
U+00D8	Ø	c3 98	LATIN CAPITAL LETTER O WITH STROKE
U+00D9	Ù	c3 99	LATIN CAPITAL LETTER U WITH GRAVE
U+00DA	Ú	c3 9a	LATIN CAPITAL LETTER U WITH ACUTE
U+00DB	Û	c3 9b	LATIN CAPITAL LETTER U WITH CIRCUMFLEX
U+00DC	Ü	c3 9c	LATIN CAPITAL LETTER U WITH DIAERESIS
U+00DD	Ý	c3 9d	LATIN CAPITAL LETTER Y WITH ACUTE

Continued on page 21

Continued from page 20

Unicode Code Point	Character	UTF-8 (hex.)	Name
U+00DE	þ	c3 9e	LATIN CAPITAL LETTER THORN
U+00DF	ß	c3 9f	LATIN SMALL LETTER SHARP S
U+00E0	à	c3 a0	LATIN SMALL LETTER A WITH GRAVE
U+00E1	á	c3 a1	LATIN SMALL LETTER A WITH ACUTE
U+00E2	â	c3 a2	LATIN SMALL LETTER A WITH CIRCUMFLEX
U+00E3	ã	c3 a3	LATIN SMALL LETTER A WITH TILDE
U+00E4	ä	c3 a4	LATIN SMALL LETTER A WITH DIAERESIS
U+00E5	å	c3 a5	LATIN SMALL LETTER A WITH RING ABOVE
U+00E6	æ	c3 a6	LATIN SMALL LETTER AE
U+00E7	ç	c3 a7	LATIN SMALL LETTER C WITH CEDILLA
U+00E8	è	c3 a8	LATIN SMALL LETTER E WITH GRAVE
U+00E9	é	c3 a9	LATIN SMALL LETTER E WITH ACUTE
U+00EA	ê	c3 aa	LATIN SMALL LETTER E WITH CIRCUMFLEX
U+00EB	ë	c3 ab	LATIN SMALL LETTER E WITH DIAERESIS
U+00EC	ì	c3 ac	LATIN SMALL LETTER I WITH GRAVE
U+00ED	í	c3 ad	LATIN SMALL LETTER I WITH ACUTE
U+00EE	î	c3 ae	LATIN SMALL LETTER I WITH CIRCUMFLEX
U+00EF	ï	c3 af	LATIN SMALL LETTER I WITH DIAERESIS
U+00F0	ð	c3 b0	LATIN SMALL LETTER ETH
U+00F1	ñ	c3 b1	LATIN SMALL LETTER N WITH TILDE
U+00F2	ó	c3 b2	LATIN SMALL LETTER O WITH GRAVE
U+00F3	ó	c3 b3	LATIN SMALL LETTER O WITH ACUTE
U+00F4	ô	c3 b4	LATIN SMALL LETTER O WITH CIRCUMFLEX
U+00F5	õ	c3 b5	LATIN SMALL LETTER O WITH TILDE
U+00F6	ö	c3 b6	LATIN SMALL LETTER O WITH DIAERESIS
U+00F7	÷	c3 b7	DIVISION SIGN
U+00F8	ø	c3 b8	LATIN SMALL LETTER O WITH STROKE
U+00F9	ù	c3 b9	LATIN SMALL LETTER U WITH GRAVE
U+00FA	ú	c3 ba	LATIN SMALL LETTER U WITH ACUTE
U+00FB	û	c3 bb	LATIN SMALL LETTER U WITH CIRCUMFLEX
U+00FC	ü	c3 bc	LATIN SMALL LETTER U WITH DIAERESIS
U+00FD	ý	c3 bd	LATIN SMALL LETTER Y WITH ACUTE
U+00FE	þ	c3 be	LATIN SMALL LETTER THORN
U+00FF	ÿ	c3 bf	LATIN SMALL LETTER Y WITH DIAERESIS

## Clean with Mild Detergent and Warm Water

Wipe down the device with a soft cloth dampened with a mild detergent and warm water solution. Do not use any other chemicals for cleaning.

## Repairs

Contact Banner Engineering for troubleshooting of this device. Do not attempt any repairs to this Banner device; it contains no field-replaceable parts or components. If the device, device part, or device component is determined to be defective by a Banner Applications Engineer, they will advise you of Banner's RMA (Return Merchandise Authorization) procedure.

**IMPORTANT:** If instructed to return the device, pack it with care. Damage that occurs in return shipping is not covered by warranty.

## Contact Us

Banner Engineering Corp. | 9714 Tenth Avenue North | Plymouth, MN 55441, USA | Phone: + 1 888 373 6767

For worldwide locations and local representatives, visit [www.bannerengineering.com](http://www.bannerengineering.com).

## Banner Engineering Corp Limited Warranty

Banner Engineering Corp. warrants its products to be free from defects in material and workmanship for one year following the date of shipment. Banner Engineering Corp. will repair or replace, free of charge, any product of its manufacture which, at the time it is returned to the factory, is found to have been defective during the warranty period. This warranty does not cover damage or liability for misuse, abuse, or the improper application or installation of the Banner product.

THIS LIMITED WARRANTY IS EXCLUSIVE AND IN LIEU OF ALL OTHER WARRANTIES WHETHER EXPRESS OR IMPLIED (INCLUDING, WITHOUT LIMITATION, ANY WARRANTY OF MERCHANTABILITY OR FITNESS FOR A PARTICULAR PURPOSE), AND WHETHER ARISING UNDER COURSE OF PERFORMANCE, COURSE OF DEALING OR TRADE USAGE.

This Warranty is exclusive and limited to repair or, at the discretion of Banner Engineering Corp., replacement. IN NO EVENT SHALL BANNER ENGINEERING CORP. BE LIABLE TO BUYER OR ANY OTHER PERSON OR ENTITY FOR ANY EXTRA COSTS, EXPENSES, LOSSES, LOSS OF PROFITS, OR ANY INCIDENTAL, CONSEQUENTIAL OR SPECIAL DAMAGES RESULTING FROM ANY PRODUCT DEFECT OR FROM THE USE OR INABILITY TO USE THE PRODUCT, WHETHER ARISING IN CONTRACT OR WARRANTY, STATUTE, TORT, STRICT LIABILITY, NEGLIGENCE, OR OTHERWISE.

Banner Engineering Corp. reserves the right to change, modify or improve the design of the product without assuming any obligations or liabilities relating to any product previously manufactured by Banner Engineering Corp. Any misuse, abuse, or improper application or installation of this product or use of the product for personal protection applications when the product is identified as not intended for such purposes will void the product warranty. Any modifications to this product without prior express approval by Banner Engineering Corp will void the product warranties. All specifications published in this document are subject to change; Banner reserves the right to modify product specifications or update documentation at any time. Specifications and product information in English supersede that which is provided in any other language. For the most recent version of any documentation, refer to: [www.bannerengineering.com](http://www.bannerengineering.com).

For patent information, see [www.bannerengineering.com/patents](http://www.bannerengineering.com/patents).

