

## Features

The Sure Cross R70ER Ethernet Data Radio is a compact, industrial, communication device used to create point-to-multipoint configurations of wireless Ethernet networks. The R70ER is available in two frequencies, 900 MHz and 2.4 GHz, and is fitted with D-Code M12 quick disconnect connectors for fast deployment.

- Star or tree network topology configuration
- DIP switches select operational modes
- No IP address configuration is required
- Frequency Hopping Spread Spectrum (FHSS) technology ensures reliable data delivery
- Self-healing, auto-routing radio frequency network with multiple hops to extend the network's range
- Advanced Encryption Standard (AES) using a 256-bit cryptographic key

For additional information, updated documentation, and a list of accessories, refer to Banner Engineering's website, [www.bannerengineering.com](http://www.bannerengineering.com).



## Models

Models	Frequency	Transmit Power
R70ER9MQ	900 MHz ISM Band	500 mW
R70ER2MQ	2.4 GHz ISM Band	65 mW (100 mW EIRP)

## Quick Start Guide

### Set Up Your R70ER Radio Network

Each radio network should include one controller/primary radio and several repeater or peripheral radios. To set up and install your wireless data radio network, follow these steps:

1. Before installing your Ethernet data radios, first verify that your Ethernet devices work.
  - a. Connect your devices using an Ethernet cable.
  - b. Configure the IP addresses of your devices and use a ping test with Ethernet cables to verify the connectivity before installing the radios.

This verifies the devices are configured correctly before replacing the cabled connection with a wireless connection.

2. Configure the DIP switches of the R70ER.
3. Apply power to all devices.
4. Form the wireless network by binding the repeater and peripheral radios to the controller/primary radio.
5. Observe the LED behavior to verify the devices are communicating with each other.
6. Verify the Ethernet devices work wirelessly.
  - a. Remove power to the R70 devices.
  - b. Connect your Ethernet devices to the R70 Ethernet Radios and apply power.
  - c. Run a ping test to confirm data is moving correctly through the wireless network.

# Configuration Instructions

## R70ER Buttons and LEDs

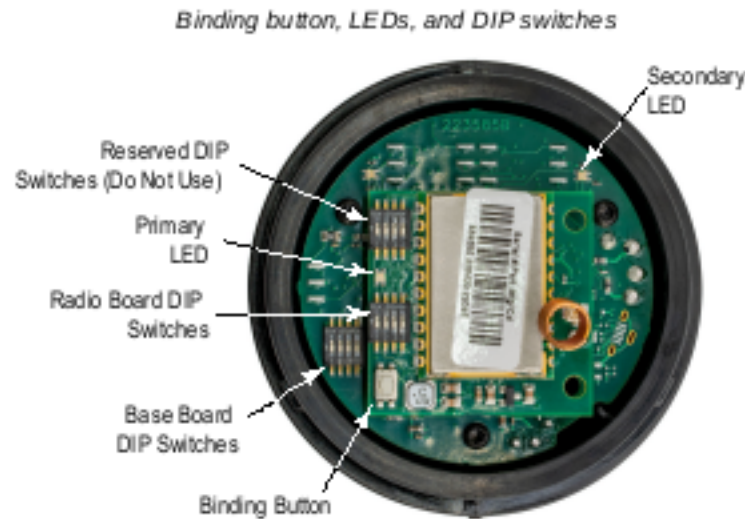

### Configure the R70ER DIP Switches

In any radio network, there is one client radio and there can be many server radios. Before changing the DIP switch positions, disconnect the power. Any changes made to the DIP switches are not recognized until after power is cycled to the device.

For parameters not set using the DIP switches, use the configuration software to make configuration changes. For parameters set using the DIP switches, the DIP switch positions override any changes made using the configuration software.

To configure the DIP switches:

1. If the R70ER is in the locked position, the arrow on the cover is above the notch on the base. Rotate the cover counterclockwise so that the notches are aligned together.
2. Pull the top cover off.
3. Set the DIP switches.

#### Base board DIP switch settings

Device Settings	DIP Switches			
	1	2	3	4
Set this radio to be one of many server radios	OFF	OFF		
Set this radio to be a repeater radio	OFF	ON		
Set this radio to be the client radio	ON	OFF		
Set this radio to be the client radio and suppress rebroadcast mode	ON	ON		
Standard XML Behavior - XML is obeyed			OFF	OFF
XML Bypassed - DHCP enabled			OFF	ON
Reserved			ON	OFF
XML Bypassed - Static IP 192.168.18.18 (server radio)	OFF		ON	ON
XML Bypassed - Static IP 192.168.17.17 (client radio)	ON		ON	ON

#### Radio board DIP switch settings (closest to binding button)

Radio Transmit Power (900 MHz Only)	DIP Switch
	4
500 mW (27 dBm) Default	OFF
250 mW (24 dBm)	ON

**Suppress Controller Re-broadcast**—The factory default setting is OFF (not selected). When not selected, the client device automatically re-broadcasts radio messages coming in from radio devices back out to the radio network when the destination address is not known. This affects server and repeater messages coming to the client that are unknown point-to-point messages and all broadcast-type messages. This allows for server devices to send messages to other server devices within the wireless network. If all messages originate from Ethernet devices connected to the client radio or when a wireless network only has a client and server device (one-to-one networks), this feature can be selected, suppressing re-broadcast messaging. In most cases, this switch will have minimal effect on radio network performance.

**Transmit Power Levels**—The 900 MHz radios transmit at 500 mW (27 dBm) or 250 mW (24 dBm). The 250 mW mode reduces the radio's range but improves the battery life in short-range applications. For 2.4 GHz models, this DIP switch is disabled. The transmit power for 2.4 GHz is fixed at about 65 mW EIRP (18 dBm).

**Star Topology**—To configure your radios as a star topology, set one radio to be the client (DIP switch 1 ON). Set all the other radios to be server radios.

**XML Behavior**—The R70 Ethernet radio is programmed similarly to a DXM Controller and uses a standard XML configuration file to define its settings. For troubleshooting purposes, or advanced use cases, the XML can be bypassed when the device is turned on. With the XML bypassed, the R70 will receive its own IP address, either fixed or through DHCP, according to the DIP switch settings.

## R70ER Network Topologies

In any radio network, there is one controller (Modbus client) radio and can be many repeater or peripheral (Modbus server) radios.

*Simple point to point network for cable replacement applications*



In this simple cable replacement application, the radio system knows all data originating at one end must be transmitted to the other end. This allows the radio system to automatically correct for transmission problems and it also provides the greatest throughput. This is the fastest configuration.

- Controller configuration route to peripherals: DIP switches 1 ON, 2 ON
- Peripheral configuration route to controller: DIP switches 1 OFF, 2 OFF

*Point to point network with repeater for cable replacement applications*



In this simple cable replacement application with repeater, the radio system still knows all data originating at one end must be transmitted to the other end. In this application, there are no Ethernet devices connected to the repeater(s). The system still corrects for transmission problems, but it takes time to repeat the message. The network delay is double that of a system with no repeater.

- Controller configuration route to peripheral: DIP switches 1 ON, 2 ON
- Repeater configuration: DIP switches 1 OFF, 2 ON
- Peripheral configuration route to controller: DIP switches 1 OFF, 2 OFF

*Star network in broadcast mode configuration*

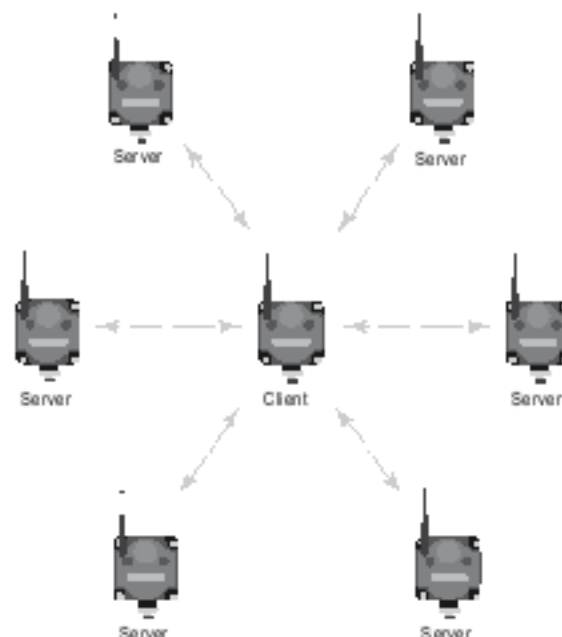

In this more complex star topology in broadcast mode, the controller radio at the center of the network can communicate to many peripheral radios. A common example would be a PLC at the center communicating with many remote I/O systems. The star topology is slower than a point-to-point network, but faster than a tree network.

- Controller configuration to broadcast to all devices: DIP switches 1 ON, 2 OFF

- Peripheral configuration to route to controller: DIP switches 1 OFF, 2 OFF

Tree network in broadcast mode configuration

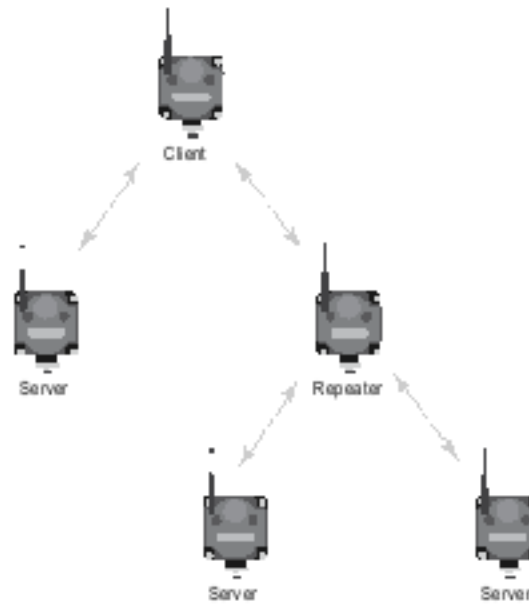

A tree network using MultiHop radios is the most powerful wireless system possible; many repeaters and peripheral radios can be combined to cover vast areas and get around hills or buildings. In the other networks, the wireless "hops" are minimized. In this system, you can "hop" as much as you need to, but the trade-off is speed. This is the slowest of the network layouts.

- Controller configuration to broadcast to all devices: DIP switches 1 ON, 2 OFF
- Repeater configuration to broadcast to all devices: DIP switches 1 OFF, 2 ON
- Peripheral configuration to broadcast to all devices: DIP switches 1 OFF, 2 OFF

**IMPORTANT:** Star and tree topologies use a Broadcast radio technique. Broadcasting allows for many radios and large complex systems but also introduces a small chance that a data packet can be lost. These networks topologies require the control system to automatically resend missing data packets. Most control protocols (like Modbus) will work fine. Other serial stream based protocols may not be as tolerant and should only be used with point to point topologies.

## Apply Power to the R70ER

The R70ER is fitted with a 4-pin M12 connector for fast installations. Use straight splitter cordsets to connect multiple devices and power to the R70ER. For a list of splitter and cordset options, see .

4-pin M12 Male Connector	Pin	Wire Color	Wiring Description
	1	Brown (bn)	10 to 30 V DC
	2	White (wh)	Reserved
	3	Blue (bu)	DC common (GND)
	4	Black (bk)	Reserved

## Bind the R70ER Ethernet Radio to Form a Network

To create your network, bind the R70 to the designated controller/primary radio.

Binding the radios ensures all radios within a network communicate only with the other radios within the same network. The data radio controller/primary automatically generates a unique binding code when the radio controller enters binding mode. This code is transmitted to all radios within range that are also in binding mode. After a repeater/peripheral radio is bound, the repeater/peripheral radio accepts data only from the controller to which it is bound. The binding code defines the network, and all radios within a network must use the same binding code.

- Apply power to all radios and place the R70ER radio at least two meters away from the controller/primary radio.
- Remove the cover. See ["Configure the R70ER DIP Switches" on page 2](#).
- On the controller/primary radio: Triple-click the binding button to enter binding mode. Both LEDs flash red.
- On the repeater/peripheral radio: Triple-click the binding button to put the R70ER into binding mode. The radio enters binding mode and searches for any controller/primary radio in binding mode. While searching for the controller/primary radio, the two red LEDs flash alternately. When the radio finds the controller/primary radio and is bound, both red LEDs are solid for four seconds, then both red LEDs flash simultaneously four times.
- Re-install the R70ER's cover.
- Repeat steps 3 through 5 for as many radios as are needed for your network.

7. On the controller/primary radio: After all radios are bound, double-click the binding button to exit binding mode.  
The network begins to form after the controller/primary data radio exits binding mode.
8. On the controller/primary radio: Re-install the cover to protect the button and radio board.

#### Child Radios Synchronize to the Parent Radios

The synchronization process enables a Sure Cross® radio to join a wireless network formed by a controller/primary radio. A simple point-to-point network with one controller/primary radio and one peripheral radio synchronizes quickly after power up; larger MultiHop networks may take a few minutes to synchronize. First, all radios within range of the controller radio wirelessly synchronize to the controller radio. These radios may be repeater radios or peripheral radios.

After repeater radios are synchronized to the controller radio, any radios that are not in sync with the controller but can "hear" the repeater radio will synchronize to the repeater radios. Each repeater "family" that forms a wireless network path creates another layer of synchronization process. When testing the devices before installation, verify the radio devices are at least two meters apart or the communications may fail.

## Client Radio LED Behavior

All bound radios set to operate as client radios follow this LED behavior after powering up.

Process Steps	Response	LED 1	LED 2
1	Apply power to the client radio	-	Solid amber
2	The client radio enters RUN mode.	Flashes green	-
	Data packets begin transmitting between the client and its children radios.	-	Flashes amber
	In binding mode	Flashes red	Flashes red

## Server Radio LED Behavior

All bound radios set to server or repeater modes follow this LED behavior after powering up.

Process Steps	Response	LED 1	LED 2
1	Apply power to the radio	-	Solid amber (briefly)
2	The server/repeater searches for a parent device.	Flashes red	-
3	A parent device is detected. The client/repeater searches for other parent radios within range.	Solid red	-
4	The server/repeater selects a suitable parent.	-	Solid amber
5	The server/repeater attempts to synchronize to the selected parent.	-	Solid red
6	The server/repeater is synchronized to the parent.	Flashes green	-
7	The server/repeater enters RUN mode.	Solid green, then flashes green	
	Data packets begin transmitting between the server/repeater and its parent radio.	-	Flashes amber
	In binding mode	Flashes red	Flashes red

## Installing Your Sure Cross® Radios

Please refer to one of these instruction manuals to install your wireless network components.

- DX80 Performance Wireless I/O Network Instruction Manual: [132607](#)
- MultiHop Data Radio Instruction Manual: [151317](#)

## Specifications

### Radio Range

A 2 dB antenna ships with this device.  
Transmit power and range are subject to many factors, including antenna gain, installation methods, characteristics of the application, and environmental conditions.  
Please refer to the following documents for installation instructions and high-gain antenna options.

- Installing Your Sure Cross® Radios ([151514](#))
- Conducting a Site Survey ([133602](#))
- Sure Cross® Antenna Basics ([132113](#))

### Radio Transmit Power

900 MHz Conducted: 27 dBm (500 mW); EIRP with the supplied antenna: < 36 dBm  
2.4 GHz Conducted: < 18 dBm (65 mW); EIRP with the supplied antenna: < 20 dBm (100 mW)

### Antenna Minimum Separation Distance

900 MHz radios transmitting at ≥ 500 mW: 4.57 m (15 ft) with the supplied antenna  
2.4 GHz, 65 mW: 0.3 m (1 ft)

### Spread Spectrum Technology

FHSS (Frequency Hopping Spread Spectrum)

Communication Protocols

Modbus® RTU, Modbus/TCP, EtherNet/IP™  
EtherNet/IP™ is a trademark of ODVA, Inc. Modbus® is a registered trademark of Schneider Electric USA, Inc.

Security Protocols

TLS, SSL, HTTPS

900 MHz Compliance (RM7023 Radio Module)

Radio module is indicated by the product label marking  
Contains FCC ID: UE3RM7023  
Contains IC: 7044A-RM7023



2.4 GHz Compliance (SX243 Radio Module)

Radio module is indicated by the product label marking  
Contains FCC ID: UE3SX243  
Radio Equipment Directive (RED) 2014/53/EU  
Contains IC: 7044A-SX243

Radio Data Transfer Rate

900 MHz: 300 kbps  
2.4 GHz: 250 kbps

Supply Voltage

10 V DC to 30 V DC (Outside the USA: 12 V DC to 24 V DC, ± 10%)  
For European applications, power this device from a Limited Power Source as defined in EN 60950-1.

Average Current for 900 MHz Radios (1500 byte packets at 50 ms intervals)

Client Mode: 0.12 A at 12 V; 0.06 A at 24 V  
Server Mode: 0.03 A at 12 V; 0.017 A at 24 V

Average Current for 2.4 GHz Radios (1500 byte packets at 50 ms intervals)

Client Mode: 0.035 A at 12 V; 0.02 A at 24 V  
Server Mode: 0.022 A at 12 V; 0.014 A at 24 V

Interface

Two bi-color LED indicators  
One button (under the small round cover)

Construction

Base: Black polycarbonate  
Cover: Translucent gray polycarbonate

Operating Conditions

-40 °C to +85 °C (-40 °F to +185 °F)  
95% maximum relative humidity (non-condensing)  
Radiated Immunity: 10 V/m (EN 61000-4-3)  
Operating the devices at the maximum operating conditions for extended periods can shorten the life of the device.

Environmental Ratings

IP65  
For installation and waterproofing instructions, go to [www.bannerengineering.com](http://www.bannerengineering.com) and search for the complete instruction manual

Shock and Vibration

All models meet IEC 60068-2-6 and IEC 60068-2-27 testing criteria  
Shock: 30G 11 ms duration, half sine wave per IEC 60068-2-27  
Vibration: 10 Hz to 55 Hz, 0.5 mm peak-to-peak amplitude per IEC 60068-2-6

Certifications



Agência Nacional de Telecomunicações 03737-22-04042

## FCC Part 15 Class A for Intentional Radiators

This equipment has been tested and found to comply with the limits for a Class A digital device, pursuant to Part 15 of the FCC Rules. These limits are designed to provide reasonable protection against harmful interference when the equipment is operated in a commercial environment. This equipment generates, uses, and can radiate radio frequency energy and, if not installed and used in accordance with the instruction manual, may cause harmful interference to radio communications. Operation of this equipment in a residential area is likely to cause harmful interference in which case the user will be required to correct the interference at his own expense.

(Part 15.21) Any changes or modifications not expressly approved by the party responsible for compliance could void the user's authority to operate this equipment.

## Industry Canada Statement for Intentional Radiators

This device complies with the licence exempt transmitter(s)/receiver(s) that comply with Innovation, Science and Economic Development Canada's licence exempt RSS(s). Operation is subject to the following two conditions:

- 1. This device may not cause interference.
- 2. This device must accept any interference, including interference that may cause undesired operation of the device.

Cet appareil conforme des émetteurs/récepteurs exempts de licence conformes à la norme Innovation, Sciences et Développement économique Canada. L'exploitation est autorisée aux deux conditions suivantes:

- 1. L'appareil ne doit pas produire de brouillage.
- 2. L'utilisateur de l'appareil doit accepter tout brouillage radioélectrique subi, même si le brouillage est susceptible d'en compromettre le fonctionnement.

## ANATEL

Este equipamento não tem direito à proteção contra interferência prejudicial e não pode causar interferência em sistemas devidamente autorizados. Para maiores informações, consulte o site da ANATEL [www.gov.br/anatel/pt-br/](http://www.gov.br/anatel/pt-br/)



# R70ER Dimensions

All measurements are listed in millimeters, unless noted otherwise. The measurements provided are subject to change.

Dimensions for the R70ER

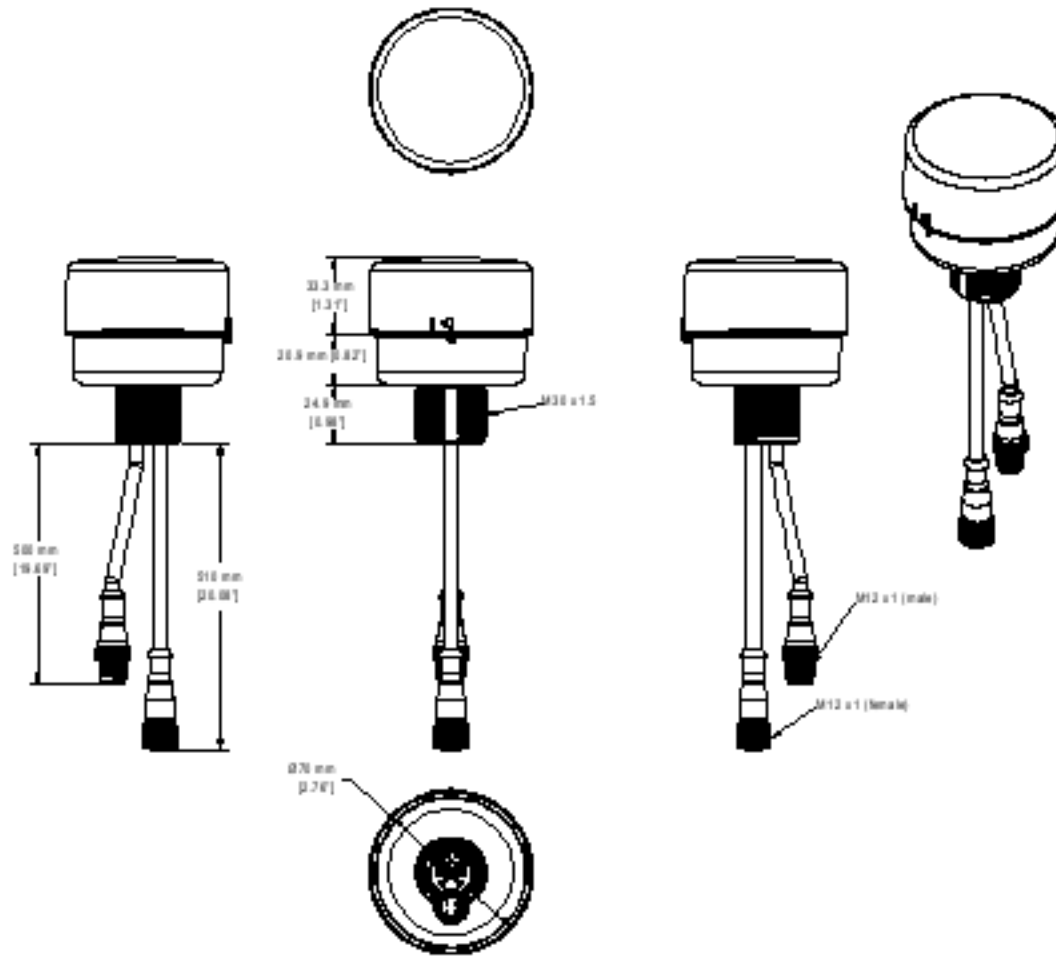

## Accessories

4-Pin Double-Ended M12 Female to M12 Male Cordsets				
Model	Length	Style	Dimensions	Pinout
MQDEC-401SS	0.31 m (1 ft)	Male Straight / Female Straight		<p>Female</p> <p>Male</p> <p>1 = Brown 2 = White 3 = Blue 4 = Black</p>
MQDEC-403SS	0.91 m (2.99 ft)			
MQDEC-406SS	1.83 m (6 ft)			
MQDEC-412SS	3.86 m (12 ft)			
MQDEC-415SS	4.58 m (15 ft)			
MQDEC-420SS	6.10 m (20 ft)			
MQDEC-430SS	9.14 m (30.2 ft)			
MQDEC-450SS	15.2 m (49.9 ft)	Male Right Angle / Female Straight		
MQDEC-403RS	0.91 m (2.99 ft)			
MQDEC-406RS	1.83 m (6 ft)			
MQDEC-412RS	3.86 m (12 ft)			
MQDEC-420RS	6.10 m (20 ft)			
MQDEC-430RS	9.14 m (30.2 ft)			
MQDEC-450RS	15.2 m (49.9 ft)			

Continued on page 8

Continued from page 7

4-Pin Double-Ended M12 Female to M12 Male Cordsets

Model	Length	Style	Dimensions	Pinout
MQDEC-403RR	0.9 m (2.9 ft)	Male Right-Angle / Female Right-Angle		
MQDEC-406RR	1.8 m (5.9 ft)			
MQDEC-412RR	3.6 m (11.8 ft)			
MQDEC-420RR	6.1 m (20 ft)			

4-Pin Single-Ended M12 Female Cordsets

Model	Length	Style	Dimensions	Pinout (Female)
MQDC-408	2 m (6.56 ft)	Straight		
MQDC-415	5 m (16.4 ft)			
MQDC-430	9 m (29.5 ft)			
MQDC-450	15 m (49.2 ft)			
MQDC-408RA	2 m (6.56 ft)	Right-Angle		
MQDC-415RA	5 m (16.4 ft)			
MQDC-430RA	9 m (29.5 ft)			
MQDC-450RA	15 m (49.2 ft)			

- 1 = Brown
- 2 = White
- 3 = Blue
- 4 = Black
- 5 = Unused





Double-Ended 4-pin M12 Male D-code to 8-Pin RJ45 Male Shielded Ethernet Cordsets

Model	Length	Dimensions	RJ45 Pinout (Male)	M12 Pinout (Male)
STP-M12D-403	0.9 m (2.95 ft)			
STP-M12D-406	1.83 m (6 ft)			
STP-M12D-415	4.57 m (15 ft)			
STP-M12D-430	9.14 m (30 ft)			

- 1 = White/Orange
- 2 = Orange
- 3 = White/Blue
- 6 = Blue

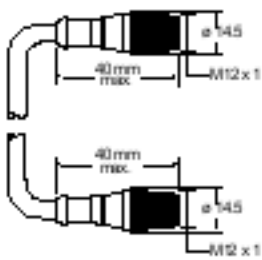
- 1 = White/Orange
- 2 = White/Blue
- 3 = Orange
- 4 = Blue

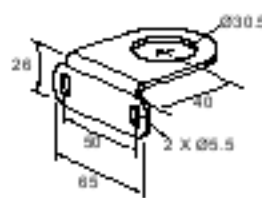
4-Pin D-Code Double-Ended M12 Male Ethernet Cordsets				
Model	Length	Style	Dimensions	Pinout (Male)
BCD-M12DM-M12DM-0.3M	0.3 m (13 in)	Straight		 <p>1 = White/Orange 2 = White/Green 3 = Orange 4 = Green</p>
BCD-M12DM-M12DM-1M	1 m (39 in)			
<b>WC-R70 Washdown Cover</b> <ul style="list-style-type: none"> <li>FDA-grade silicone</li> <li>Fits R70 data radios</li> <li>IP67 and IP69K rated</li> </ul>				
<b>LMB30LP</b> <ul style="list-style-type: none"> <li>Low profile</li> <li>30 mm mounting hole</li> <li>300 series stainless steel</li> </ul>				

## Warnings



### WARNING:

- Do not use this device for personnel protection.
- Using this device for personnel protection could result in serious injury or death.
- This device does not include the self-checking redundant circuitry necessary to allow its use in personnel safety applications. A device failure or malfunction can cause either an energized (on) or de-energized (off) output condition.

**IMPORTANT:** Please download the complete Sure Cross R70ER Ethernet Data Radio technical documentation, available in multiple languages, from [www.banner-engineering.com](http://www.banner-engineering.com) for details on the proper use, applications, warnings, and installation instructions of this device.

**IMPORTANT:** Por favor descargue desde [www.banner-engineering.com](http://www.banner-engineering.com) toda la documentación técnica de los Sure Cross R70ER Ethernet Data Radio, disponibles en múltiples idiomas, para detalles del uso adecuado, aplicaciones, advertencias, y las instrucciones de instalación de estos dispositivos.

**IMPORTANT:** Veuillez télécharger la documentation technique complète des Sure Cross R70ER Ethernet Data Radio sur notre site [www.banner-engineering.com](http://www.banner-engineering.com) pour les détails sur leur utilisation correcte, les applications, les notes de sécurité et les instructions de montage.

Install and properly ground a qualified surge suppressor when installing a remote antenna system. Remote antenna configurations installed without surge suppressors invalidate the manufacturer's warranty. Keep the ground wire as short as possible and make all ground connections to a single-point ground system to ensure no ground loops are created. No surge suppressor can absorb all lightning strikes; do not touch the Sure Cross® device or any equipment connected to the Sure Cross® device during a thunderstorm.

**Exporting Sure Cross® Radios.** It is our intent to fully comply with all national and regional regulations regarding radio frequency emissions. Customers who want to re-export this product to a country other than that to which it was sold must ensure the device is approved in the destination country. The Sure Cross wireless products were certified for use in these countries using the antenna that ships with the product. When using other antennas, verify you are not exceeding the transmit power levels allowed by local governing agencies. This device has been designed to operate with the antennas listed on Banner Engineering's website and having a maximum gain of 9 dBi. Antennas not included in this list or having a gain greater than 9 dBi are strictly prohibited for use with this device. The required antenna impedance is 50 ohms. To reduce potential radio interference to other users, the antenna type and its gain should be so chosen such that the equivalent isotropically radiated power (EIRP) is not more than that permitted for successful communication. Consult with Banner Engineering Corp. if the destination country is not on this list.

### IMPORTANT:

- Never operate a radio without connecting an antenna.
- Operating radios without an antenna connected will damage the radio circuitry.
- To avoid damaging the radio circuitry, never apply power to a Sure Cross® Performance or Sure Cross® Multi-Tag radio without an antenna connected.

**IMPORTANT:**

- Electrostatic discharge (ESD) sensitive device
- ESD can damage the device. Damage from inappropriate handling is not covered by warranty.
- Use proper handling procedures to prevent ESD damage. Proper handling procedures include leaving devices in their anti-static packaging until ready for use; wearing anti-static wrist straps; and assembling units on a grounded, static-dissipative surface.

## Banner Engineering Corp Limited Warranty

Banner Engineering Corp. warrants its products to be free from defects in material and workmanship for one year following the date of shipment. Banner Engineering Corp. will repair or replace, free of charge, any product of its manufacture which, at the time it is returned to the factory, is found to have been defective during the warranty period. This warranty does not cover damage or liability for misuse, abuse, or the improper application or installation of the Banner product.

THIS LIMITED WARRANTY IS EXCLUSIVE AND IN LIEU OF ALL OTHER WARRANTIES WHETHER EXPRESS OR IMPLIED (INCLUDING, WITHOUT LIMITATION, ANY WARRANTY OF MERCHANTABILITY OR FITNESS FOR A PARTICULAR PURPOSE), AND WHETHER ARISING UNDER COURSE OF PERFORMANCE, COURSE OF DEALING OR TRADE USAGE.

This Warranty is exclusive and limited to repair or, at the discretion of Banner Engineering Corp., replacement. IN NO EVENT SHALL BANNER ENGINEERING CORP. BE LIABLE TO BUYER OR ANY OTHER PERSON OR ENTITY FOR ANY EXTRA COSTS, EXPENSES, LOSSES, LOSS OF PROFITS, OR ANY INCIDENTAL, CONSEQUENTIAL OR SPECIAL DAMAGES RESULTING FROM ANY PRODUCT DEFECT OR FROM THE USE OR INABILITY TO USE THE PRODUCT, WHETHER ARISING IN CONTRACT OR WARRANTY, STATUTE, TORT, STRICT LIABILITY, NEGLIGENCE, OR OTHERWISE.

Banner Engineering Corp. reserves the right to change, modify or improve the design of the product without assuming any obligations or liabilities relating to any product previously manufactured by Banner Engineering Corp. Any misuse, abuse, or improper application or installation of this product or use of the product for personal protection applications when the product is identified as not intended for such purposes will void the product warranty. Any modifications to this product without prior express approval by Banner Engineering Corp will void the product warranties. All specifications published in this document are subject to change; Banner reserves the right to modify product specifications or update documentation at any time. Specifications and product information in English supersede that which is provided in any other language. For the most recent version of any documentation, refer to: [www.bannerengineering.com](http://www.bannerengineering.com).

For patent information, see [www.bannerengineering.com/patents](http://www.bannerengineering.com/patents).