

Product Description

Simple, reliable, volume and height monitoring with ZMX Series 3D Time of Flight Sensor. Patent pending.

This guide is designed to help you set up and install the ZMX Series 3D Time of Flight Sensor. For complete information on programming, performance, troubleshooting, dimensions, and accessories, please refer to the Instruction Manual at www.bannerengineering.com. Search for part number 230551 to view the Instruction Manual. Use of this document assumes familiarity with pertinent industry standards and practices.

WARNING:

- Do not use this device for personnel protection
- Using this device for personnel protection could result in serious injury or death.
- This device does not include the self-checking redundant circuitry necessary to allow its use in personnel safety applications. A device failure or malfunction can cause either an energized (on) or de-energized (off) output condition.

Features and Indicators

LED indicators provide ongoing indication of sensing status.

Features

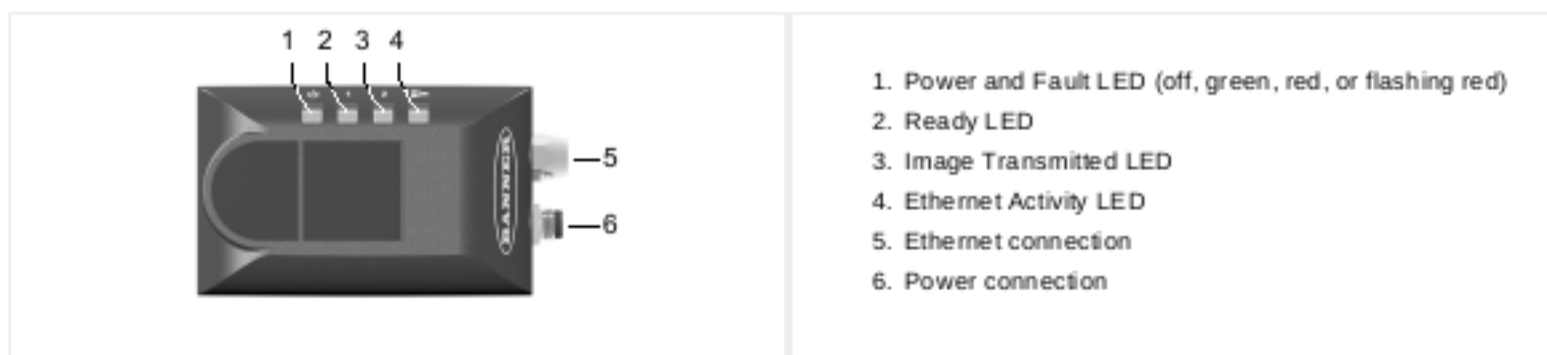

Laser Description and Safety Information

CAUTION:

- Return defective units to the manufacturer.
- Use of controls or adjustments or performance of procedures other than those specified herein may result in hazardous radiation exposure.
- Do not attempt to disassemble this sensor for repair. A defective unit must be returned to the manufacturer.

Class 1 lasers are lasers that are safe under reasonably foreseeable conditions of operation, including the use of optical instruments for intrabeam viewing.

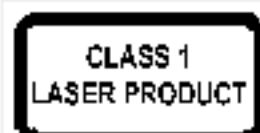

Complies with 21 CFR 1040.10 and 1040.11, except for deviations pursuant to Laser Notice No. 56, dated May 8, 2019.
Complies with IEC 60825-1:2014 and EN 60825-1:2014+A11:2021.

Installation Instructions

Mount the Device

1. If a bracket is needed, mount the device onto the bracket.
2. Mount the device (or the device and the bracket) to the machine or equipment at the desired location. Do not tighten the mounting screws at this time.

CAUTION: This device accepts M4 screws. Engaging the screws more than 4 mm will damage the device.

CAUTION: 8 in·lbf (0.904 Nm) maximum torque

3. Check the device alignment.
4. Tighten the mounting screws to secure the device (or the device and the bracket) in the aligned position.

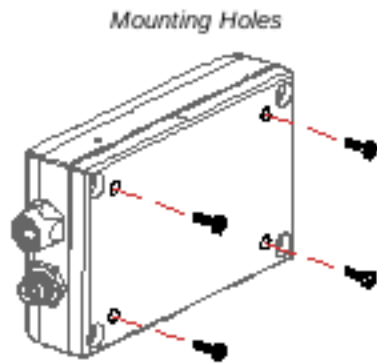

NOTE: Do not remove the housing screws.

NOTE: Provide adequate dissipation of heat. A good heat conductor, such as aluminum, may be required.

Mounting Surface Thickness	Length of Mounting Screws
≤ 2 mm	4 mm
2 mm to 4 mm	6 mm
4 mm to 6 mm	8 mm

Wiring

To maintain the ratings listed in the Specifications, the ZMX Series 3D Time of Flight Sensor requires using a specific type of shielded cable. Refer to the Instruction Manual's accessories list for more information.

Tighten the cables finger tight only.

Channel 1 as PNP Output, Channel 2 as Trigger Input

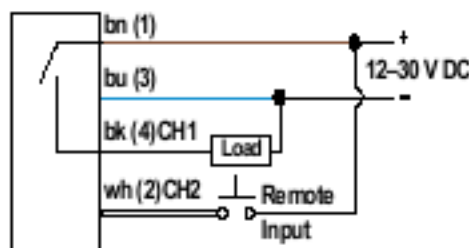

Channel 1 as NPN Output, Channel 2 as Trigger Input

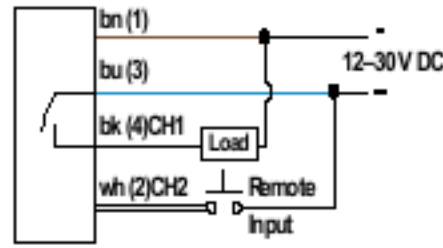

M8 Male Connector



Power and I/O Pinouts

Pin	Wire Color	Description
1	Brown	12 V DC to 30 V DC
2	White	Trigger Input or Output (selectable PNP, NPN, or push pull)
3	Blue	Common
4	Black	Output (selectable PNP, NPN, or push pull)

Install the Software

Use the following instructions to install the Banner 3D Configuration software on your computer.

PC Requirements

Operating System	Memory (RAM)
Microsoft® Windows® operating system version 8, 10, or 11 ⁽¹⁾	500 MB
Hard Drive Space	Ports Needed
100 MB	TCP/IP port 32000
Screen Resolution	TCP/IP port 32200
1024 × 768 pixels	UDP/IP Port 19995

⁽¹⁾ Microsoft and Windows are registered trademarks of Microsoft Corporation in the United States and/or other countries.

IMPORTANT: Administrative rights may be required to install the Banner 3D Configuration software.

1. Download the latest version of the software from www.bannerengineering.com.
2. Navigate to and open the downloaded file.
3. Run the downloaded installer.
4. Check the agreement for license terms and conditions.
5. Click Install to install the software.
A Windows security message displays. This indicates that the installer is signed and is from Banner.
6. Click Yes.
7. Click Close to exit the installer when the installation is complete.
8. Locate the program icon on the desktop or in the Start menu and open the Banner 3D Configuration software.

Getting Started

Connect to the Sensor

These instructions use Windows® operating system version 8, 10, or 11.⁽²⁾

1. Confirm the network connections.
 - a. Click the Start button, then on the Start menu, click Control Panel.
 - b. In Control Panel, click Network and Internet, then click Network and Sharing Center, and then click Change adapter settings.
 - c. Right-click on the connection that you want to change, then click Properties.
If you are prompted for an administrator password or confirmation, enter the password or provide confirmation.
 - d. In the connection properties, click Internet Protocol Version 4 (TCP/IPv4), and then click Properties.
 - e. In the Internet Protocol (TCP/IPv4) Properties, select Use the following IP address.
 - f. Make sure that the IP address is 192.168.0.2 (or an unused IP address within the 192.168.0.x subnet), and the subnet mask is 255.255.255.0.
2. Open the Banner 3D Configuration software from the desktop or the Start menu.
3. Connect to the ZMX sensor using one of the following options:
 - * From the Connection pane, enter the IP address of the desired ZMX sensor into the Sensor IP Address field, then click Connect.
 - * From the Connection pane, locate the IP address of the desired sensor in the list of discovered sensors, then click  next to IP Address.

The default IP address for the sensor is 192.168.0.10.

Banner 3D Configuration Workspace

The Banner 3D Configuration software displays the information needed to modify sensor parameters.

⁽²⁾ Windows is a registered trademark of Microsoft Corporation in the United States and/or other countries.

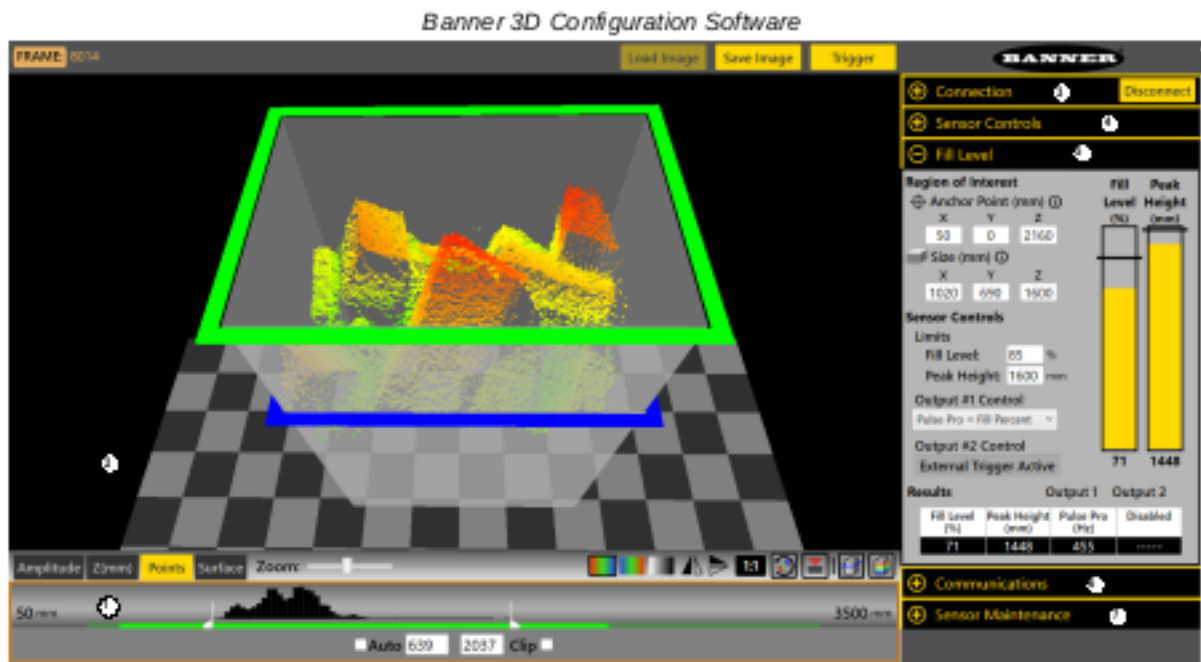

The workspace is divided into several panes.

1. Image Pane Parameters—Includes zoom; x, y, z coordinates; image color; view selection (Amplitude, Z(mm), Points, Surface). The options vary depending on the selected view.
2. Image pane—Displays the current image captured by the sensor and includes the buttons:
 - * Load Image—Loads a previously saved file for viewing while disconnected from the sensor
 - * Save Image—Save file as a .3f
 - * Trigger—Manually triggers the sensor when Trigger mode is set to External or Software
3. Connection pane—Enables connection to a sensor and includes settings and information related to the sensor’s IP address.
4. Sensor Controls pane—Controls the trigger mode and illumination output.
5. Fill Level pane— Includes options for the region of interest and sensor controls, as well as live fill and peak height data.
6. Communications pane—Sets the communication protocol and DHCP option for the sensor.
7. Sensor Maintenance pane—Includes sensor information and options to update the firmware, restore the sensor to the default settings, to backup the current sensor settings, or restore the sensor to previously saved settings.

ZMX Specifications

Sensing Range

- 200 mm to 2500 mm (7.9 in to 8.2 ft) on a 90% reflectance white target
- 200 mm to 2500 mm (7.9 in to 8.2 ft) on a 20% reflectance gray target
- 200 mm to 1700 mm (7.9 in to 5.6 ft) on a 6% reflectance black target

Supply Voltage

- 12 V DC to 30 V DC
- Current: 200 mA average, 2.5 A peak (exclusive of load and lights)
- Use only with a suitable Class 2 power supply, or current-limiting power supply rated 12 V DC to 30V DC, 2.5 A

Discrete I/O Configuration

- Channel 1: Push-pull, PNP or NPN discrete output, or Pulse Pro/Pulse Frequency Modulation (PFM) output
- Channel 2: PNP or NPN discrete output, or Pulse Pro/Pulse Frequency Modulation (PFM) output, or remote trigger

Flatness (Pixel-to-Pixel Accuracy)

- ±20 mm for > 10x excess gain
- ±60 mm for 2x to 10x excess gain

Response Time

- 150 ms in Free Run mode

Accuracy

- ±30 mm for > 10x excess gain⁽¹⁾

⁽¹⁾ For 6% to 90% diffuse targets in the center 25% of the field of view; ±60 mm accuracy for 2x to 10x excess gain.

Repeatability (1-sigma)

- Peak excess gain: 2 mm
- > 10x excess gain, 10 mm
- > 2x excess gain, 40 mm

Communication Interface

- Ethernet; 100 Mbps

Communication Protocol

- Modbus® TCP/IP
- EtherNet/IP™
- Modbus® is a registered trademark of Schneider Electric USA, Inc. EtherNet/IP™ is a trademark of ODVA, Inc.

Boresighting

- ±20 mm at 1 m range

Delay at Power Up

- < 10 s

Recommended Warm Up Time

- 15 minutes

Light Source

- Infrared, 850 nm

Temperature Effect

- < 0.5 mm/°C

Resolution

- 272 horizontal × 208 vertical pixels

Field of View

- 60 horizontal × 45 vertical degrees

Reading Rate, Full Resolution

- Up to 6 frames per second in Free Run mode

- Ambient Light Immunity
10,000 lux
- Torque—Tapped Holes for Mounting Screws
8 in-lbf (0.904 Nm) maximum torque
- Torque—Cables
Only finger tighten the connectors
Minimize cable pull or hanging weight, including right-angle installations
- Construction
Housing: Aluminum
Lens Cover: Acrylic with optical coating
Light Pipe: Polycarbonate
- Connections
4-pin M8 male for power and discrete I/O
4-pin M8 female for Ethernet
- Storage Conditions
-30 °C to +65 °C (-22 °F to +149 °F)
- Operating Conditions
-10 °C to +40 °C (+14 °F to +104 °F), assuming adequate mounting and ventilation
- Environmental Rating
IP65 per IEC60529
- Vibration
MIL-STD-202G, Method 201A (Vibration: 10 Hz to 55 Hz, 0.06 inch (1.52 mm) double amplitude, 2 hours each along X, Y and Z axes), with device operating
- Shock
MIL-STD-202G, Method 213B, Condition I (100G 6x along X, Y, and Z axes, 18 shocks), with device operating
- Weight
205 g
- Output Rating
Current rating: 50 mA maximum

White wire specifications per configuration		
PNP	Output High	$\geq V_{supply} - 2.5 V$
	Output Low	$\leq 2.5 V$ (loads $\leq 70 k\Omega$)
NPN	Output High	$\geq V_{supply} - 2.5 V$
	Output Low	$\leq 2.5 V$

Required Overcurrent Protection

WARNING: Electrical connections must be made by qualified personnel in accordance with local and national electrical codes and regulations.

Overcurrent protection is required to be provided by end product application per the supplied table. Overcurrent protection may be provided with external fusing or via Current Limiting, Class 2 Power Supply. Supply wiring leads < 24 AWG shall not be spliced. For additional product support, go to www.bannerengineering.com.

Supply Wiring (AWG)	Required Overcurrent Protection (A)	Supply Wiring (AWG)	Required Overcurrent Protection (A)
20	5.0	26	1.0
22	3.0	28	0.8
24	1.0	30	0.5

Certifications

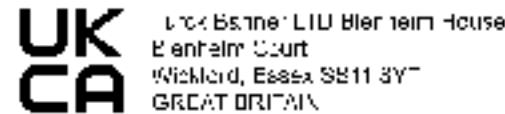

Advanced Capabilities



Refer to the Instruction Manual, p/n 230551, for FCC and Industry Canada notification statements.

Banner Engineering Corp Limited Warranty

Banner Engineering Corp. warrants its products to be free from defects in material and workmanship for one year following the date of shipment. Banner Engineering Corp. will repair or replace, free of charge, any product of its manufacture which, at the time it is returned to the factory, is found to have been defective during the warranty period. This warranty does not cover damage or liability for misuse, abuse, or the improper application or installation of the Banner product.

THIS LIMITED WARRANTY IS EXCLUSIVE AND IN LIEU OF ALL OTHER WARRANTIES WHETHER EXPRESS OR IMPLIED (INCLUDING, WITHOUT LIMITATION, ANY WARRANTY OF MERCHANTABILITY OR FITNESS FOR A PARTICULAR PURPOSE), AND WHETHER ARISING UNDER COURSE OF PERFORMANCE, COURSE OF DEALING OR TRADE USAGE.

This Warranty is exclusive and limited to repair or, at the discretion of Banner Engineering Corp., replacement. IN NO EVENT SHALL BANNER ENGINEERING CORP. BE LIABLE TO BUYER OR ANY OTHER PERSON OR ENTITY FOR ANY EXTRA COSTS, EXPENSES, LOSSES, LOSS OF PROFITS, OR ANY INCIDENTAL, CONSEQUENTIAL OR SPECIAL DAMAGES RESULTING FROM ANY PRODUCT DEFECT OR FROM THE USE OR INABILITY TO USE THE PRODUCT, WHETHER ARISING IN CONTRACT OR WARRANTY, STATUTE, TORT, STRICT LIABILITY, NEGLIGENCE, OR OTHERWISE.

Banner Engineering Corp. reserves the right to change, modify or improve the design of the product without assuming any obligations or liabilities relating to any product previously manufactured by Banner Engineering Corp. Any misuse, abuse, or improper application or installation of this product or use of the product for personal protection applications when the product is identified as not intended for such purposes will void the product warranty. Any modifications to this product without prior express approval by Banner Engineering Corp will void the product warranties. All specifications published in this document are subject to change; Banner reserves the right to modify product

specifications or update documentation at any time. Specifications and product information in English supersede that which is provided in any other language. For the most recent version of any documentation, refer to: www.bannerengineering.com.

For patent information, see www.bannerengineering.com/patents.

Banner Engineering Corp. Software Copyright Notice

© Banner Engineering Corp., All Rights Reserved.

<https://www.bannerengineering.com/us/en/company/terms-and-conditions.html>

Disclaimer of Warranties. This software is provided "AS-IS." To the maximum extent permitted by applicable law, Banner, its affiliates, and its channel partners disclaim all warranties, expressed or implied, including any warranty that the software is fit for a particular purpose, title, merchantability, data loss, non-interference with or non-infringement of any intellectual property rights, or the accuracy, reliability, quality or content in or linked to the services. Banner and its affiliates and channel partners do not warrant that the services are secure, free from bugs, viruses, interruption, errors, theft or destruction. If the exclusions for implied warranties do not apply to you, any implied warranties are limited to 60 days from the date of first use of this software.

Limitation of Liability and Indemnity. Banner, its affiliates and channel partners are not liable for indirect, special, incidental, punitive or consequential damages, damages relating to corruption, security, loss or theft of data, viruses, spyware, loss of business, revenue, profits, or investment, or use of software or hardware that does not meet Banner minimum systems requirements. The above limitations apply even if Banner and its affiliates and channel partners have been advised of the possibility of such damages. This Agreement sets forth the entire liability of Banner, its affiliates and your exclusive remedy with respect to the software use.

Document title: ZMX Series 3D Time of Flight Sensor Quick Start Guide

Part number: 229164

Revision: C

Original Instructions

© Banner Engineering Corp. All rights reserved.



229164