

Wireless Accessories



Antennas.....	page 2
Antenna Cables.....	page 4
Batteries	page 5
Brackets	page 6
Communications Cables	page 8
Enclosures and Panels.....	page 9
Hardware Packets.....	page 10
I-O Expansion	page 11
Power Cordsets.....	page 12
Power Supplies	page 17
Sensors.....	page 18
Solar Panels	page 21

Antennas

Select your antenna based on your specific application needs. There are three basic antenna solutions:

- Use the supplied rubber duck antenna inside the enclosure. DX80 products come with a 2 dBi rubber duck antenna. Often simply attaching the supplied antenna to the radio provides enough radio range to meet your needs.
- Mount a dome antenna to the enclosure. The -D antennas can be mounted directly on the enclosure.
- Use an N-type pole-mounted antenna, with surge suppressor. The -A and -AS antennas can be mounted remotely from the enclosure and require the BWC-LFNBMN-DC surge suppressor.

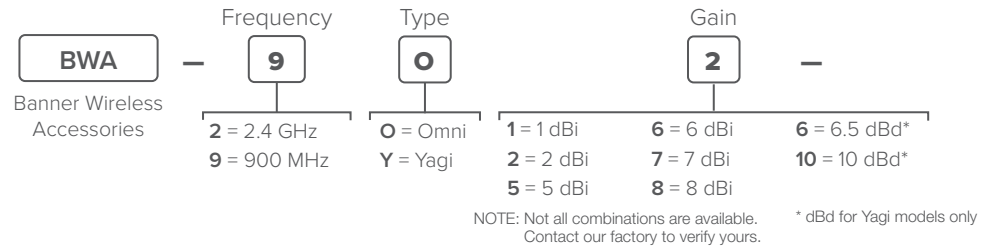

Omni-Directional



BWA-2O1-001	2.4 GHz	1 dBi, Rubber, 1 in tall, RP-SMA connection
BWA-2O2-C	2.4 GHz	2 dBi, Rubber swivel, 3 1/4 in (ships with 2.4 GHz radios), RP-SMA connection
BWA-2O5-C	2.4 GHz	5 dBi, Rubber swivel, 6 1/2 in, RP-SMA connection
BWA-2O7-C	2.4 GHz	7 dBi, Rubber swivel, 9 1/4 in, RP-SMA connection
BWA-9O2-C	900 MHz	2 dBi, Rubber swivel (ships with 900 MHz radios), RP-SMA connection
BWA-9O5-C	900 MHz	5 dBi, Rubber swivel, RP-SMA connection
BWA-9O2-RA	900 MHz	2 dBi, Rubber fixed right-angle, RP-SMA connection
BWA-9O2-RA2	900 MHz	2 dBi 1/2 wave, Rubber fixed right-angle, 160 mm tall, RP-SMA connection
BWA-2O2-001	2.4 GHz	2 dBi, 18 inch cable, 1/2" SS NPT Port
BWA-2O2-002	2.4 GHz	2 dBi, 18 inch cable, 3/4" SS NPT Port
BWA-2O2-D	2.4 GHz	2 dBi, 18 inch cable, RP-SMA Box Mount
BWA-9O2-001	900 MHz	2 dBi, 18 inch cable, 1/2" SS NPT Port
BWA-9O2-002	900 MHz	2 dBi, 18 inch cable, 3/4" SS NPT Port
BWA-9O2-D	900 MHz	2 dBi, 18 inch cable, RP-SMA Box Mount



BWA-2O6-A	2.4 GHz	6 dBi, Fiberglass, 16 in (shown), N-Type connection
BWA-2O8-A	2.4 GHz	8.5 dBi, Fiberglass, 24 in, N-Type connection
BWA-9O6-A	900 MHz	6 dBi, Fiberglass, N-Type connection
BWA-9O6-AS	900 MHz	6 dBi, Fiberglass, 1/4 Wave, 23.6 in (1.3 inch diameter), N-Type connection
BWA-9O8-AS	900 MHz	8 dBi, Fiberglass, 3/4 Wave, 63 in (1.5 inch diameter), N-Type connection



Yagi

BWA-9Y6-A	900 MHz	6.5 dBd, 6.8 × 13 inches Outdoor, N-Type connection
BWA-9Y10-A	900 MHz	10 dBd, 6.8 × 24 inches Outdoor, N-Type connection



Cellular (CDMA multi band)

BWA-CELLA-002	2 dBi, 6.3 in blade style, RP-SMA male connection	
----------------------	---	--

Antenna Cables



Antenna Cables: RP-SMA to RP-SMA

BWC-1MRSFRSB0.2	RG58, RP-SMA Male to RP-SMA Female Bulkhead, 0.2 m
BWC-1MRSFRSB1	RG58, RP-SMA Male to RP-SMA Female Bulkhead, 1 m
BWC-1MRSFRSB2	RG58, RP-SMA Male to RP-SMA Female Bulkhead, 2 m
BWC-1MRSFRSB4	RG58, RP-SMA Male to RP-SMA Female Bulkhead, 4 m
BWC-2MRSFRS3	LMR200, RP-SMA Male to RP-SMA Female, 3 m
BWC-2MRSFRS6	LMR200, RP-SMA Male to RP-SMA Female, 6 m
BWC-2MRSFRS9	LMR200, RP-SMA Male to RP-SMA Female, 9 m
BWC-2MRSFRS12	LMR200, RP-SMA Male to RP-SMA Female, 12 m

Antenna Cables: RP-SMA to N-Type

BWC-1MRSMN05	LMR100 RP-SMA to N-Type Male, 0.5 m
BWC-1MRSMN2	LMR100 RP-SMA to N-Type Male, 2 m

Antenna Cables: N-Type

BWC-4MNFN3	LMR400 N-Type Male to N-Type Female, 3 m
BWC-4MNFN6	LMR400 N-Type Male to N-Type Female, 6 m
BWC-4MNFN15	LMR400 N-Type Male to N-Type Female, 15 m
BWC-4MNFN30	LMR400 N-Type Male to N-Type Female, 30 m

Surge Suppressors

BWC-LFNBMN-DC	Surge Suppressor, bulkhead, N-Type Female, N-Type Male, dc Blocking
BWC-LMRSFRPB	Surge Suppressor, bulkhead, RPSMA to RP-SMA

Antenna Housing

BWA-HW-016	Antenna Feedthrough, Stainless Steel, 1/2" NPT
-------------------	--

BWA-HW-017	Antenna Feedthrough, Stainless Steel 3/4" NPT
-------------------	---

Batteries



BWA-BATT-001

3.6 V Lithium D cell for hazardous or nonhazardous locations, one battery



BWA-BATT-006

3.6 V Lithium AA cell, two batteries



BWA-BATT-011

3.6 V Lithium D cell for non-hazardous locations only, one battery



BWA-BATT-013

3.6 V Lithium C cell, one battery



DX81-LITH

Battery Supply Module with mounting hardware



DX81P6

Battery Supply Module, six "D" cells, with mounting hardware

Brackets



BWA-BK-004

- Mounts both the K50U Ultrasonic sensor and a Wireless Q45U Node or DX80 Node



BWA-BK-006

- Mounts both the K50U Ultrasonic sensor and a Wireless Q45U Node



BWA-BK-008

- Magnetic coaxial mount for round objects
- Includes SMB42FLAT stainless steel bracket, 1/4"-28 screw mount, and 1 piece of 3M™ thermally conductive adhesive transfer tape 42 mm × 42 mm



BWA-BK-009

- Mounts the device to a surface using two-part epoxy
- Alignment mark indicates the front of device
- Includes a base plate, two screw retainers, four mounting screws, a set screw, and a mounting disc



BWA-BK-010

- Includes a magnetic mounting bracket and four mounting screws
- 44.5 mm × 49.5 mm
- SmCo magnet with a 40 lb pull strength
- For use on flat or curved surfaces



BWA-BK-011

- Backside magnetic mount for the Q45 Sensors
- Includes one bracket, three screws, and a magnetic cup
- 60 mm × 40 mm
- For use on a flat surface

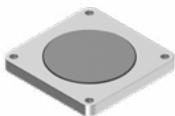

BWA-BK-013

- Includes magnetic mounting bracket SMBQM30 and four mounting screws (two sets of mounting screws for both the aluminum and stainless steel models)
- 30 mm × 30 mm



BWA-BK-019

- Magnet mount for curved surfaces
- 30 mm × 30 mm, 14.4 mm thick
- Includes four M2.5 × 16 mm socket head cap screws

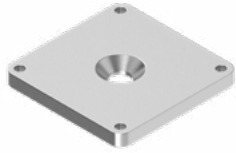

BWA-BK-022

- Use when measuring high frequency vibrations or when mounting the sensor to curved surfaces
- Includes SMBQM30 aluminum bracket, four mounting screws, one ¼-28 × 1/2 screw mount, and one piece of 3M™ thermally conductive adhesive transfer tape
- 30 mm × 30 mm
- Refer to the Bracket Assembly Quick Start Guide for installation instructions (p/n 213323)



BWA-BK-024

- Disk Vibration Mount
- 10-32 thread 25 mm diameter
- Stainless steel



BWA-BK-025

- Includes a magnetic mounting bracket and four mounting screws
- For use on flat or curved surfaces
- SmCo magnet with a 40 lb pull strength
- 44.5 mm × 54 mm; 15.6 mm thick



BWA-BK-026

- Includes a base plate, two screw retainers, four mounting screws, a set screw, and a mounting disc
- Mounts the device to a surface using two-part epoxy
- Alignment mark indicates the front of device
- 44.5 mm × 54 mm



SMBAMS18RA

- Right-angle SMBAMS series bracket with 18 mm hole
- Articulation slots for 90+° rotation
- 12-ga. (2.6 mm) cold-rolled steel



SMBDX80DIN

- Black reinforced thermoplastic bracket for mounting on a 35 mm DIN rail

Communication Cables



BWA-DRSPLITTER

DB9 Splitter Cable, Splitter cable, DB9 Female (RS232) trunk to 5-pin M12 male and female - 11.8 inch branches and trunk



BWA-E2M

Ethernet cable, RSCD RJ45 440, 2 m



BWA-E8M

Ethernet cable, RSCD RJ45 440, 8 m

BWA-EX2M

Ethernet cable, crossover, RSCD RJ45CR 440, 2 m



BWA-HW-006

Adapter cable, USB to RS-485, for use with the User Configuration Tool software (UCT)



BWA-UCT-900

Adapter cable with power, USB to RS-485, for use with the User Configuration Tool software (UCT), supplies power to 1 Watt radios



BWA-USB1WIRE-001

PC USB to 1-wire Serial Interface converter. Use with the Sensor Configuration Tool software to communicate directly with 1-wire Serial Interface sensors



BWA-HW-026

Splitter cable with a wall plug to supply external power to a MultiHop Radio operating at 1 Watt while it is connected to a computer

BWA-RIBBON-001

Ribbon cable, 20-pin DBL socket

Enclosures and Panels



BWA-AH66SPK	Swing Panel Kit, 6 × 6 in, Includes Mounts, Screws, and Panel
BWA-AH86SPK	Swing Panel Kit, 8 × 6 in, Includes Mounts, Screws, and Panel
BWA-AH108SPK	Swing Panel Kit, 8 × 10 in, Includes Mounts, Screws, and Panel
BWA-AH1210SPK	Swing Panel Kit, 12 × 10 in, Includes Mounts, Screws, and Panel
BWA-AH1412SPK	Swing Panel Kit, 14 × 12 in, Includes Mounts, Screws, and Panel
BWA-AH1614SPK	Swing Panel Kit, 16 × 14 in, Includes Mounts, Screws, and Panel
BWA-AH1816SPK	Swing Panel Kit, 18 × 16 in, Includes Mounts, Screws, and Panel
BWA-BP66A	Back Panel, aluminum, 6 × 6 in
BWA-BP86A	Back Panel, aluminum, 6 × 6 in
BWA-BP108A	Back Panel, aluminum, 8 × 10 in
BWA-BP1210A	Back Panel, aluminum, 12 × 10 in
BWA-BP1412A	Back Panel, aluminum, 14 × 12 in
BWA-BP1614A	Back Panel, aluminum, 16 × 14 in
BWA-BP1816A	Back Panel, aluminum, 18 × 16 in
BWA-EF866	Enclosure Fiberglass Hinged 8 × 6 × 6 in
BWA-EF1086	Enclosure Fiberglass Hinged 10 × 8 × 6 in
BWA-PANEL86	Panel, 8 × 6 in
BWA-PANEL108	Panel, 10 × 8 in
BWA-AH6DR	Din Rail Kit 6 in (Includes 2 Tribolar Screws and DIN Rail)
BWA-AH8DR	Din Rail Kit 8 in (Includes 2 Tribolar Screws and DIN Rail)
BWA-AH10DR	Din Rail Kit 10 in (Includes 2 Tribolar Screws and DIN Rail)
BWA-AH12DR	Din Rail Kit 12 in (Includes 2 Tribolar Screws and DIN Rail)
BWA-AH14DR	Din Rail Kit 14 in (Includes 2 Tribolar Screws and DIN Rail)
BWA-AH16DR	Din Rail Kit 16 in (Includes 2 Tribolar Screws and DIN Rail)
BWA-AH18DR	Din Rail Kit 18 in (Includes 2 Tribolar Screws and DIN Rail)
DIN-35-70	35 mm DIN Rail Track, 70 mm length track
DIN-35-105	35 mm DIN Rail Track, 105 mm length track
DIN-35-140	35 mm DIN Rail Track, 140 mm length track
DIN-35-180	35 mm DIN Rail Track, 180 mm length track
DIN-35-220	35 mm DIN Rail Track, 220 mm length track
BWA-AHTBS	DIN Rail Kit, Trilobular/self-threading screws, #10-32 × 0.375 PHL PH ZINC, 10 pack

Hardware Packets



BWA-CG.5-2X2.5-10

Cable Glands, 1/2-in NPT, Cordgrip for 2 holes of 1.2 to 2.5 mm diameter, 10 Pack



BWA-CG.5-10

Cable Glands, 1/2-in NPT, Cordgrip for 3 holes of 2.8 to 5.6 mm diameter, 10 Pack



BWA-CG.5-3X5.6-10

Cable Glands, 1/2-in NPT, Cordgrip for 3 holes of 2.8 to 5.6 mm diam, 10 Pack



BWA-CG.5-6X3.0-10

Cable Glands, 1/2-in NPT, Cordgrip for 6 holes of 1.5 to 3 mm diameter, 10 Pack



BWA-CG.5-6X4.0-10

Cable Glands, 1/2-in NPT, Cordgrip for 6 holes of 2 to 4 mm diameter, 10 Pack



BWA-HW-052

Cable Gland Pack: 1/2-in NPT gland, 1/2-inch NPT multi-cable gland, and 1/2-inch NPT vent plug



BWA-HW-053

Plug Conduit, Plastic Hex, 1/2-14 NPT, for 1.2 to 2.5 mm dia



BWA-HW-031

Vent Plug, 1/2-in NPT, IP67



BWA-HW-032

Access hardware for the E housing, one 1/2-inch plug, one 1/2-inch gland



BWA-HW-034

- DIN rail clip, black plastic
- Used with the M-HBx MultiHop and -PBx Performance board modules

BWA-AHAK

Accessory Kit: includes all screws, inserts and mounting feet (replacement only)

I-O Expansion



<p>DX85M0P0M4M4</p>	<p>DX85 Modbus RTU Remote I/O, 4 Analog IN, 4 Analog OUT (0 to 20 mA)</p>
<p>DX85M4P4M2M2</p>	<p>DX85 Modbus RTU Remote I/O, 4 Discrete IN, 4 Discrete OUT, 2 Analog IN, 2 Analog OUT (0 to 20 mA)</p>
<p>DX85M-P8</p>	<p>DX85 Modbus RTU Remote I/O, Up to 12 sourcing inputs or up to 12 sourcing outputs (for a total of 12 I/O)</p>
<p>BWA-RELAY-12V</p>	<p>Relay, Blade Style with Base, 12 V</p>
<p>BWA-RELAY-24V</p>	<p>Relay, Blade Style with Base, 24 V</p>
<p>BWA-RH1B-UDC12V</p>	<p>Relay, Blade Style, No Base, 12 V (replacement part)</p>
<p>BWA-RH1B-UDC24V</p>	<p>Relay, Blade Style, No Base, 24 V (replacement part)</p>
<p>BWA-SH1B-05</p>	<p>Relay Base Only (replacement part)</p>
<p>IB6RP</p>	<p>Interface Relay Box, 18 to 26 V dc inputs, isolated relay outputs (not shown)</p>



NOTE: Add a "C" to the end of any DX85 model to order that I/O mix with an IP20 housing. The IP20 models are Class I, Division 2 certified when installed in a suitable enclosure.

Power Cordsets

Pre-wired



Model	Style
BWA-QD5.5	Prewired 5-pin M12 quick disconnect (QD), 1/2-14 NBSM
BWA-QD8.5	Prewired 8-pin M12 quick disconnect (QD), 1/2-14 NBSM
BWA-QD12.56	Prewired 12-pin M12 quick disconnect (QD), 1/2-14 NBSM

M12 — Single-Ended

Right-angle cordsets are not compatible with the DX70 devices. When facing the Node or Gateway toward you and the quick-disconnect connection is facing down, the right-angle cables exit to the right.

When using the FlexPower® Node with integrated battery, use a double-ended cordset. When using a FlexPower Node with external power supply, use a single-ended cordset. If using the communication lines, the cable length cannot exceed 3 meters (10 ft).



Model	Length	Style	Dimensions	Pinout
MQDC1-501.5	0.50 m (1.5 ft)	Straight		<p>Female</p> <p>1 = Brown 2 = White 3 = Blue 4 = Black 5 = Gray</p>
MQDC1-506	1.83 m (6 ft)			
MQDC1-515	4.57 m (15 ft)			
MQDC1-530	9.14 m (30 ft)			
MQDC1-506RA	1.83 m (6 ft)	Right-Angle		
MQDC1-515RA	4.57 m (15 ft)			
MQDC1-530RA	9.14 m (30 ft)			

M12 — Double-Ended

Right-angle cordsets are not compatible with the DX70 devices. When facing the Node or Gateway toward you and the quick-disconnect connection is facing down, the right-angle cables exit to the right.

When using the FlexPower® Node with integrated battery, use a double-ended cordset. When using a FlexPower Node with external power supply, use a single-ended cordset. If using the communication lines, the cable length cannot exceed 3 meters (10 ft).



Model	Length	Style	Dimensions	Pinout
MQDEC-501SS	0.31 m (1.02 ft)	Straight		<p>Male</p> <p>Female</p> <p>1 = Brown 2 = White 3 = Blue 4 = Black 5 = Gray</p>
MQDEC-503SS	0.91 m (2.99 ft)			
MQDEC-506SS	1.83 m (6 ft)			
MQDEC-512SS	3.66 m (12 ft)			

Splitter Cables

Use CSRB-M1250M125.47M125.73 to split power between two FlexPower® or solar powered devices. DO NOT use this cable to connect a FlexPower devices to a 10 to 30 V dc powered device.

Use CSRB-M1253.28M1253.28M1253.28 to connect one FlexPower device (data radio, FlexPowered Gateway, etc) to two power sources, such as the FlexPower Solar Supply and DX81P6 Battery Pack.



Model	Length	Style	Pinout
CSRB-M1250M125.47M125.73	Trunk: 0 m (male) Branches: 0.14 m and 0.22 m (female)	Straight	 <p>1 = Brown 2 = White 3 = Blue 4 = Black 5 = Green/Yellow</p>

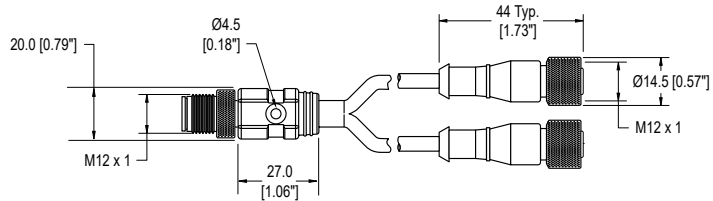

CSRB-M1253.28M1253.28M1253.28	Trunk: 1 m (female) Branches: 1 m (male)	Straight	 <p>1 = Brown 2 = White 3 = Blue 4 = Black 5 = Green/Yellow</p>
-------------------------------	---	----------	---

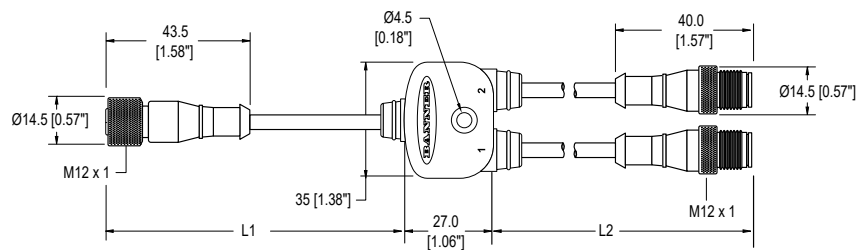

Power Cordsets (continued)



Model	Length	Style	Pinout
CSB-M1240M1240	Trunk: None Branches: None	Straight	 <p>1 = Brown 2 = White 3 = Blue 4 = Black</p>

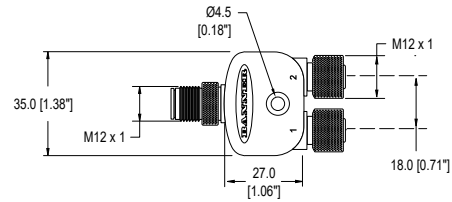

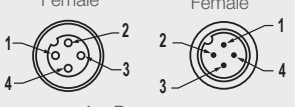
Model	Length	Style	Pinout
CSB-M1240M1241	Trunk: None (male) Branches: 0.3 m (female)	Straight	 <p>1 = Brown 2 = White 3 = Blue 4 = Black</p>

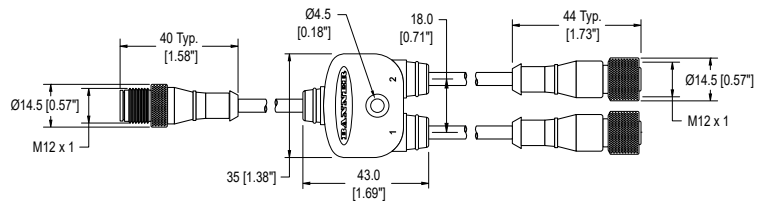



Model	Length	Style	Pinout
CSB-M1241M1241	Trunk: 0.30 m (male) Branch: 2 x 0.30 m (female)	Straight	<p>Female Female</p> <p>1 = Brown 2 = White 3 = Blue 4 = Black</p>
CSB-M1248M1241	Trunk: 2.50 m (male) Branch: 2 x 0.30 m (female)	Straight	
CSB-M12415M1241	Trunk: 4.57 m (male) Branch: 2 x 0.30 m (female)	Straight	
CSB-M21425M1241	Trunk: 7.60 m (male) Branch: 2 x 0.30 m (female)	Straight	
CSB-UNT425M1241	Trunk: 7.60 m Unterminated	Straight	

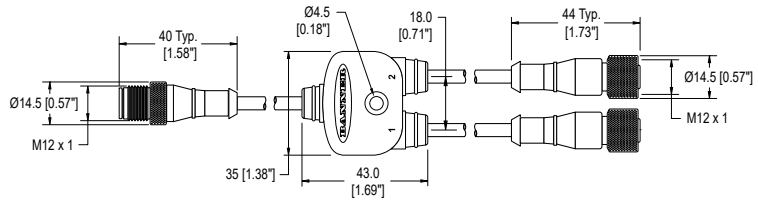

CSB4-M1251M1250	Branches: 0.0 Trunk: 0.3	No trunk	<p>Male Female</p> <p>1 = Brown 2 = White 3 = Blue 4 = Black 5 = Gray</p>
-----------------	-----------------------------	----------	--

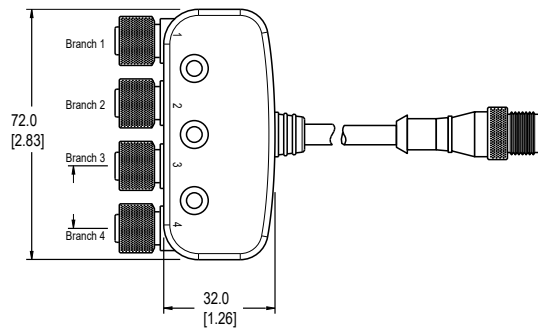

Power Cordsets (continued)



Model	Length	Style	Pinout
CSB-M1250M1250-T	2 x 0.30 m (1 ft)	0.30 m (1 ft)	<p>1 = Brown 2 = White 3 = Blue 4 = Black</p>

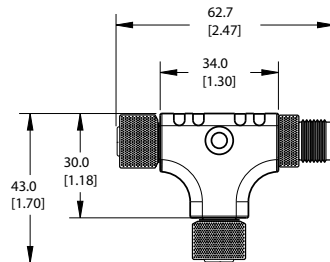

Receptacle



Model	Style	Dimensions	Pinout
BWA-HW-027	8-pin quick disconnect, female, 1/2-inch NPT (FK8-0.5/14.5/NPT)		

Connector



Model	Style	Dimensions	Pinout
FIC-M12F4	4-pin M12/Euro-style straight female field-wireable connector		

Power Supplies



PSD-24-4

DC power supply with wall plug, 90-264 V AC 50/60 Hz input, 24 V DC output, US-style wall plug input, 4-pin M12/Euro-style output; 2 m (6 ft) cable, UL Listed Class 2



PSDINP-24-06

DC power supply, 0.63 Amps, 24 V DC, with DIN Rail Mount, Class I Division 2 (Groups A, B, C, D) Rated

PSDINP-24-13

DC power supply, 1.3 Amps, 24 V DC, with DIN Rail Mount, Class I Division 2 (Groups A, B, C, D) Rated

PSDINP-24-25

DC power supply, 2.5 Amps, 24 V DC, with DIN Rail Mount, Class I Division 2 (Groups A, B, C, D) Rated



PSW-24-1

DC power supply with wall plug, 100-240 V AC 50/60 Hz input, 24 V DC 1 A output, UL Listed Class 2

PSWB-24-1

DC power supply with multi-blade wall plug, 100-240 V AC 50/60 Hz input, 24 V DC 1 A output, UL Listed Class 2, barrel jack connector

Sensors

Sensors with a Serial Interface



QM30VT1

- Vibration and Temperature Sensor
- Aluminum housing
- 2.09 m (6.85 ft) cable with a 5-pin M12 male quick disconnect (QD)

QM30VT1-QP

- Vibration and Temperature Sensor
- Aluminum housing
- 150 mm (6 in) cable with a 5-pin M12 male quick disconnect (QD)

QM30VT1-SS

- Vibration and Temperature Sensor
- Stainless steel housing
- 2.09 m (6.85 ft) cable with a 5-pin M12 male quick disconnect (QD)



K50UX1ARA

- 1-wire serial interface ultrasonic sensor
- Range: 100 mm to 1 m (3.94 in to 39.4 in)

K50UX1CRA

- 1-wire serial interface ultrasonic sensor
- Range: 300 mm to 3 m (11.8 in to 118 in)



M12FTH4Q

- Temperature and humidity sensor
- ±2% Accuracy, 1-wire serial interface
- (Requires a 5-pin threaded M12 double-ended cordset less than 3 meters long, such as model DEE2R-5xD.)

M12FT4Q

- Temperature sensor
- 1-wire serial interface
- (Requires a 5-pin threaded M12 double-ended cordset less than 3 meters long, such as model DEE2R-5xD.)

Sensors with Modbus Interface



QM30VT2

- Vibration and temperature sensor, RS-485 Modbus interface
- Detects dual-axis vibration
- Aluminium housing
- 3 m cable with a 5-pin M12/Euro-style male quick disconnect (QD)

QM30VT2-SS-QP

- Vibration and temperature sensor, RS-485 Modbus interface
- Detects dual-axis vibration
- 316L stainless steel housing
- 150 mm (6 in) PVC cable with a 5-pin M12/Euro-style male quick disconnect (QD)

QM30VT2-SS-9M

- Vibration and temperature sensor, RS-485 Modbus interface
- Detects dual-axis vibration
- 316L stainless steel housing
- 9.1 m (30 ft) cable with flying leads



K50UX1CRA

- Modbus Slave device via RS-485
- Range: 100 mm to 1 m (3.94 in to 39.4 in)

K50UX2CRA

- Modbus Slave Device via RS-485
- Range: 300 mm to 3 m (11.8 in to 118 in)



M12FTH3Q

- Temperature and humidity sensor with RS-485 Modbus interface

M12FT3Q

- Temperature sensor with RS-485 Modbus interface

GPS50M

- 2.5 m positional accuracy
- IP69K per DIN40050
- 5-30 V DC Supply Voltage

1.5.3 Thermistor, Pressure, Moisture, and CT Sensors



BWA-625-10000-1-1-8-25

- NoShok Series 625 Intrinsically Safe Pressure Transmitter, model 625-10000-1-1-8-25
- 0 to 10000 psig, 4–20 mA
- 1/2" NPT, M12 QD, FM and CSA approved

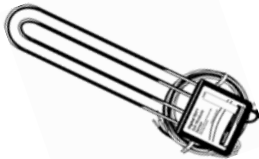

BWA-ACC-SEN-SDI

- Acclima SDI-12 Soil Moisture Transducer



BWA-CURRENT-TRANSFORMER-150A

- Split-Core Current Transformer
- 5–150 A Input, 0.333 V Output

BWA-CURRENT-TRANSFORMER-20A

- Split-Core Current Transformer
- 5–20 A Input, 0.333 V Output



BWA-PRESSURE-SENSOR-15L

- 0-15 PSIG (10.5 m depth)
- 60 ft cable with vent tube

Sensors (continued)

	BWA-PRESSURE-SENSOR-50	<ul style="list-style-type: none"> • 0–50 PSIG • 1 meter flying leads • 1/4"-18 NPT port
	BWA-PRESSURE-SENSOR-500	<ul style="list-style-type: none"> • 0–500 PSIS • 1 meter flying leads
	BWA-PRESSURE-SENSOR-3000	<ul style="list-style-type: none"> • 0–3000 PSIG • 1 meter flying leads
	BWA-S612-15-100	<ul style="list-style-type: none"> • NoShok Series 612 Submersible Level Transmitter, model 612-15-1-1-N-100 • 0 to 15 psig, 100 foot cable
	BWA-THERMISTOR-001	<ul style="list-style-type: none"> • NTC Thermistor • 2.2 KOhms, +/-0.2%C, blue bead • For models: DX80N9X2S2N2T/C, DX99N9X2S2N0T4X0A0, and DX99N9X1S2N0T4X0D0
	BWA-THERMISTOR-002	<ul style="list-style-type: none"> • NTC Thermistor • 10 KOhms, +/-0.2%C, black bead • For Performance models -P1/C/E, and MultiHop models MH1/C/E- 2 pack
	BWA-THERMISTOR-PROBE-003	<ul style="list-style-type: none"> • Temperature sensor with thermistor PS103G2 • Beta Value(K) 0–50°C: 3575, Base thermistor accuracy of 0.2% • Operating Temperature Range: –20 °C to +105 °C (–4 °F to +221 °F) • Maximum Power Rating: 30 mW at 25 °C; derated to 1 mW at 125 °C • Dissipation Constant: 1 mW/°C, • Stainless steel finish; PVC insulation
	FTH-FIL-001	Filter for Temperature/Humidity Sensor Aluminum grill filter cap default filter
	FTH-FIL-002	Filter for Temperature/Humidity Sensor stainless steel sintered to 10µm porosity for high dust environments

Solar Panels



BWA-SOLAR CNTRL-12V

Solar Controller, 6 A Load Current, 12 V System Voltage, recommended for 20 W or less solar panel and a Sealed Lead Acid Battery (sold separately)

BWA-SOLAR PANEL 20W

Solar Panel, 12 V, 20 W, Multicrystalline, 573 × 357 × 30, "L" style mounting bracket included (does not include controller)

BWA-SOLAR PANEL 3W

Solar Panel, 12 V, 3 W, Multicrystalline, 188 × 195 × 15, Wall/Pole clamp style mounting bracket included (does not include controller)

BWA-SOLAR PANEL 5W

Solar Panel, 12 V, 5 W, Multicrystalline, 270 × 222 × 17, Wall/Pole clamp style mounting bracket included (does not include controller)

