

T30

Installation Sheet

Einbauhinweise
Consiglio d'installazione
Conseils d'installation
取扱説明書
Folleto de instalación



TYPE	DESCRIPTION	BESCHREIBUNG	DESCRIZIONE	DESCRIPTION	検出距離・モード	DESCRIPCIÓN	
T30-SP6-LP	6 m Polarized retro-reflective	6 m Reflexlichtsch. mit polarisationsfilter	6 m Catarifrangenti con filtro polarizzatore	6 m Rétro-réfléctif avec filtre de polarisation	6 m 偏光回帰反射形	6 m Retroreflex con filtro de polarización	
T30-SP6-LP-Q							
T30-SN6-LP							
T30-SN6-LP-Q							
T30-SP6-FF200	200 mm Fixed-field	200 mm Refl.taster m. Hintergrundaubl.	200 mm A soppressione di sfondo	200 mm Suppression de l'arrière-plan	200 mm 距離設定反射形	200 mm Supresión de fondo	
T30-SP6-FF200-Q							
T30-SP6-FF400	400 mm Fixed-field	400 mm Refl.taster m. Hintergrundaubl.	400 mm A soppressione di sfondo	400 mm Suppression de l'arrière-plan	400 mm 距離設定反射形	400 mm Supresión de fondo	
T30-SP6-FF400-Q							
T30-SN6-FF200	200 mm Fixed-field	200 mm Refl.taster m. Hintergrundaubl.	200 mm A soppressione di sfondo	200 mm Suppression de l'arrière-plan	200 mm 距離設定反射形	200 mm Supresión de fondo	
T30-SN6-FF200-Q							
T30-SN6-FF400	400 mm Fixed-field	400 mm Refl.taster m. Hintergrundaubl.	400 mm A soppressione di sfondo	400 mm Suppression de l'arrière-plan	400 mm 距離設定反射形	400 mm Supresión de fondo	
T30-SN6-FF400-Q							
T30-6-E	60 m Opposed emitter	60 m Einweglichtschranke sender	60 m Barriera emettitori	60 m Barrière émetteur	60 m 透過形 投光器	60 m Barrera emisor	
T30-SP6-R							
T30-SN6-R	Opposed receiver	Einweglichtschranke empfänger	Barriera ricevitori	Barrière récepteur	透過形 受光器	Barrera receptor	
T30-6-E-Q							
T30-SP6-R-Q	60 m Opposed emitter	60 m Einweglichtschranke sender	60 m Barriera emettitori	60 m Barrière émetteur	60 m 透過形 投光器	60 m Barrera emisor	
T30-SN6-R-Q							
T30-SP6-R-Q	Opposed receiver	Einweglichtschranke empfänger	Barriera ricevitori	Barrière récepteur	透過形 受光器	Barrera receptor	
T30-SN6-R-Q							

SPECIFICATION	CHARAKTERISTIKEN	SPECIFICHE	CARACTÉRISTIQUES	仕様	CARACTERÍSTICAS
Supply Voltage	Betriebsspannung	Tensione di alimentazione	Tension d'alimentation	電源電圧	Tensión de alimentación
Load Current (max.)	Dauerstrom	Corrente a carico continuo	Courant de charge	負荷電流	Corriente de carga continua
Enclosure	Schutzart	Classe di protezione	Mode de protection	保護構造	Tipo de protección
Circuit Protection*	Schutzschaltungen*	Protezione*	Protection*	保護回路*	Protección*
Temperature Rating	Zul. Umgebungstemperatur	Temperature di funzionamento	Température ambiante admissible	使用周囲温度範囲	Intervalo de temperatura
*Reverse polarity (A)	*Verpolschutz (A)	*Inversione di polarità (A)	*Inversion de polarité (A)	*逆配 (A)	*Inversión de polaridad (A)
*Short-circuit (B)	*Kurzschlussschutz (B)	*Cortocircuito (B)	*Cours-circuits (B)	*短絡 (B)	*Cortocircuitos (B)
					10...30 VDC
					150 mA
					IP67
					A+B *
					-40 °C...+70 °C (-40 °F to +158 °F)

PACKING LIST	LIEFERUMFANG	PACKING LIST	LIVRAISON	同梱品リスト	ALBARAN
Sensor	Sensor	Sensore	Détecteur	センサ	Sensor
Data sheet	Datenblatt	Data sheet	Notice technique	データシート	Hoja de características
Screws M30, AF36	Montagemutter M30, SW36	Dado di fissaggio M30, CH36	Ecrous de montage M30, clé36	締付ナット M30×1	Tuerca de montaje M30, CH36



53000



WARNING

Not To Be Used for Personnel Protection
 Never use this device as a sensing device for personnel protection. Doing so could lead to serious injury or death. This device does not include the self-checking redundant circuitry necessary to allow its use in personnel safety applications. A sensor failure or malfunction can cause either an energized or de-energized sensor output condition.



WARNUNG

Darf nicht für den Personenschutz verwendet werden
 Dieses Gerät darf nicht als Sensor zum Personenschutz eingesetzt werden. Eine Nichtbeachtung kann schwere Verletzungen oder Tod zur Folge haben. Dieses Gerät verfügt nicht über die selbstüberwachenden redundanten Schaltungen, die für Personenschutz-Anwendungen erforderlich sind. Ein Sensorausfall oder Defekt kann zu unvorhersehbarem Schaltverhalten des Ausgangs führen.

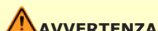

AVVERTENZA

Non usare per la protezione del personale
 Non usare questo dispositivo come dispositivo di rilevamento per la protezione del personale. Il mancato rispetto di questo requisito può comportare gravi lesioni fisiche o morte. Questo dispositivo non è dotato dei circuiti di autodiagnostica ridondanti necessari per permetterne l'uso in applicazioni di sicurezza del personale. Pertanto, guasti o cattivi funzionamenti del sensore possono provocare variazioni del segnale in uscita.



AVERTISSEMENT

A ne pas utiliser en guise de protection individuelle
 Ce produit ne doit pas être utilisé en tant que système de détection destiné à la protection individuelle. Une utilisation dans de telles conditions pourrait entraîner des dommages corporels graves, voire mortels. Ce produit n'est pas équipé du circuit redondant d'autodiagnostic nécessaire pour être utilisé dans des applications de protection personnelle. Une panne du capteur ou un mauvais fonctionnement peut entraîner l'activation ou la désactivation de la sortie.



警告

人身防護用に使用しないでください
 本製品を人身保護用の検出装置として使用しないでください。重大なけがや死亡事故に繋がる危険があります。本製品は、安全関連のアプリケーションに使用する上で最低限必要な二重化回路と自己診断機能を内蔵していません。本製品の故障または誤動作により、出力がONになる場合とOFFになる場合のどちらの場合もあります。



ADVERTENCIA

No se debe utilizar como protección personal
 No utilice nunca este dispositivo como dispositivo de detección con fines de protección personal. De ser así, podrían producirse lesiones graves o incluso la muerte. Este dispositivo no incluye los circuitos redundantes de autocontrol necesarios para permitir su uso en aplicaciones de seguridad personal. Un error de funcionamiento o un fallo del sensor pueden provocar una situación de salida del sensor con corriente o sin corriente.

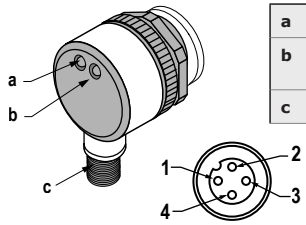

a	Green LED—power on	grüne LED - Betriebsspannung	LED verde - tensione di alimentazione	LED verte - tension de service	電源表示 (緑 : 過負荷時点滅)	LED indicador verde - alimentación
b	Amber LED—output indicator	gelbe LED - Ausgangsanzeige	LED giallo - indicazione dell'uscita	LED jaune - visualisation de la sortie	受光量表示 (黄)	LED indicador amarillo - indicador de la salida
c	Cable or Quick Disconnect (QD)	Kabel oder Conprox Steckverbinder	Cava o connettore Conprox	Câble ou connecteur Conprox	ケーブルまたはQDコネクタ	Cable o conector Conprox

	CONNECTIONS	ANSCHLUß	CONNESSIONE	RACCORDEMENT	配線	CONEXIONES
1 (BN)	Brown	braun	marrone	brun	茶	marrón
2 (WH)	White	weiß	bianco	blanc	白	blanco
3 (BU)	Blue	blau	blu	bleu	青	azul
4 (BK)	Black	schwarz	nero	noir	黒	negro
*LOAD	Load	Last	Carico	Charge	負荷	Carga
†Alarm	Alarm	Alarm	Allarme	Alarme	アラーム	Alarma

T30-SP6-...

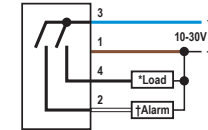
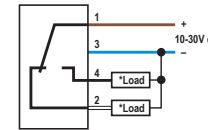

T30-6-... Emitter Only 投光器側配線

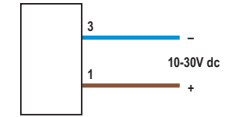

T30-SN6-...

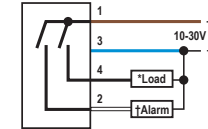
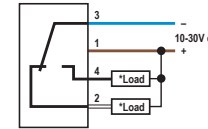

ALIGNMENT JUSTAGE ALLINEAMENTO REGLAGE 光軸調整 ALINEACION

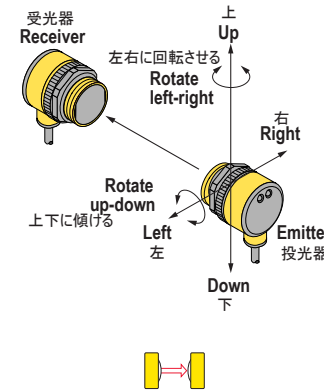
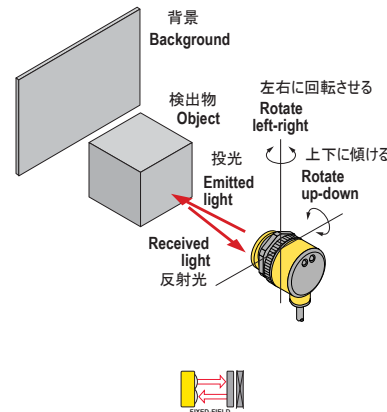
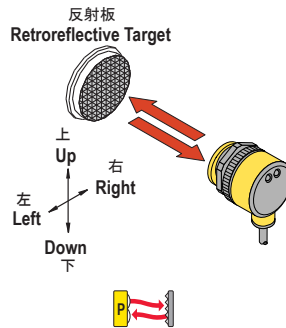

Banner Engineering Corp. Limited Warranty

Banner Engineering Corp. warrants its products to be free from defects in material and workmanship for one year following the date of shipment. Banner Engineering Corp. will repair or replace, free of charge, any product of its manufacture which, at the time it is returned to the factory, is found to have been defective during the warranty period. This warranty does not cover damage or liability for misuse, abuse, or the improper application or installation of the Banner product.

THIS LIMITED WARRANTY IS EXCLUSIVE AND IN LIEU OF ALL OTHER WARRANTIES WHETHER EXPRESS OR IMPLIED (INCLUDING, WITHOUT LIMITATION, ANY WARRANTY OF MERCHANTABILITY OR FITNESS FOR A PARTICULAR PURPOSE), AND WHETHER ARISING UNDER COURSE OF PERFORMANCE, COURSE OF DEALING OR TRADE USAGE.

This Warranty is exclusive and limited to repair or, at the discretion of Banner Engineering Corp., replacement. IN NO EVENT SHALL BANNER ENGINEERING CORP. BE LIABLE TO BUYER OR ANY OTHER PERSON OR ENTITY FOR ANY EXTRA COSTS, EXPENSES, LOSSES, LOSS OF PROFITS, OR ANY INCIDENTAL, CONSEQUENTIAL OR SPECIAL DAMAGES RESULTING FROM ANY PRODUCT DEFECT OR FROM THE USE OR INABILITY TO USE THE PRODUCT, WHETHER ARISING IN CONTRACT OR WARRANTY, STATUTE, TORT, STRICT LIABILITY, NEGLIGENCE, OR OTHERWISE.

Banner Engineering Corp. reserves the right to change, modify or improve the design of the product without assuming any obligations or liabilities relating to any product previously manufactured by Banner Engineering Corp. Any misuse, abuse, or improper application or installation of this product or use of the product for personal protection applications when the product is identified as not intended for such purposes will void the product warranty. Any modifications to this product without prior express approval by Banner Engineering Corp will void the product warranties. All specifications published in this document are subject to change; Banner reserves the right to modify product specifications or update documentation at any time. Specifications and product information in English supersede that which is provided in any other language. For the most recent version of any documentation, refer to: www.bannerengineering.com.

For patent information, see www.bannerengineering.com/patents.