

# QMT42 Series 400 mm Adjustable Field Sensors



## Datasheet

Sensing cutoff point is adjustable from 125 mm to 400 mm (5 in to 16 in)



- Adjustable field technology allows direct detection of objects within a defined sensing field, while completely ignoring reflective objects located beyond the sensing field cutoff point
- Reliable electronic adjustment<sup>1</sup> of sensing field cutoff point from 125 mm to 400 mm; no mechanical adjustments to worry about
- Low-cost, compact, rugged sensors in metal die-cast housings
- Epoxy-encapsulated circuitry; leakproof IP67 (NEMA 6) construction for reliable sensing in harsh environments
- Outstanding electrical noise immunity
- Dual LED system indicates sensor performance
- Choice of integral cable or quick disconnect connector



### WARNING: Not To Be Used for Personnel Protection

Never use this device as a sensing device for personnel protection. Doing so could lead to serious injury or death. This device does not include the self-checking redundant circuitry necessary to allow its use in personnel safety applications. A sensor failure or malfunction can cause either an energized or de-energized sensor output condition.

## Models

Models	Range	Cutoff Point	Cable	Supply Voltage	Output Type
QMT42VN6AFV400	25 mm (1 in) to Cutoff point	125 mm to 400 mm (5 in to 16 in)	2 m (6.5 ft)	10 V dc to 30 V dc	NPN
QMT42VN6AFV400Q			4-pin Euro QD		
QMT42VP6AFV400			2 m (6.5 ft)		PNP
QMT42VP6AFV400Q			4-pin Euro QD		

## Adjustable Field Sensing – Theory of Operation

The receiver element of an adjustable field sensor produces two currents: I1 and I2. The ratio of these two currents changes as the received light signal moves along the length of the receiver element. See [Figure 1](#) on page 2. The sensing cutoff distance relates directly to this ratio, which can be adjusted using the sensor's multi-turn potentiometer.

The cutoff distance for model QMT...AF... sensors is adjustable from 125 to 400 millimeters (5 to 16 inches) Objects lying beyond the cutoff distance are usually ignored, even if they are highly reflective. However, under certain conditions, it is possible to falsely detect a background object (see [Placement](#) on page 2).

As a general rule, the most reliable sensing of an object which approaches from the side occurs when the line of approach is parallel to the sensing axis.

<sup>1</sup> Patent Pending



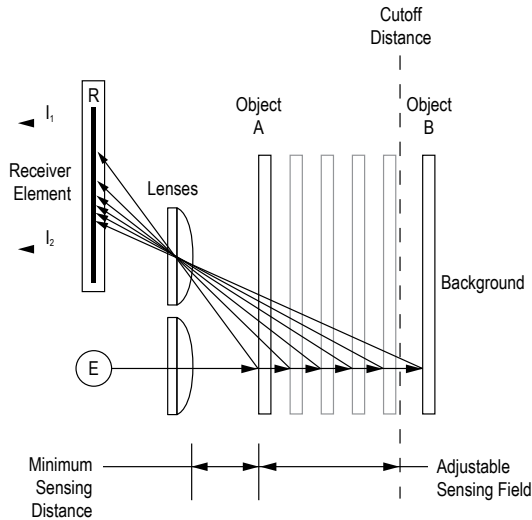

Figure 1. Adjustable Field Sensing Concept

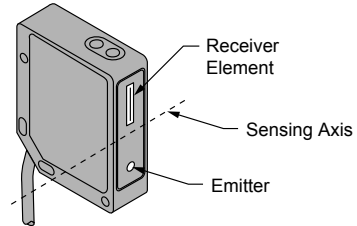
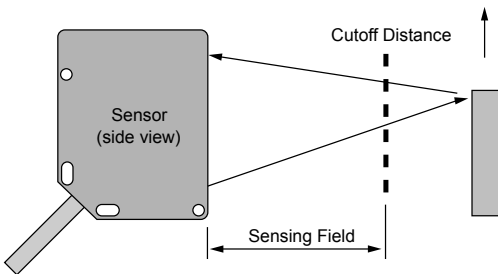

Figure 2. Fixed-Field Sensing Axis

## Placement

An object beyond the cutoff distance, either stationary (and when positioned as shown in [Figure 3](#) on page 2), or moving past the face of the sensor in a direction perpendicular to the sensing axis, may cause unwanted triggering of the sensor if more light is reflected to the near detector than to the far detector. Correct the problem by rotating the sensor 90° ([Figure 4](#) on page 2). The object then reflects the R1 and R2 fields equally, resulting in no false triggering. A better solution, if possible, may be to reposition the object or the sensor.



A reflective background object in this position or moving across the sensor face in this axis and direction may cause a false sensor response.

Figure 3. Object Beyond Cutoff - Problem

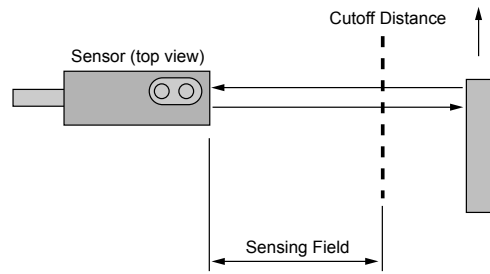

A reflective background object in this position or moving across the sensor face in this axis is ignored.

Figure 4. Object Beyond Cutoff - Solution

## Specifications

### Sensing Beam

Visible red, 680 nm

### Supply Voltage and Current

10 V dc to 30 V dc (10% maximum ripple) at less than 50 mA

### Supply Protection Circuitry

Protected against reverse polarity and transient voltages

### Output Configuration

SPDT (complementary) solid-state dc switch; Choose NPN or PNP models  
 Light operate: N.O. output conducts when the sensor sees its own (or the emitter's) modulated light  
 Dark operate: N.C. output conducts when the sensor sees dark

### Output Configuration

SPDT (complementary) solid-state dc switch; choose NPN or PNP models  
 Light operate: N.O. output conducts when the sensor sees its own modulated light  
 Dark operate: N.C. output conducts when the sensor sees dark

### Output Rating

100 mA maximum (each output)  
 OFF-state leakage current: < 5 microamps at 30 V dc  
 ON-state saturation voltage: < 1 V at 10 mA dc; < 1.5 V at 100 mA dc

### Output Protection Circuitry

Protected against false pulse on power-up and continuous overload or short-circuit of outputs  
 Overload trip point  $\geq$  150 mA, typical, at 20 °C

### Output Response Time

1 millisecond on and off



**Note:** 100 millisecond delay on power-up; outputs are non-conducting during this time

### Repeatability of Response

250 microseconds

### Sensing Hysteresis

Less than 7% of set cutoff distance

### Adjustments

All models have a 15-turn slotted brass cutoff distance adjustment potentiometer (clutched at both ends of travel)

### Indicators

Two LEDs: Green and Amber  
 Green on steady = power to sensor is ON  
 Green flashing = output is overloaded  
 Amber on steady = light is sensed; normally open output ON  
 Amber flashing = marginal excess gain (1-1.5x) in light condition

### Construction

Housings are die-cast zinc alloy with black acrylic polyurethane finish; lenses are acrylic

### Environmental Rating

IEC IP67/NEMA 6

### Connections

2 m (6.5 ft) or 9 m (30 ft) attached cable, or 4-pin M12/Euro-style quick-disconnect fitting; cables for QD models are purchased separately

### Operating Conditions

Operating Temperature: -20 °C to +55 °C (-4 °F to +131°F)  
 90% at +50 °C maximum relative humidity (non-condensing)

### Required Overcurrent Protection



**WARNING:** Electrical connections must be made by qualified personnel in accordance with local and national electrical codes and regulations.

Overcurrent protection is required to be provided by end product application per the supplied table.  
 Overcurrent protection may be provided with external fusing or via Current Limiting, Class 2 Power Supply.  
 Supply wiring leads < 24 AWG shall not be spliced.  
 For additional product support, go to <http://www.bannerengineering.com>.

Supply Wiring	Required Overcurrent Protection
20	5.0 Amps
22	3.0 Amps
24	2.0 Amps
26	1.0 Amps
28	0.8 Amps
30	0.5 Amps

### Certifications



## Cutoff Point Deviation

The percentage of deviation indicates a change in the cutoff point for either 18% gray or 6% black targets, relative to the cutoff point for a 90% reflective white test card. As an example, the cutoff point decreases 10% for a 6% reflectance black target when the cutoff point is 400 millimeters (16 inches) using a 90% reflectance white test card. In other words, the cutoff point for the black target is 360 millimeters (14 inches).

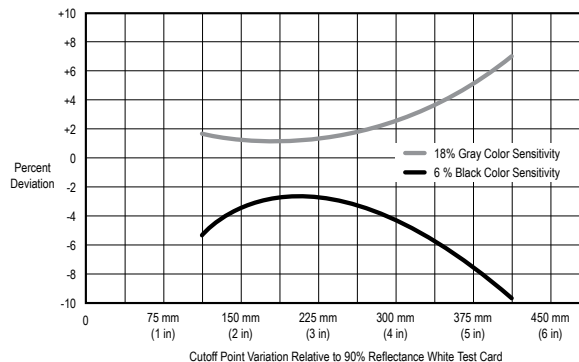

## Dimensions

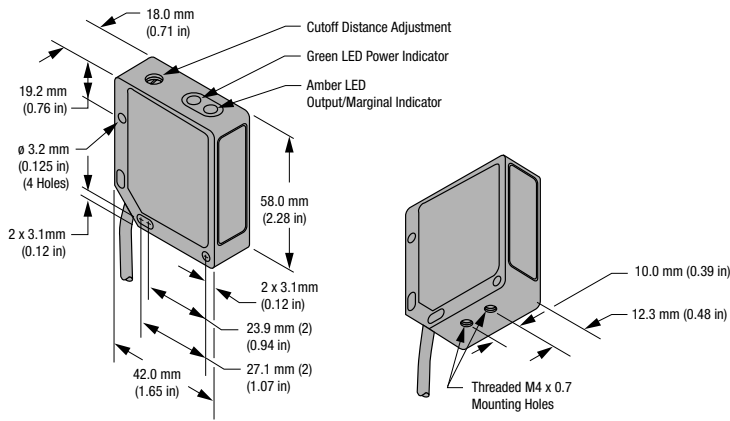

Figure 5. Cabled Models

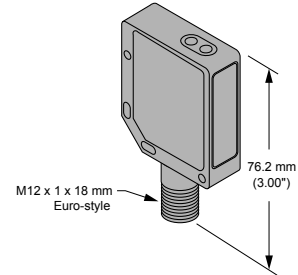

Figure 6. Quick-Disconnect Models

All measurements are listed in millimeters (inches), unless noted otherwise.

## Wiring

Sensors with NPN Outputs		Sensors with PNP Outputs	
Cabled Models	Quick-Disconnect Models	Cabled Models	Quick-Disconnect Models

## Accessories

### Quick-Disconnect (QD) Cables

4-Pin Threaded M12/Euro-Style Cordsets				
Model	Length	Style	Dimensions	Pinout (Female)
MQDC-406	1.83 m (6 ft)	Straight		<p>1 = Brown 2 = White 3 = Blue 4 = Black</p>
MQDC-415	4.57 m (15 ft)			
MQDC-430	9.14 m (30 ft)			
MQDC-450	15.2 m (50 ft)			
MQDC-406RA	1.83 m (6 ft)	Right-Angle		
MQDC-415RA	4.57 m (15 ft)			
MQDC-430RA	9.14 m (30 ft)			
MQDC-450RA	15.2 m (50 ft)			

## Mounting Brackets

### SMB19

- Right-angle mounting bracket with a curved slot for versatile orientation

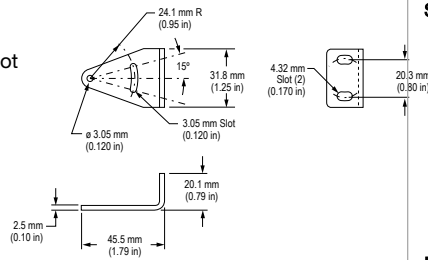

### SMB42F

- 13-ga. stainless steel
- Hardware included

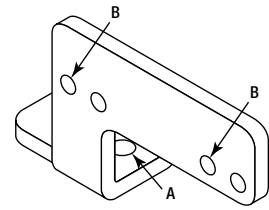

**Hole center spacing:** A = 10.0, B = 25.4

**Hole size:** A =  $\varnothing$  3.4, B =  $\varnothing$  2.5

### SMB42L

- 13-ga. stainless steel
- Hardware included

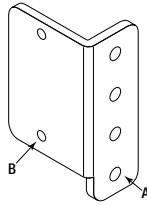

**Hole center spacing:** A = 10.0, B = 25.4

**Hole size:** A =  $\varnothing$  3.4, B =  $\varnothing$  2.5

### SMB42U

- 13-ga. stainless steel
- Hardware included

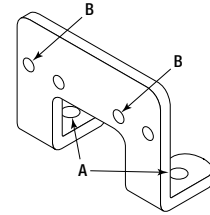

**Hole center spacing:** A = 30.0, B = 25.4

**Hole size:** A =  $\varnothing$  3.4, B =  $\varnothing$  2.5

## Banner Engineering Corp. Limited Warranty

Banner Engineering Corp. warrants its products to be free from defects in material and workmanship for one year following the date of shipment. Banner Engineering Corp. will repair or replace, free of charge, any product of its manufacture which, at the time it is returned to the factory, is found to have been defective during the warranty period. This warranty does not cover damage or liability for misuse, abuse, or the improper application or installation of the Banner product.

**THIS LIMITED WARRANTY IS EXCLUSIVE AND IN LIEU OF ALL OTHER WARRANTIES WHETHER EXPRESS OR IMPLIED (INCLUDING, WITHOUT LIMITATION, ANY WARRANTY OF MERCHANTABILITY OR FITNESS FOR A PARTICULAR PURPOSE), AND WHETHER ARISING UNDER COURSE OF PERFORMANCE, COURSE OF DEALING OR TRADE USAGE.**

This Warranty is exclusive and limited to repair or, at the discretion of Banner Engineering Corp., replacement. **IN NO EVENT SHALL BANNER ENGINEERING CORP. BE LIABLE TO BUYER OR ANY OTHER PERSON OR ENTITY FOR ANY EXTRA COSTS, EXPENSES, LOSSES, LOSS OF PROFITS, OR ANY INCIDENTAL, CONSEQUENTIAL OR SPECIAL DAMAGES RESULTING FROM ANY PRODUCT DEFECT OR FROM THE USE OR INABILITY TO USE THE PRODUCT, WHETHER ARISING IN CONTRACT OR WARRANTY, STATUTE, TORT, STRICT LIABILITY, NEGLIGENCE, OR OTHERWISE.**

Banner Engineering Corp. reserves the right to change, modify or improve the design of the product without assuming any obligations or liabilities relating to any product previously manufactured by Banner Engineering Corp. Any misuse, abuse, or improper application or installation of this product or use of the product for personal protection applications when the product is identified as not intended for such purposes will void the product warranty. Any modifications to this product without prior express approval by Banner Engineering Corp will void the product warranties. All specifications published in this document are subject to change; Banner reserves the right to modify product specifications or update documentation at any time. Specifications and product information in English supersede that which is provided in any other language. For the most recent version of any documentation, refer to: [www.bannerengineering.com](http://www.bannerengineering.com).