

# Q90R2 R-GAGE® Radar Sensor Product Manual



Original Instructions

p/n: 240867 Rev. B

03-Oct-24

© Banner Engineering Corp. All rights reserved.

# Contents

## Chapter 1 Product Description

Models .....	4
Overview .....	5
Features and Indicators .....	6
Banner Measurement Sensor Software .....	6

## Chapter 2 Installation Instructions

Sensor Orientation .....	7
Wiring .....	7
Mount the Device .....	8

## Chapter 3 Getting Started

Install the Software .....	9
Connect to the Sensor .....	9
Software Overview .....	10

## Chapter 4 Banner Measurement Sensor Workspace

Navigation Toolbar .....	11
Live Sensor Data .....	11
2D Scatter Tab .....	11
Spectrum Tab .....	12
Summary Pane .....	13
Sensor Settings Pane .....	13
General Tab .....	13
Discrete 1 Tab .....	14
Discrete 2 Tab .....	14
Analog Tab .....	15
Live Sensor Data Controls .....	16
Using Measurement Hold Example .....	17

## Chapter 5 Configuring a Sensor

Banner Measurement Sensor Software .....	18
IO-Link Interface .....	18
Remote Input .....	18
Remote Teach .....	20
Remote Setup .....	20
Set the Signal Strength Threshold .....	21
Set the Speed .....	22
Target Selection Mode .....	22
Set the Shape of the Detection Area .....	23
Reset the Sensor to Factory Defaults .....	23
Factory Default Settings .....	24

## Chapter 6 Specifications

FCC Part 15 Class A for Intentional Radiators .....	26
Industry Canada Statement for Intentional Radiators .....	27
ISED Compliance Aircraft Warning .....	27
Dimensions .....	27
Beam Patterns .....	28

## Chapter 7 Accessories

Configuration Tool .....	29
Cordsets .....	29
Brackets .....	30
IO-Link Masters .....	31

## Chapter 8 Product Support

Update the Software .....	32
Supporting Documentation .....	33
Repairs .....	33
Contact Us .....	33

Banner Engineering Corp. Software Copyright Notice .....	33
Banner Engineering Corp Limited Warranty .....	33

Chapter Contents

Models ..... 4  
 Overview ..... 5  
 Features and Indicators ..... 6  
 Banner Measurement Sensor Software ..... 6

# Chapter 1 Product Description

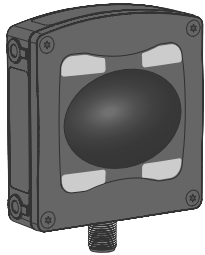

- FMCW radar detects moving and stationary objects
- Adjustable sensing field—ignores objects beyond setpoint
- Easy setup and configuration using the Banner Measurement Sensor Software
- Sensing functions are immune to wind, fog, steam, and temperature changes and resistant to rain and snow
- Compact, rugged IP69K housing withstands harsh environments
- Highly configurable field of view enables precision positioning and control
- Reliable detection across a broad vertical and horizontal field of view
- Customize advanced parameters such as window shape and target setpoints to each application

**WARNING:**



- **Do not use this device for personnel protection**
- Using this device for personnel protection could result in serious injury or death.
- This device does not include the self-checking redundant circuitry necessary to allow its use in personnel safety applications. A device failure or malfunction can cause either an energized (on) or de-energized (off) output condition.

**WARNING:**



- **N'utilisez pas ce dispositif pour la protection du personnel.**
- L'utilisation de ce dispositif pour la protection du personnel pourrait entraîner des blessures graves ou mortelles.
- Ce dispositif n'est pas équipé du circuit redondant d'autodiagnostic nécessaire pour être utilisé dans des applications de protection du personnel. Une panne ou un dysfonctionnement du dispositif peut entraîner l'activation ou la désactivation de la sortie.

**IMPORTANT:** To satisfy RF exposure requirements, this device and its antenna must operate with a separation distance of at least 20 cm (7.9 in) from all persons.

## Models

60 GHz Models

Models	Detection Range	Supply Voltage	Telecom Approved	Output
Q90R2-12040-6KDQ	0.15 m to 20 m (0.5 ft to 65.6 ft)	10 V DC to 30 V DC	US, Canada, Europe, Australia, New Zealand	Dual discrete (NPN/PNP, PFM, and IO-Link)
Q90R2-12040-6KIQ				Analog current (4 mA to 20 mA, 1 NPN/PNP discrete, and IO-Link)

Continued on page 5

Continued from page 4

Models	Detection Range	Supply Voltage	Telecom Approved	Output
Q90R2-12040-6KUQ		12 V DC to 30 V DC		Analog voltage (0 V to 10 V or 0.5 V to 4.5 V, 1 NPN/ PNP discrete, and IO-Link)

## Overview

The Q90R2 is an industrial radar sensor that uses high-frequency radio waves from its internal antenna to detect and measure distance to objects in its field of view.

The Q90R2 detects a wide variety of materials including metal, liquids, or organic materials. Use the supplied software, IO-Link, or a remote input wire to configure the sensor to sense objects within a specified distance or area while ignoring objects beyond this distance or area (background suppression). Or configure the sensor to indicate the presence or absence of objects at a specific (or "taught") distance or range of distances (retroreflective).

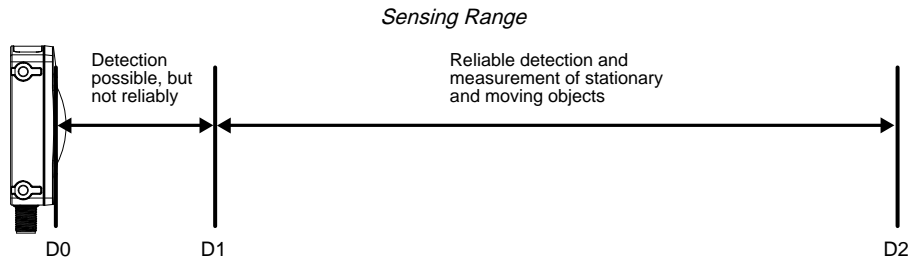

D0 (m)	D1 (m)	D2 (m)
0	0.15	20

*Sensing Field of View: 120 degrees × 40 degrees*

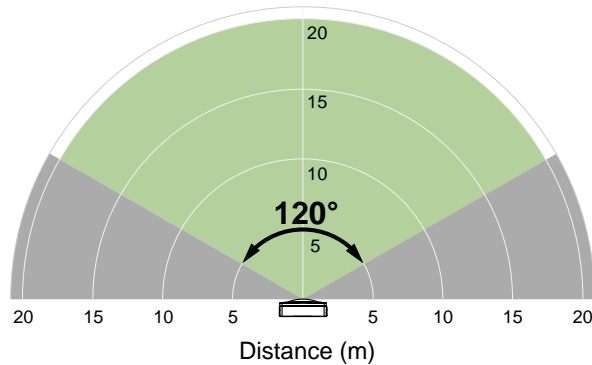

See "[Beam Patterns](#)" on page 28 for details.

## Features and Indicators

		LED	Color	Description
	1	Power	Green	Power ON
	2	Signal Strength	Green	Signal strength indication
	3	Output 1	Amber	Target is within the taught analog span or discrete output status
	4	Output 2	Amber	Discrete output status

## Banner Measurement Sensor Software



Use the Banner Measurement Sensor software to:

- Quickly configure the sensor
- Easily monitor device status via the software
- Visualize the application in real-time
- Make adjustments to sensor settings on the fly

For more information, visit [www.bannerengineering.com/us/en/products/sensors/software/banner-measurement-sensor-software.html](http://www.bannerengineering.com/us/en/products/sensors/software/banner-measurement-sensor-software.html).

Chapter Contents  
 Sensor Orientation ..... 7  
 Wiring ..... 7  
 Mount the Device ..... 8

# Chapter 2 Installation Instructions

## Sensor Orientation

Correct sensor-to-object orientation is important to ensure proper sensing.

Minimize the tilt angle of a target relative to the sensor. The target should be tilted less than half of the beam angle.

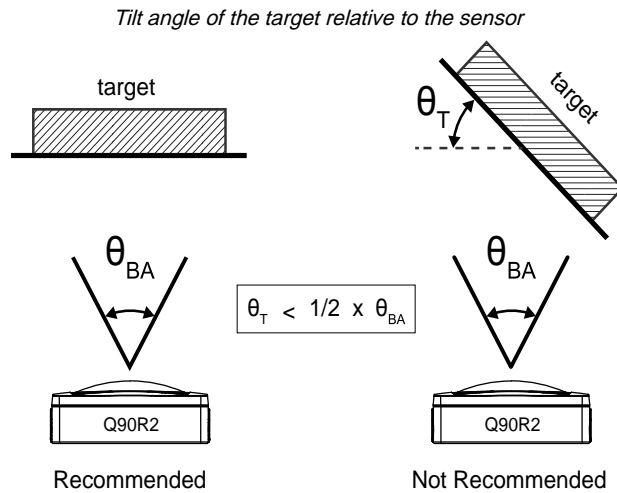

T= Target Angle, BA=Beam Angle

## Wiring

Quick disconnect wiring diagrams are functionally identical.

*Push-pull Output and Analog Current Output*

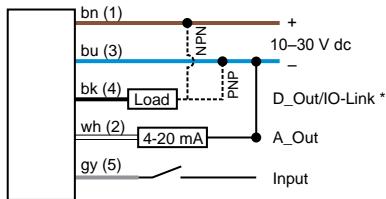

\* Push-Pull output. User-configurable PNP/NPN setting.

*Push-pull Output and Analog Voltage Output*

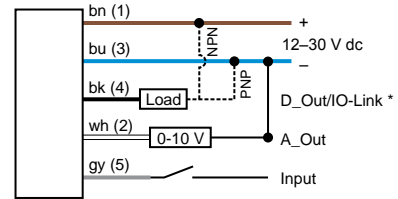

\* Push-Pull output. User-configurable PNP/NPN setting.

Continued on page 8

Continued from page 7

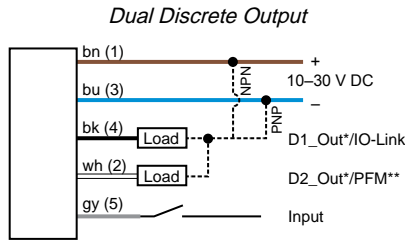

\* Push-Pull output. User-configurable PNP/NPN setting.  
 \*\* Pulse Frequency Modulation

**Key:**

- 1 = Brown
- 2 = White
- 3 = Blue
- 4 = Black
- 5 = Gray (Connect for use with remote input or Banner Measurement Sensor software)

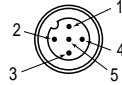

**NOTE:** Banner recommends that the shield wire (quick-disconnect cordsets only) be connected to earth ground or DC common. Shielded cordsets are recommended for all quick-disconnect models.

## Mount the Device

1. If a bracket is needed, mount the device onto the bracket.
2. Mount the device (or the device and the bracket) to the machine or equipment at the desired location. Do not tighten the mounting screws at this time.
3. Check the device alignment.
4. Tighten the mounting screws to secure the device (or the device and the bracket) in the aligned position.



Chapter Contents

Install the Software..... 9  
 Connect to the Sensor..... 9  
 Software Overview ..... 10

# Chapter 3 Getting Started

Power up the sensor, and verify the green power LED is on.

## Install the Software

**IMPORTANT:** Administrative rights are required to install the Banner Measurement Sensor software.

1. Download the latest version of the software from [www.bannerengineering.com/us/en/products/sensors/software/banner-measurement-sensor-software.html](http://www.bannerengineering.com/us/en/products/sensors/software/banner-measurement-sensor-software.html).
2. Navigate to and open the downloaded file.
3. Click **Install** to begin the installation process.
4. Depending on your system settings, a popup window may appear prompting to allow the Banner Measurement Sensor software to make changes to your computer. Click **Yes**.
5. Click **Close** to exit the installer.

## Connect to the Sensor

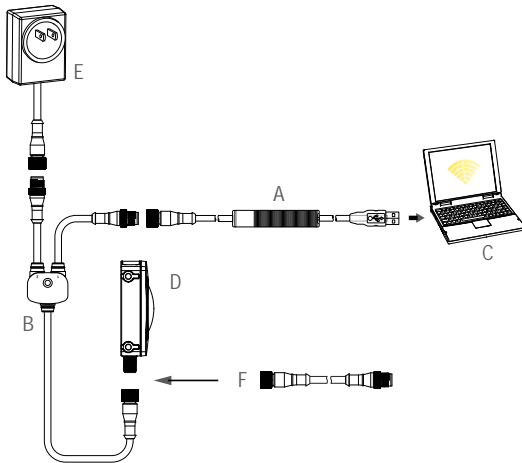

- A = Pro Converter Cable (MQDC-506-USB)
- B = Splitter (CSB-M1251FM1251M)
- C = PC running Banner Measurement Sensor software
- D = Q90R2
- E = Power Supply (PSW-24-1 or PSD-24-4)
- F = Optional 5-Pin to 5-Pin Double-Ended Cordset (ex. MQDEC3-515SS)

1. Connect the sensor to the splitter cable from the PRO-KIT. See "[Configuration Tool](#)" on page 29.
2. Connect the external power and Pro Converter cable to the splitter cable.
3. Connect the Pro Converter cable to the PC.
4. Open the Banner Measurement Sensor Software.
5. Go to **Sensor > Connect** on the **Navigation** toolbar.  
The **Connection** screen displays.
6. Select the correct **Sensor Model** and **Com Port** for the sensor.
7. Click **Connect**.  
The **Connection** screen closes and the sensor data displays.

# Software Overview

Easy setup and configuration using the Banner Measurement Sensor software and Pro Converter Cable.

*Banner Measurement Sensor Software*

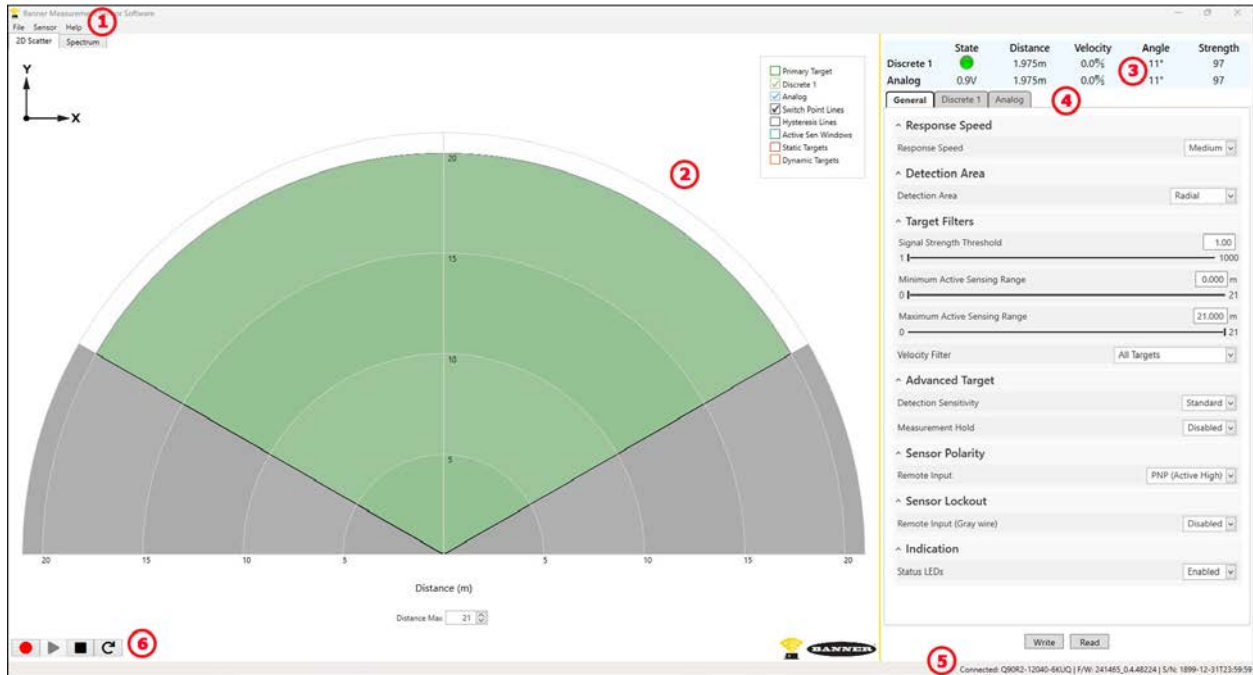

1. Navigation toolbar—Use this toolbar to connect to the sensor, to save or load a configuration, or to reset to factory defaults
2. Live Sensor Data—
  - 2D Scatter tab: Shows the location of targets detected within the active sensing range, as well as options to select which data displays on the 2D Scatter tab
  - Spectrum tab: Shows the signal strength versus distance for the connected sensor (not shown)
3. Summary pane—Displays the distance to the target, the velocity, the angle, the signal strength, and the output status
4. Sensor Settings pane—Set the sensor parameters in this pane
5. Status bar—Shows whether the sensor is connected, if a software update is available, and if the sensor data is being recorded to a file
6. Live Sensor Data controls—Use these controls to record, freeze, and play real-time sensor data, and to refresh the sensor connection

Chapter Contents

Navigation Toolbar.....	11
Live Sensor Data.....	11
Summary Pane.....	13
Sensor Settings Pane.....	13
Live Sensor Data Controls .....	16
Using Measurement Hold Example.....	17

# Chapter 4      Banner Measurement Sensor Workspace

---

## Navigation Toolbar

Use this toolbar to connect to the sensor, to save or load a configuration, or to reset to factory defaults.

**From the File menu, the following options are available:**

**Load Configuration**

Load a configuration to the connected sensor. Use this option to set up multiple sensors with the same parameters.

**Save Configuration**

Save a configuration to a desired location for future use.

**Reset Frequently Used Settings**

Resets the software settings without changing the configuration of the attached sensor.

**Exit**

Exit the Banner Measurement Sensor software.

**From the Sensor menu, the following options are available:**

**Connect**

Connect to the sensor.

**Disconnect**

Disconnect from the sensor.

**Factory Reset**

Select to perform a factory reset on the sensor. All custom parameters will be lost

**From the Help menu, the following option is available:**

**About**

Select to view the software version number, the copyright notice, and the warranty.

## Live Sensor Data

### 2D Scatter Tab

The **2D Scatter** tab displays the live target information within the horizontal active sensing area. This includes the primary target, static targets, and dynamic targets.

The discrete detection areas are visualized. Adjust them by clicking and dragging on the switch point lines of the detection area. The active sensing range correspond to the color of each output window and are hidden by default.

Use **Distance Max** to adjust the range and field of view displayed on the **2D Scatter** tab.

**Legend** -- Use the legend to select which data appears on the graph:

**Primary Target**

Represents the location of the target inside the switch point window.

**Discrete 1/Discrete 2**

The defined area for which the output state changes when a target is detected.

**Analog**

The range the analog signal represents.

Available on analog models.

Varies by output model.

**Switch Point Lines**

Displays the switch point extents.

**Hysteresis Lines**

Displays the hysteresis. If a range-angle window is configured, the hysteresis is defined and displayed corresponding to the beam angle. If a rectangular window is defined, the hysteresis is defined and displayed corresponding to the X and Y dimension.

**Active Sen Windows**

Defines the area in which the sensor is actively detecting and evaluating targets. It is based on the output window and threshold that have been defined.

**Static Targets**

Targets within the Active Sensing Range with no velocity.

**Dynamic Targets**

Targets within the Active Sensing Range with velocity toward or away from the origin (the sensor).

## Spectrum Tab

The **Spectrum** tab displays the live distance and amplitude signal from the connected radar sensor. The signal strength threshold, switch point, and hysteresis are also plotted. Use these signals to evaluate targets to determine where the signal strength threshold and switch point should be configured for reliable detection.

Use the **Y-Axis Max** and the **X-Axis Max** to adjust the range displayed on the plot.

**Legend** -- Use the legend to select which data appears on the graph.

**Signal**

Displays the strength of the signal over distance.

**Signal Threshold**

Displays the signal strength threshold.

**Primary Target**

Represents the signal strength and location of the nearest or strongest target inside the switch point.

**Discrete 1 Window/Discrete 2 Window**

The range for the discrete output.

Varies by output model.

**Analog 1 Window**

The range of the analog output Varies by output model.

**Switch Point Lines**

Displays the switch point distance.

**Hysteresis Lines**

Displays the hysteresis distance.

## Summary Pane

The **Summary** pane (blue shaded area) displays **Distance**, **Velocity**, **Angle**, **Signal Strength**, and **Output Status**.

### State

Displays whether the output is ON or OFF, and the analog output value (analog models only).

### Distance

Displays the distance to the target, in meters.

### Velocity

Displays the velocity of the target relative to the sensor, in meters per second.

### Angle

Displays the angle of the target relative to the sensor, in degrees.

### Strength

Displays the amount of excess gain of the signal received from the target. The excess gain is relative to the minimum detection threshold (Signal Strength Threshold = 1).

## Sensor Settings Pane

Set parameters for the sensor.

Click **Read** to read the current parameters of the connected sensor. Click **Write** to write the parameters to the sensor. Yellow highlight on a parameter's value indicates changes that have not yet been written to the sensor.

### General Tab

The following are the parameters on the **General** tab on the **Sensor Settings** pane.

#### Response Speed

Choose the response speed of the sensor (Slow, Medium, Fast).

#### Detection Area

Set the shape of the detection area. Choose **Radial** or **Rectangular**.

#### Target Filters

**Signal Strength Threshold:** Choose the threshold for the minimum amount of signal needed to activate the output.

**Minimum Active Sensing Range:** Sensor ignores anything from the face of the sensor to this defined range.

**Maximum Active Sensing Range:** Sensor ignores anything past this defined range.

**Velocity Filter**—Allows further thresholds to be defined based on the velocity of targets and their direction of movement relative to the sensor:

**All Targets**—Targets with any velocity (or no velocity) are detected within the defined detection area.

**Dynamic Targets Only**—Only targets with a component of velocity in the radial direction, either towards or away from the sensor, are detected.

**Approaching Targets Only**—Only targets moving toward the sensor (targets with a negative velocity) are detected with the defined detection area.

**Receding Targets Only**—Only targets moving away from the sensor (targets with a positive velocity) are detected with the defined detection area.

**Custom**—Allows the user to define a custom threshold based on velocity switch points.

## Advanced Target

### Detection Sensitivity:

**Standard**—Balanced thresholds for accurate detection of targets and prevention of false detection.

**High**—Reduced thresholds for higher likelihood of target detection, especially for targets with a low signal strength.

**Measurement Hold:** A rate of change filter to smooth the output and reduce chatter. For more information, see ["Using Measurement Hold Example" on page 17](#).

**Distance Increase Hold Time:** The period of time the sensor holds its last measurement and output status if the measurement changes more than the configured max distance increase. Available when **Measurement Hold** is set to enabled.

**Maximum Distance Increase:** The allowed limit the measurement can increase, or move farther away from the sensor, before initiating the **Measurement Hold**. Setting this to zero disables it. Available when **Measurement Hold** is set to enabled.

**Distance Decrease Hold Time:** The period of time the sensor holds its last measurement and output status if the measurement changes more than the configured max distance decrease. Available when **Measurement Hold** is set to enabled.

**Maximum Distance Decrease:** The allowed limit the measurement can decrease, or move closer to the sensor, before initiating the **Measurement Hold**. Setting this to zero disables it. Available when **Measurement Hold** is set to enabled.

### Sensor Polarity

Define the output and remote input signal type.

### Sensor Lockout

**Remote Input (Gray Wire):** Enable or disable the remote input wire.

### Indication

Enable or disable the **Status LEDs** on the sensor.

## Discrete 1 Tab

The following are the parameters on the **Discrete 1** tab on the **Sensor Settings** pane.

### Output Mode

Select **Switch Point** or **Window**.

**Switch Point:** The distance at which the switch point threshold is placed.

**Window:** Define two distance set points to create window limits.

### Detection Area Settings

**Target Mode:** Select **Nearest Target** or **Strongest Target**.

**Nearest Target:** Output responds to the nearest target that is over the signal strength threshold.

**Strongest Target:** Output responds to the target with the highest signal strength that is over the signal strength threshold.

**Switch Points:** Define the area in which the target will be detected and measured. Switch points are defined according to the detection area (Radial or Rectangular).

### Output Settings

**NO/NC:** Select **Normally Open** or **Normally Closed** from the list.

**On Delay:** Set an on delay in milliseconds. The maximum time is 60,000 ms.

**Off Delay:** Set an off delay in milliseconds. The maximum time is 60,000 ms.

### Response Time

Shows the On and Off response times. This information is view only.

## Discrete 2 Tab

The following are the parameters on the **Discrete 2** tab on the **Sensor Settings** pane. This tab is available for dual discrete models.

### Output Mode

Select **Switch Point**, **Window**, **Complementary**, or **Pulse Pro/PFM**.

**Switch Point:** Set a single switch point for the output to change.

**Window:** Define two setpoints to create window limits.

**Complementary:** Output 2 will be the opposite of Output 1.

**Pulse Pro/PFM:** Pulse Pro/PFM output to interface with Banner lights or a PLC with Pulse Frequency Modulated (PFM) inputs.

## Detection Area Settings

**Target Mode:** Select **Nearest Target** or **Strongest Target**.

**Nearest Target:** Output responds to the nearest target that is over the signal strength threshold.

**Strongest Target:** Output responds to the target with the highest signal strength that is over the signal strength threshold.

**Min/Max:** Define the area in which the target velocity will be measured. Available when Pulse Pro/PFM Settings is set to **Velocity**.

**Velocity Switch Points:** Define the minimum and maximum velocities which will correspond to the PFM minimum and maximum. Available when Pulse Pro/PFM Settings is set to **Velocity**.

## Output Settings

Available when Output Mode is set to **Switch Point** or **Window**.

**NO/NC:** Select **Normally Open** or **Normally Closed** from the list.

**On Delay:** Set an on delay in milliseconds. The maximum time is 60,000 ms.

**Off Delay:** Set an off delay in milliseconds. The maximum time is 60,000 ms.

## Response Time

Calculates the total response time, taking into account the general response speed and on or off delays.

## Pulse Pro/PFM Settings

Available when Output Mode is set to **Pulse Pro/PFM**.

The Q90R2 can generate pulses whose frequency are proportional to the sensor's measured distance or velocity, thereby providing a method for representing an analog signal with only a discrete counter. The sensing range or velocity range (defined in Detection Area Settings) of the sensor is scaled from 100 Hz to 600 Hz. 100 Hz equals the near range limit, and 600 Hz equals the far range limit. An output of 50 Hz or 650 Hz (user defined in the software) represents a loss of signal condition where there is no target or the target is out of range. This output can be tied directly to a number of Banner lights for visual feedback without the need for a controller.

**100 Hz:** Define the near sensing range limit of the Pulse Pro range.

**600 Hz:** Define the far sensing range limit of the Pulse Pro range.

**Loss-of-Signal:** Sets the value used by the sensor during a loss of signal. When a signal is restored, measurement resumes.

Hold last value—The Discrete 2 Output holds the last value indefinitely during a loss of signal.

50 Hz—The Discrete 2 Output switches to this value 2 seconds after a loss of signal.

650 Hz—The Discrete 2 Output switches to this value 2 seconds after a loss of signal.

## Analog Tab

The following are the parameters on the **Analog** tab on the **Sensor Settings** pane. This tab is available for analog models.

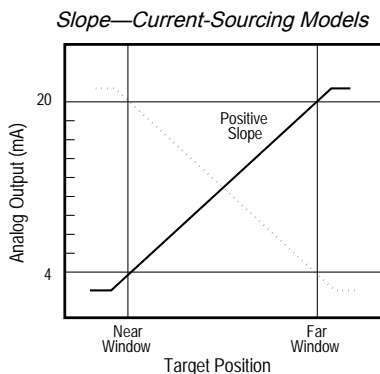

The analog current output tracks slightly beyond each window limit (from 3.8 mA to 20.2 mA)

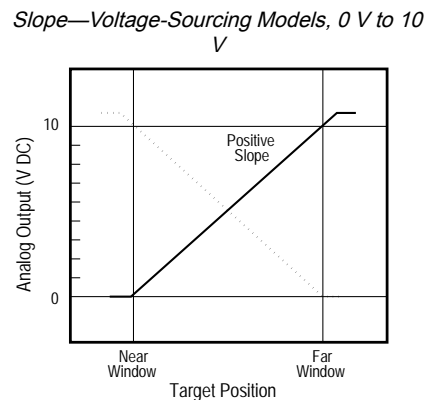

The analog current output tracks slightly beyond the upper window limit (up to 10.2 V)

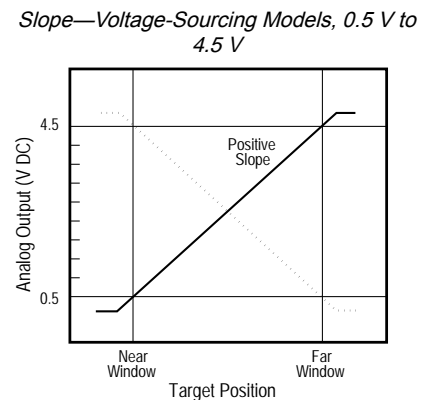

The analog current output tracks slightly beyond each window limit (0V - 5V)

### Detection Area Settings

**Range:** Select **0V-10V** or **0.5V-4.5V**. Available for analog voltage models.

**Target Mode:** Select **Nearest Target** or **Strongest Target**.

**Nearest Target:** Output responds to the nearest target that is over the signal strength threshold.

**Strongest Target:** Output responds to the target with the highest signal strength that is over the signal strength threshold.

**Distance:** Use either the sliders or the fields to define the sensing limits in meters. Available when the **Detection Area** is set to **Radial** on the **General** tab.

**Beam Angle:** Use either the sliders or the fields to define the sensing angle switch points. Available when the **Detection Area** is set to **Radial** on the **General** tab.

**Y/X:** Use either the sliders or the fields to define the sensing area in meters. Available when the **Detection Area** is set to **Rectangular** on the **General** tab.

**Velocity:** Use either the sliders or the fields to define the velocity. Available when **Measurement** is set to **Velocity**.

**Measurement:** Select **Distance (Radial)/Distance (Y)** or **Velocity**.

### Output

**Loss-of-Signal:** Sets the Analog Output value used by the sensor during a loss of signal. When a signal is restored, measurement resumes.

**Hold Last Value**—The Analog Output holds the last value indefinitely during a loss of signal.

**3.5 mA** (analog current models) or **0 V** (analog voltage models)—The Analog Output switches to this value 2 seconds after a loss of signal.

**20.5 mA** (analog current models) **10.5 V** or **5 V** (analog voltage models, depending on the analog range settings)—The Analog Output switches to this value 2 seconds after a loss of signal.

**Averaging:** Use this menu to set the number of measurements that are averaged together for the analog output.

Increasing the averaging improves repeatability but increases the total response speed. The default is 1. The filter can be set to 1, 2, 4, 8, 16, 32, 64, or 128. The total response time is shown under Response Time.

### Response Time

Calculates the total response time, taking into account the general response speed and averaging.

*Analog*

Response Speed	Analog Output Filter Setting							
	1	2	4	8	16	32	64	128
Analog Output Spec (ms)								
Fast	4	8	16	32	64	128	256	512
Medium	40	80	160	320	640	1280	2560	5120
Slow	200	400	800	1600	3200	6400	12,800	25,600

## Live Sensor Data Controls

After connecting to the sensor, data sampling begins automatically (but not recording).

To stop data sampling, click  **Stop**.

To restart data sampling, click  **Play**. This only samples data from the sensor and displays it on the plot; it does not record the data to a log file.

To record data to a log file, click  **Record**. The log file selection prompt displays. Save the log file as desired. The log file format is .csv.

If communication to the sensor is lost, click  **Refresh Device Connection** to reconnect.



## Using Measurement Hold Example

Measurement Hold (The hold time is set to 1 second)

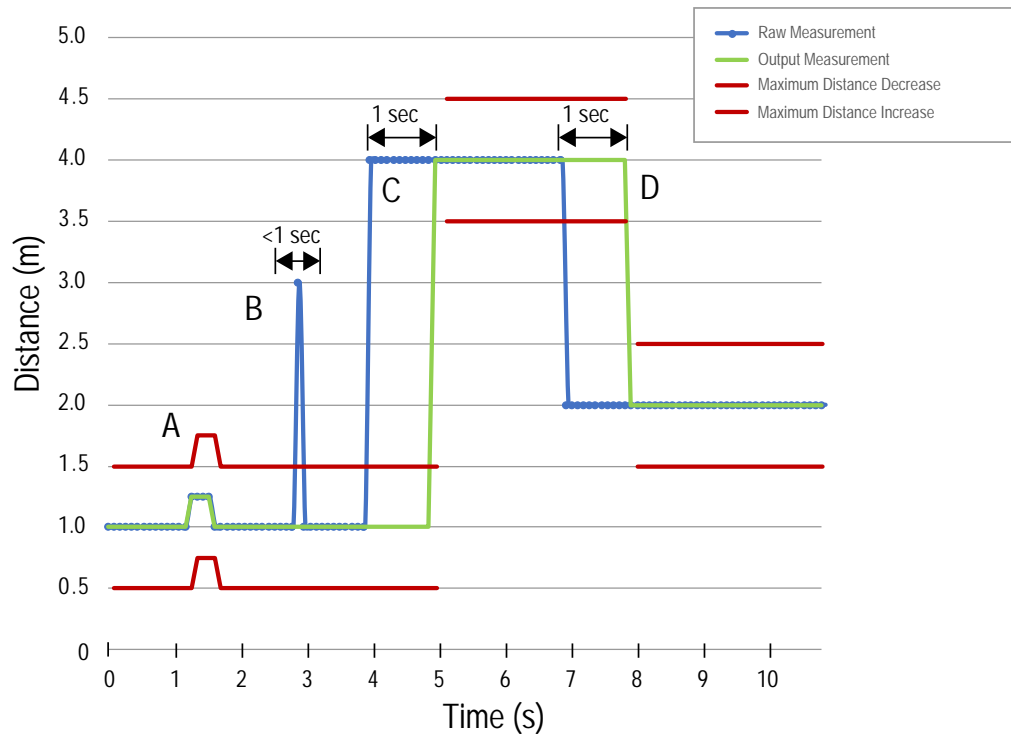

- A The Max Distance Change threshold (red lines) adapts based on the previous Raw Measurement sample (blue lines) as long as that sample was within the previous thresholds.
- B The temporary distance spike in the Raw Measurement (blue lines) is filtered out because the distance increase was outside of the Max Distance Change (red lines). The Output Measurement (green lines) will hold its last measurement.
- C The Raw Measurement change (blue lines) is greater than the Max Distance Change (red lines) so the Output Measurement (green lines) holds its previous value while the Raw Measurement is beyond the Max Distance Change. After the 1 second Hold Time expires, the Output Measurement and Max Distance Change thresholds are updated based on the next Raw Measurement value.
- D The Raw Measurement (blue lines) drops down to a value below the Max Distance Change (red lines) so the Output Measurement (green lines) holds its value for the Hold Time. After the 1 second Hold Time expires, the Output Measurement and Max Distance Change thresholds are updated based on the next Raw Measurement value.

## Chapter Contents

Banner Measurement Sensor Software .....	18
IO-Link Interface .....	18
Remote Input .....	18
Reset the Sensor to Factory Defaults .....	23
Factory Default Settings .....	24

# Chapter 5 Configuring a Sensor

## Banner Measurement Sensor Software

Use the Banner Measurement Sensor software and PRO-KIT to set up the R-GAGE sensor.

For more information visit [www.bannerengineering.com/us/en/products/sensors/software/banner-measurement-sensor-software.html](http://www.bannerengineering.com/us/en/products/sensors/software/banner-measurement-sensor-software.html).

## IO-Link Interface

IO-Link is a point-to-point communication link between a master device and sensor. Use IO-Link to parameterize sensors and transmit process data automatically.

For the latest IO-Link protocol and specifications, see [www.io-link.com](http://www.io-link.com).

Each IO-Link device has an IODD (IO Device Description) file that contains information about the manufacturer, article number, functionality etc. This information can be easily read and processed by the user. Each device can be unambiguously identified via the IODD as well as via an internal device ID. Download the Q90R2's IO-Link IODD package (p/n 241455 for dual discrete models and p/n 241635 for analog models) from Banner Engineering's website at [www.bannerengineering.com](http://www.bannerengineering.com).

Banner has also developed Add On Instruction (AOI) files to simplify ease-of-use between the Q90R2, multiple third-party vendors' IO-Link masters, and the Logix Designer software package for Rockwell Automation PLCs. Three types of AOI files for Rockwell Allen-Bradley PLCs are listed below. These files and more information can be found at [www.bannerengineering.com](http://www.bannerengineering.com).

**Process Data AOIs**—These files can be used alone, without the need for any other IO-Link AOIs. The job of a Process Data AOI is to intelligently parse out the Process Data word(s) in separate pieces of information. All that is required to make use of this AOI is an EtherNet/IP connection to the IO-Link Master and knowledge of where the Process Data registers are located for each port.

**Parameter Data AOIs**—These files require the use of an associated IO-Link Master AOI. The job of a Parameter Data AOI, when working in conjunction with the IO-Link Master AOI, is to provide quasi-realtime read/write access to all IO-Link parameter data in the sensor. Each Parameter Data AOI is specific to a given sensor or device.

**IO-Link Master AOIs**—These files require the use of one or more associated Parameter Data AOIs. The job of an IO-Link Master AOI is to translate the desired IO-Link read/write requests, made by the Parameter Data AOI, into the format a specific IO-Link Master requires. Each IO-Link Master AOI is customized for a given brand of IO-Link Master.

Add and configure the relevant Banner IO-Link Master AOI in your ladder logic program first; then add and configure Banner IO-Link Device AOIs as desired, linking them to the Master AOI as shown in the relevant AOI documentation.

## Remote Input

Use the remote input to program the sensor remotely.

The remote input provides limited programming options and is Active High. This can be configured for Active Low in the Banner Measurement Sensor software by changing the **Sensor Polarity**. For Active High, connect the gray input wire to V+ (10 V DC to 30 V DC), with a remote switch connected between the wire and V+. For Active Low, connect the gray input wire to ground (0 V DC) with a remote switch connected between the wire and ground.

The remote input wire is disabled by default. Pulse the remote input wire 10 times or use the Banner Measurement Sensor software to enable the feature. After enabling the remote input feature, pulse the remote input according to the diagram and the instructions provided in this manual. Remote teach can also be performed using the button on the Pro Converter Cable.

The length of the individual programming pulses is equal to the value T: **0.04 seconds ≤ T ≤ 0.8 seconds.**

Exit remote programming modes by setting the remote input Low for longer than 2 seconds or by waiting for 60 seconds.

*Remote Input Map*

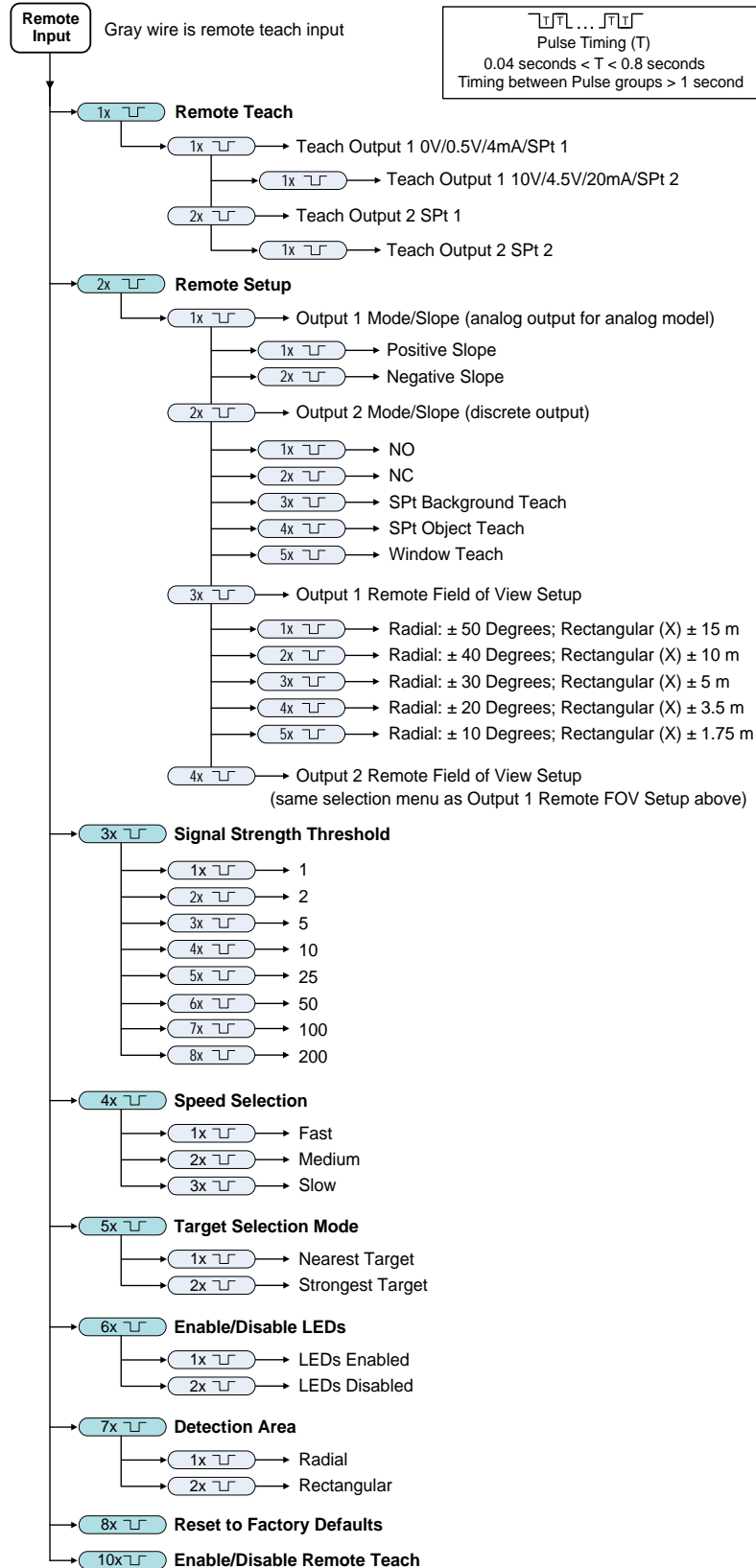

**NOTE:** If a factory reset is performed through the Banner Measurement Sensor Software, the remote input wire becomes disabled (factory default setting). If the sensor is returned to factory defaults by using the remote input wire, the input wire remains enabled and the rest of the settings are restored to factory defaults.

## Remote Teach

Use the following procedure to teach the first and second switch points.

1. Pulse the remote input once. The green Power LED flashes and all other LEDs are off.
2. Present the first point.
3. Teach the switch point.

Action	Result
Teach either Output 1 or Output 2: Output 1: Single-pulse the remote input. Output 2: Double-pulse the remote input.	<p><b>Teach Accepted</b></p> <p>The green Power LED is off, the amber LED of the output being taught flashes while the amber LED of the output not being taught is off. The Green Signal Strength LED indicates signal strength.</p> <p><b>Teach Not Accepted</b></p> <p>The Amber output LED continues to flash, the green Signal Strength LED indicates signal strength. All other LEDs are off.</p> <p>Retry teaching the first point.</p>

4. Present the second point.
5. Teach the switch point.

Action	Result
Single-pulse the remote input.	<p>The green Power LED turns on.</p> <p><b>Teach Accepted</b></p> <p>The sensor returns to run mode.</p> <p><b>Teach Not Accepted</b></p> <p>The green Power LED remains off, the amber LED of the output being taught continues to flash while the amber LED of the output not being taught is off.</p> <p>Retry teaching the second point.</p>

## Remote Setup

Use Remote Setup to set the output mode to normally open or normally closed, change the analog slope, or set the teach mode.

While in remote set up, pulsing the remote wire once configures output 1. For analog models, the slope of the output changes. For discrete output, output 1 and output 2 options are identical.

Changing the Output Mode using remote input affects both the output configuration (normally open versus normally closed) and the Teach mode. The output configuration change takes effect immediately and can be used to change the output between normally open and normally closed or the analog slope without changing the switch point distance. The change in Teach mode does not immediately change the switch point location, but will affect the behavior of the next remote Teach.

## Analog Teach Modes

The default is to teach two separate points. The first taught point is the analog output minimum: 4 mA (current models) or 0 V (voltage models). The second taught point is the analog output maximum: 20 mA (current models) or 4.5 V or 10 V (voltage models, depending on analog output settings).

The analog output will have a positive slope with distance when the first taught point is closer to the sensor than the second taught point. When the first taught point is farther away than the second taught point, the analog output will have a negative slope.

If the two taught points are within 100 mm or less, the sensor views them as the same point. It considers that point as the 20 mA/4.5 V/10 V spot and sets the 4 mA/0 V spot at 150 mm. If a taught point is within the dead zone, the sensor sets that point at 150 mm.

## Discrete Teach Modes

Teaching two separate points creates a window around that range.

Background Teach—Teaching the same point twice (points within 100 mm of each other) sets the switch point 200 mm in front of the taught point.

Object Teach—Teaching the same point twice (points within 100 mm of each other) sets the switch point 100 mm behind the taught point.

Window Teach—Teaching the same point twice (points within 100 mm of each other) sets a window ±50 mm on either side of the taught point, for a total window size of 100 mm.





## Set the Remote Field of View

Use this setting to change the size of the detection area. The settings correspond to the detection area shape, either radial or rectangular.

1. Pulse the remote input twice. The green power LED flashes slowly.
2. Access Remote Field of View Setup.

Action	Result
Select either Output 1 or Output 2: Output 1: Pulse the remote input three times. Output 2: Pulse the remote input four times.	The Green power LED continues to flash slowly.

3. Select the desired field of view.

Action		TEACH Mode	Result
Pulses			
1		Radial: ± 50 Degrees Rectangular (X) ± 15 m	The field of view is set and the green power LED flashes equal to the number of pluses, pauses, and then flashes equal to the number of pulses a second time. Then the sensor exits remote teach and returns to run mode.
2		Radial: ± 40 Degrees Rectangular (X) ± 10 m	
3		Radial: ± 30 Degrees Rectangular (X) ± 5 m	
4		Radial: ± 20 Degrees Rectangular (X) ± 3.5 m	
5		Radial: ± 10 Degrees Rectangular (X) ± 1.75 m	







## Set the Signal Strength Threshold

Use the following procedure to configure the signal strength threshold.

1. Access Signal Strength Threshold.

Action	Result
Triple-pulse the remote input.	The green power LED flashes slowly.

2. Select the desired signal threshold.

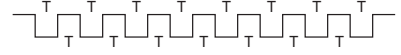
Action		TEACH Mode	Result
Pulses			
1		Signal Strength Threshold = 1	The signal threshold is set and the green power LED flashes equal to the number of pluses, pauses, and then flashes equal to the number of pulses a second time. Then the sensor exits remote teach and returns to run mode.
2		Signal Strength Threshold = 2	
3		Signal Strength Threshold = 5	
4		Signal Strength Threshold = 10	
5		Signal Strength Threshold = 25	
6		Signal Strength Threshold = 50	
7		Signal Strength Threshold = 100	
8		Signal Strength Threshold = 200	



## Set the Speed

Use Speed Selection to set the speed of the sensor.

1. Access Speed Selection.

Action	Result
Four-pulse the remote input.	The green power LED flashes slowly.

2. Select the desired speed.

Action		TEACH Mode	Result
Pulses			
1		Speed = Fast	The speed is set and the power LED flashes equal to the number of pluses, pauses, and then flashes equal to the number of pulses a second time. The sensor exits remote teach and returns to run mode.
2		Speed = Medium	
3		Speed = Slow	



## Target Selection Mode

Use Target Selection to set the target that the output sees.

1. Access Target Selection mode.

Action	Result
Five-pulse the remote input.	The green power LED flashes slowly.

2. Select the desired target.

Action		TEACH Mode	Result
Pulses			
1		Nearest Target—Output responds to the nearest target that is over the signal strength threshold.	The signal threshold is set and the green power LED flashes equal to the number of pluses, pauses, and then flashes equal to the number of pulses a second time. Then the sensor exits remote teach and returns to run mode.
2		Strongest Target—Output responds to the target with the highest signal strength that is over the signal strength threshold.	



## Set the Shape of the Detection Area

Use this setting to switch between detection area shapes radial and rectangular.

1. Access Detection Area selection

Action	Result
Pulse the remote input seven times.	The green power LED flashes slowly.

2. Select the desired detection area.

Action		TEACH Mode	Result
Pulses			
1		Radial	The detection area shape is set and the green power LED flashes equal to the number of pluses, pauses, and then flashes equal to the number of pulses a second time. Then the sensor exits remote teach and returns to run mode.
2		Rectangular	

## Reset the Sensor to Factory Defaults

Reset the sensor to factory default settings using one of two methods.

**NOTE:** If a factory reset is performed through the Banner Measurement Sensor software, the remote input wire becomes disabled (factory default setting). If the sensor is returned to factory default settings by using the remote input wire, the input wire remains enabled and the rest of the settings are restored to factory defaults.

To reset using the Banner Measurement Sensor software, go to **Sensor > Factory Reset**. The sensor indicators flash once, the sensor is reset back to the factory default settings, and a confirmation message displays.

To reset using the remote input, eight-pulse the remote input to apply the factory default settings.

# Factory Default Settings

## General Tab Default Settings

Setting	Factory Default
Response Speed	Medium
Detection Area	Radial
Signal Strength Threshold	1.0
Minimum Active Sensing Range	0 m
Maximum Active Sensing Range	21.0 m
Velocity Filter	All Targets
Detection Sensitivity	Standard
Measurement Hold	Disabled
Remote Input Wire	PNP (Active High)
Remote Input	Disabled
Status LEDs	Enabled

## Analog Tab Default Settings

Setting	Factory Default
Range	4 mA to 20 mA (0 V to 10 V)
4mA/0.5V/0V Point	0.15 m (0.49 ft)
20mA/0.5V/10V Point	20.0 m (65.6 ft)
Loss of Signal	3.5 mA (0 V)
Averaging	1× (no averaging)

## Discrete 1 & 2 Tabs Default Settings

Setting	Factory Default
Output Mode	Switch Point
Target Mode	Nearest Target
Distance Switch Point	20.0 m
Beam Angle Switch Point 1	-60 degrees
Beam Angle Switch Point 2	60 degrees
NO/NC	Normally Open
On Delay	0 ms
Off Delay	500 ms
On Response Time	132 ms
Off Response Time	632 ms



Chapter Contents

FCC Part 15 Class A for Intentional Radiators ..... 26  
 Industry Canada Statement for Intentional Radiators ..... 27  
 ISED Compliance Aircraft Warning..... 27  
 Dimensions..... 27  
 Beam Patterns..... 28

# Chapter 6 Specifications

<b>Response Speed</b>	Fast	Medium	Slow
<b>Response Time</b>	50 ms	150 ms	250 ms
<b>Maximum Velocity</b>	± 9 m/s	± 9 m/s	± 4.5 m/s
<b>Velocity Resolution</b>	0.5 m/s	0.25 m/s	0.15 m/s

**Operating Principle**

Frequency-modulated continuous-wave (FMCW) radar

**Operating Frequency**

60 GHz to 61.5 GHz

**Transmitting Power**

< 20 dBm (E.I.R.P)

**Field of View**

Horizontal: ±60°

Vertical: ±20°

**Distance**

0.15 m to 20 m (0.5 ft to 65.6 ft)

**Distance Resolution**

0.2 m

**Distance Linearity**

>200mm, ±10 mm

**Distance Repeatability**

10 mm

**Velocity Linearity**

±0.01 m/s

**Velocity Repeatability**

0.03 m/s

**Supply Voltage (Vcc)**

Analog Voltage models: 12 V DC to 30 V DC

Analog Current and Dual Discrete models: 10 V DC to 30 V DC

Use only with a suitable Class 2 power supply (UL) or Limited Power Supply (CE)

**Power and Current Consumption, exclusive of load**

Power Consumption: < 2.4 W

Current Consumption: <100 mA at 24 V DC

**Supply Protection Circuitry**

Protected against reverse polarity and transient overvoltages

**Delay at Power-up**

< 2 s

**Output Configuration**

Analog Outputs:

• **Current models**

Discrete Output (Black Wire): IO-Link, push/pull output, configurable PNP or NPN output  
 Analog output (White Wire): 4 mA to 20 mA

• **Voltage models**

Discrete Output (Black Wire): IO-Link, push/pull output, configurable PNP or NPN output  
 Analog output (White Wire): Configurable 0 V to 10 V or 0.5 V to 4.5 V

• **Dual Discrete models**

Discrete Output 1 (Black Wire): IO-Link, push/pull output, configurable PNP or NPN output  
 Discrete Output 2 (White Wire): Configurable PNP or NPN, or Pulse Frequency Modulated (PFM) output

**Output Protection**

Protected against output short-circuit

**Remote Input**

Allowable Input Voltage Range: 0 to Vsupply

Active High (internal weak pull-down): High state > (Vsupply - 2.25 V) at 2 mA maximum

Active Low (internal weak pull-up): Low state < 2.25 V at 2 mA maximum

**Indicators**

**Power LED:** Green, power on

**Signal Strength LED:**

Green Flash: Weak signal

Green Solid: 4x threshold

**Output LEDs:** Amber, target within taught analog span/ discrete output status

**Construction**

**Housing:** Aluminum

**Window:** Polycarbonate

**Connections**

Integral M12 quick disconnect

Models with a quick disconnect require a mating cordset

**Vibration and Mechanical Shock**

All models meet MIL-STD-202G, Method 201A (Vibration: 10 Hz to 60 Hz, 0.06 inch (1.52 mm) double amplitude, 2 hours each along X, Y and Z axes) requirements. Also meets IEC 60947-5-2 (Shock: 30G 11 ms duration, half sine wave) requirements. Method 213B conditions H&I. Shock: 75G with device operating; 100G for non-operation

**Operating Temperature**

-40 °C to +65 °C (-40 °F to +149 °F)

**Temperature Effect**

<±10 mm from -40 °C to +65 °C (-40 °F to +149 °F)

**Environmental Rating**

IP67 per IEC60529

IEC IP69K per BS/ISO 20653:2013

**Country of Origin**

USA

**Certifications**



IND. CONT. EQ. E526767



Banner Engineering BV  
Park Lane, Culliganlaan 2F bus 3  
1831 Diegem, BELGIUM



Turck Banner LTD Blenheim House  
Blenheim Court  
Wickford, Essex SS11 8YT  
GREAT BRITAIN

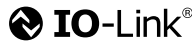

ETSI EN 305 550 V2.1.0  
ETSI EN 305 550-1 V.1.2.1  
ETSI EN 305 550-2 V.1.2.1  
FCC ID: UE3Q90R2-6  
IC: 7044A-Q90R26

Install where not accessible by unauthorized personnel.

The device shall only be accessible for adjustment, programming, or maintenance.

The device was evaluated for IK08 impact energy in accordance with IEC 62262.

**Advanced Capabilities**



**Output Ratings**

Analog Outputs:

- **Current Output (Q90R....-I.. models):** 1 kΩ maximum load resistance at 24 V; maximum load resistance = [(Vcc - 4.5)/0.02 Ω]
- **Voltage Output (Q90R....-U.. models):** 2.5 kΩ minimum load resistance
- **Current rating** = 50 mA maximum each

Black wire specifications per configuration		
IO-Link Push/Pull	Output High	≥ Vsupply - 2.5 V
	Output Low	≤ 2.5 V
PNP	Output High	≥ Vsupply - 2.5 V
	Output Low	≤ 1V (loads ≤ 1 MegΩ)
NPN	Output High	≥ Vsupply - 2.5 V
	Output Low	≤ 2.5 V

White wire specifications per configuration		
PNP	Output High	≥ Vsupply - 2.5 V
	Output Low	≤ 2.5 V (loads ≤ 70 kΩ)
NPN	Output High	≥ Vsupply - 2.5 V
	Output Low	≤ 2.5 V

## FCC Part 15 Class A for Intentional Radiators

This equipment has been tested and found to comply with the limits for a Class A digital device, pursuant to Part 15 of the FCC Rules. These limits are designed to provide reasonable protection against harmful interference when the equipment is operated in a commercial environment. This equipment generates, uses,

and can radiate radio frequency energy and, if not installed and used in accordance with the instruction manual, may cause harmful interference to radio communications. Operation of this equipment in a residential area is likely to cause harmful interference in which case the user will be required to correct the interference at his own expense.

(Part 15.21) Any changes or modifications not expressly approved by the party responsible for compliance could void the user's authority to operate this equipment.

## Industry Canada Statement for Intentional Radiators

This device contains licence-exempt transmitters(s)/receiver(s) that comply with Innovation, Science and Economic Development Canada's licence-exempt RSS(s). Operation is subject to the following two conditions:

1. This device may not cause interference.
2. This device must accept any interference, including interference that may cause undesired operation of the device.

Cet appareil contient des émetteurs/récepteurs exemptés de licence conformes à la norme Innovation, Sciences, et Développement économique Canada. L'exploitation est autorisée aux deux conditions suivantes:

1. L'appareil ne doit pas produire de brouillage.
2. L'utilisateur de l'appareil doit accepter tout brouillage radioélectrique subi, même si le brouillage est susceptible d'en compromettre le fonctionnement.

## ISED Compliance Aircraft Warning

Devices used on aircraft are permitted under the following conditions:

1. Except as allowed in J.2(b), devices are only to be used when the aircraft is on the ground.
2. Devices used in-flight are subject to the following restrictions:
  - a. they shall be used within closed, exclusive on-board, communication networks within the aircraft
  - b. they shall not be used in wireless avionics intra-communication (WAIC) applications where external structural sensors or external cameras are mounted on the outside of the aircraft structure
  - c. they shall not be used on aircraft equipped with a body/fuselage that provides little or no RF attenuation except when installed on unmanned air vehicles (UAVs) and complying with J.2(d)
  - d. devices operating in the 59.3-71.0 GHz band shall not be used except if they meet all of the following conditions:
    - i. they are FDS
    - ii. they are installed within personal portable electronic devices
    - iii. they comply with the relevant requirements in J.3.2(a), J.3.2(b) and J.3.2(c)

## Dimensions

All measurements are listed in millimeters [inches], unless noted otherwise. The measurements provided are subject to change.

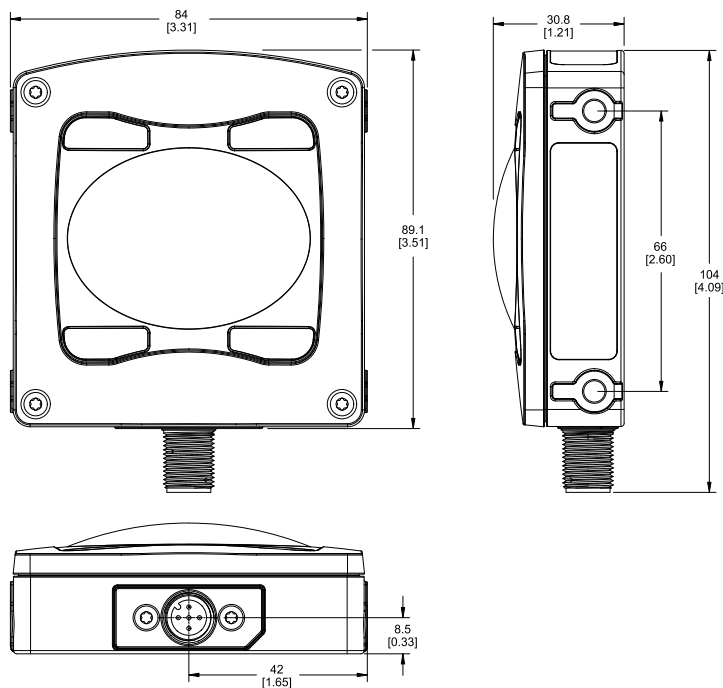

# Beam Patterns

The beam pattern of the radar sensor is dependent on the radar cross section (RCS) of the target.

The beam pattern graphs represent Standard Mode and are guides for representative object detection capabilities based on different-sized radar cross sections and corresponding example real-world targets. Use the following charts as a starting point in application setup. Note that applications vary.

- Use the Beam Width versus Distance chart to understand where corresponding objects can be detected. Adjusting the signal strength threshold also affects the beam pattern when the target is constant.
- Use the Beam Width versus Degrees chart to help determine how much the target can tilt from 90 degrees while still maintaining detection.

Unless otherwise specified, the following beam patterns are shown with Signal Strength Threshold = 1.

## Horizontal

Typical beam pattern, in millimeters, on representative targets

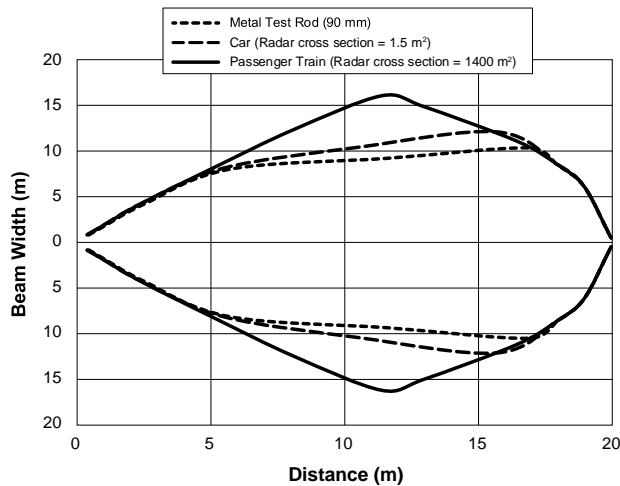

Typical beam pattern, in degrees, on representative targets

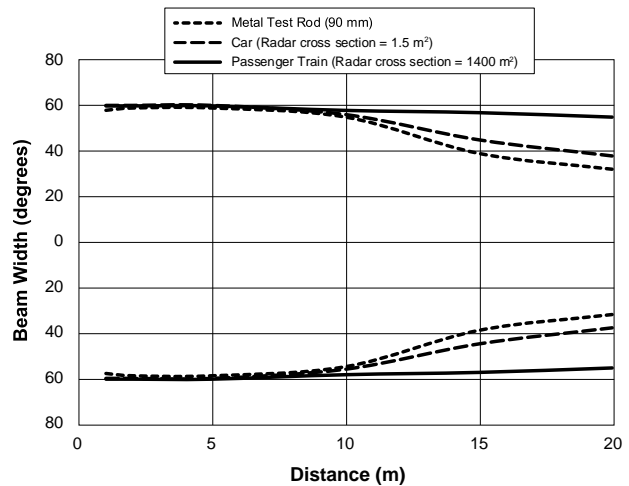

## Vertical

Typical beam pattern, in millimeters, on representative targets

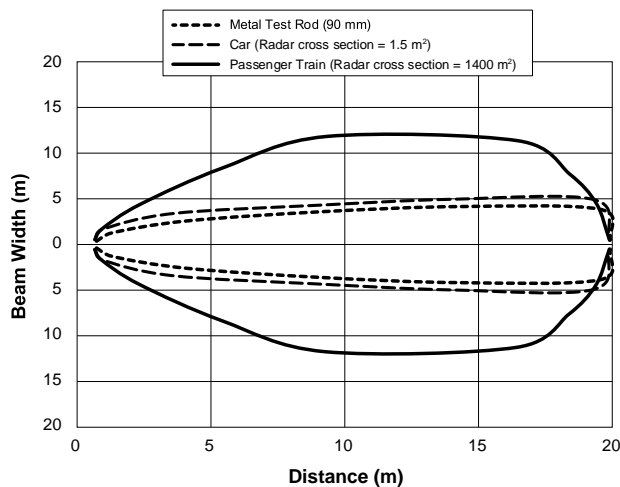

Typical beam pattern, in degrees, on representative targets

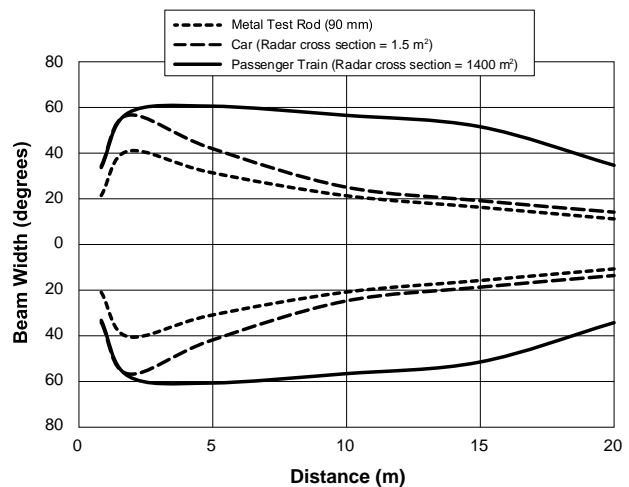

Chapter Contents

Configuration Tool ..... 29  
 Cordsets ..... 29  
 Brackets ..... 30  
 IO-Link Masters ..... 31

# Chapter 7 Accessories

## Configuration Tool

**PRO-KIT**

Includes:

- Pro Converter Cable (MQDC-506-USB)
- Splitter (CSB-M1251FM1251M)
- Power Supply (PSW-24-1)

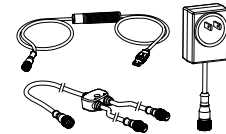

## Cordsets

5-Pin Threaded M12 Cordsets with Shield—Single Ended

Model	Length	Style	Dimensions	Pinout (Female)
MQDEC2-506	2 m (6.56 ft)	Straight		<p>1 = Brown 2 = White 3 = Blue 4 = Black 5 = Gray</p>
MQDEC2-506RA	2 m (6.56 ft)	Right-Angle		

5-Pin Male Threaded and 5-Pin Female Quick Disconnect M12 Cordset with Shield—Double Ended

Model	Length "L1"	Style	Pinout (Male)	Pinout (Female)
MQDEC3-503SS	0.91 m (2.99 ft)	Female Straight/Male Straight		
MQDEC3-506SS	1.83 m (6 ft)			
			<p>1 = Brown 2 = White 3 = Blue</p>	<p>4 = Black 5 = Gray</p>

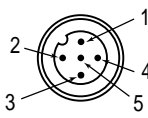
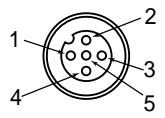
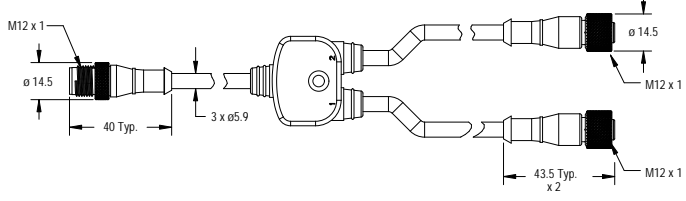
5-Pin M12 Female to M12 Male Flat Junction Splitter Cordsets				
Model	Trunk (Male)	Branches (Female)	Pinout (Male)	Pinout (Female)
CSB-M1251M1251B	0.3 m (0.98 ft)	0.3 m (0.98 ft)		
			<p>1 = Brown 2 = White 3 = Blue</p>	<p>4 = Black 5 = Gray</p>

**NOTE:** The splitter in the PRO-KIT has two male and one female connectors. The CSB-M1251M1251B splitter has one male and two female connectors. Use the CSB-M1251M1251B to connect the sensor to power and a one of the Banner Pro lights with the Pulse Pro output.

## Brackets

### SMBAMSQ90R

- Adjustable mounting bracket
- 14-Gauge 304 stainless steel
- M6 × 1 mounting hardware included

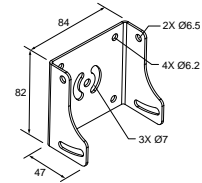

### SMBRAQ90R

- Right-angle mounting bracket
- 14-Gauge 304 stainless steel
- M6 × 1 mounting hardware included

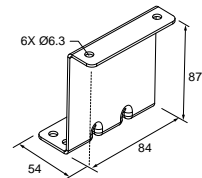

### SMBMAG3

- 3.2 inch diameter magnet with 95 lbs pull force
- Use with LMBWLC90PT, SMBAMS70AS, SMBAMSQ90R bracket
- Hardware for mounting to bracket included

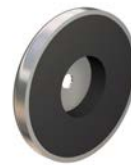

**NOTE:** Use SMBMAG3 with SMBAMSQ90R.

# IO-Link Masters

## DXMR110-8K Series Controller IO-Link Master

- Two female M12 D-Code Ethernet connectors for daisy chaining and communication to a higher-level control system
- Eight female M12 connections for IO-Link master connections
- One male M12 connection for incoming power, one female M12 connection for daisy chaining power
- Product documentation (p/n [233120](#))

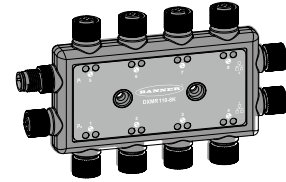

Model		Pinout (Male)	Pinout (Female)
<b>DXMR90-4K Series Controller IO-Link Master</b> <ul style="list-style-type: none"> <li>• One female M12 D-Code Ethernet connector</li> <li>• Four female M12 connections for IO-Link master connections</li> <li>• One male M12 (Port 0) connection for incoming power and Modbus RS-485, one female M12 connection for daisy chaining Port 0 signals</li> <li>• Product documentation (p/n <a href="#">229731</a>)</li> </ul>		<p>1 = Brown 2 = White 3 = Blue 4 = Black</p>	<p>1 = Brown 2 = White 3 = Blue 4 = Black 5 = Gray</p>

Model		Pinout (Male)	Pinout (Female)
<b>R45C-2K-MQ 2-Port IO-Link Master/Modbus Converter</b> <ul style="list-style-type: none"> <li>• Connects two IO-Link devices and provides access via Modbus RTU interface</li> <li>• 5-pin M12 male quick-disconnect connector</li> <li>• Two 4-pin M12 female quick-disconnect connectors</li> </ul>		<p>1 = Brown 2 = White 3 = Blue 4 = Black 5 = Gray</p>	<p>1 = Brown 2 = White 3 = Blue 4 = Black</p>

Model		Pinout (Male)	Pinout (Female)
<b>R90C-4K-MQ 4-Port IO-Link Master/Modbus Converter</b> <ul style="list-style-type: none"> <li>• Connects four IO-Link devices and provides access via Modbus RTU interface</li> <li>• 5-pin M12 male quick-disconnect connector</li> <li>• Four 4-pin M12 female quick-disconnect connectors</li> </ul>		<p>1 = Brown 2 = White 3 = Blue 4 = Black 5 = Gray</p>	<p>1 = Brown 2 = White 3 = Blue 4 = Black</p>

Chapter Contents

Update the Software..... 32  
 Supporting Documentation..... 33  
 Repairs..... 33  
 Contact Us..... 33  
 Banner Engineering Corp. Software Copyright Notice..... 33  
 Banner Engineering Corp Limited Warranty..... 33

# Chapter 8 Product Support

## Update the Software

Use this procedure to update the Banner Measurement Sensor software.

The Banner Measurement Sensor software automatically looks for updated software versions. The symbol  in the lower right corner indicates that a software update is available.

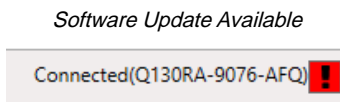

1. Click  in the lower right corner of the software.  
 The Banner Measurement Sensor software update screen displays.

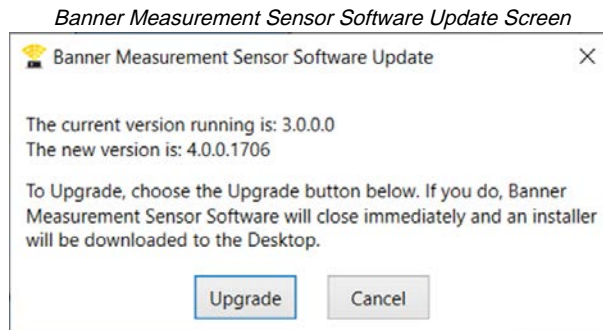

2. Click **Upgrade** to begin the process.  
 The Banner Measurement Sensor software closes and an installer (BannerMeasurementSensorSoftwareInstaller.exe) downloads to the desktop.

**NOTE:** If changes have not been written to the sensor, the system asks whether you want to exit the program. Click **No** to stop the update process and return to the software. Write the changes to the sensor, then return to step 1, above, to update the software.

3. Navigate to and open the file BannerMeasurementSensorSoftwareInstaller.exe.
4. Depending on your system settings, a popup window may appear prompting to allow Banner Measurement Sensor software to make changes to your computer. Click **Yes**.
5. Click **Close** to exit the installer.

The software update is complete.



## Supporting Documentation

The following documentation is available at [www.bannerengineering.com](http://www.bannerengineering.com).

Part number	Document Name
<a href="#">241456</a>	IO-Link Data Reference Guide: Q90R2 60 GHz
<a href="#">241455</a>	Q90R2 Discrete IODD File
<a href="#">B_51900763</a>	Q90R2 KD Discrete IO-Link AOI File
<a href="#">241634</a>	IO-Link Data Reference Guide: Q90R2 Analog 60 GHz
<a href="#">241635</a>	Q90R2 Analog IODD File
<a href="#">B_51915602</a>	Q90R2 KD Analog IO-Link AOI Files

## Repairs

Contact Banner Engineering for troubleshooting of this device. **Do not attempt any repairs to this Banner device; it contains no field-replaceable parts or components.** If the device, device part, or device component is determined to be defective by a Banner Applications Engineer, they will advise you of Banner's RMA (Return Merchandise Authorization) procedure.

**IMPORTANT:** If instructed to return the device, pack it with care. Damage that occurs in return shipping is not covered by warranty.

You may be asked to provide the configuration file and the data log file (.cfg) to aid in troubleshooting.

## Contact Us

Banner Engineering Corp. headquarters is located at: 9714 Tenth Avenue North | Plymouth, MN 55441, USA | Phone: + 1 888 373 6767

For worldwide locations and local representatives, visit [www.bannerengineering.com](http://www.bannerengineering.com).

## Banner Engineering Corp. Software Copyright Notice

© Banner Engineering Corp., All Rights Reserved.

<https://www.bannerengineering.com/us/en/company/terms-and-conditions.html>

**Disclaimer of Warranties.** This software is provided "AS-IS." To the maximum extent permitted by applicable law, Banner, its affiliates, and its channel partners disclaim all warranties, expressed or implied, including any warranty that the software is fit for a particular purpose, title, merchantability, data loss, non-interference with or non-infringement of any intellectual property rights, or the accuracy, reliability, quality or content in or linked to the services. Banner and its affiliates and channel partners do not warrant that the services are secure, free from bugs, viruses, interruption, errors, theft or destruction. If the exclusions for implied warranties do not apply to you, any implied warranties are limited to 60 days from the date of first use of this software.

**Limitation of Liability and Indemnity.** Banner, its affiliates and channel partners are not liable for indirect, special, incidental, punitive or consequential damages, damages relating to corruption, security, loss or theft of data, viruses, spyware, loss of business, revenue, profits, or investment, or use of software or hardware that does not meet Banner minimum systems requirements. The above limitations apply even if Banner and its affiliates and channel partners have been advised of the possibility of such damages. This Agreement sets forth the entire liability of Banner, its affiliates and your exclusive remedy with respect to the software use.

## Banner Engineering Corp Limited Warranty

Banner Engineering Corp. warrants its products to be free from defects in material and workmanship for one year following the date of shipment. Banner Engineering Corp. will repair or replace, free of charge, any product of its manufacture which, at the time it is returned to the factory, is found to have been defective during the warranty period. This warranty does not cover damage or liability for misuse, abuse, or the improper application or installation of the Banner product.

**THIS LIMITED WARRANTY IS EXCLUSIVE AND IN LIEU OF ALL OTHER WARRANTIES WHETHER EXPRESS OR IMPLIED (INCLUDING, WITHOUT LIMITATION, ANY WARRANTY OF MERCHANTABILITY OR FITNESS FOR A PARTICULAR PURPOSE), AND WHETHER ARISING UNDER COURSE OF PERFORMANCE, COURSE OF DEALING OR TRADE USAGE.**

This Warranty is exclusive and limited to repair or, at the discretion of Banner Engineering Corp., replacement. **IN NO EVENT SHALL BANNER ENGINEERING CORP. BE LIABLE TO BUYER OR ANY OTHER PERSON OR ENTITY FOR ANY EXTRA COSTS, EXPENSES, LOSSES, LOSS OF PROFITS, OR ANY**

**INCIDENTAL, CONSEQUENTIAL OR SPECIAL DAMAGES RESULTING FROM ANY PRODUCT DEFECT OR FROM THE USE OR INABILITY TO USE THE PRODUCT, WHETHER ARISING IN CONTRACT OR WARRANTY, STATUTE, TORT, STRICT LIABILITY, NEGLIGENCE, OR OTHERWISE.**

Banner Engineering Corp. reserves the right to change, modify or improve the design of the product without assuming any obligations or liabilities relating to any product previously manufactured by Banner Engineering Corp. Any misuse, abuse, or improper application or installation of this product or use of the product for personal protection applications when the product is identified as not intended for such purposes will void the product warranty. Any modifications to this product without prior express approval by Banner Engineering Corp will void the product warranties. All specifications published in this document are subject to change; Banner reserves the right to modify product specifications or update documentation at any time. Specifications and product information in English supersede that which is provided in any other language. For the most recent version of any documentation, refer to: [www.bannerengineering.com](http://www.bannerengineering.com).

For patent information, see [www.bannerengineering.com/patents](http://www.bannerengineering.com/patents).

 [LinkedIn](#)

 [X \(formerly Twitter\)](#)

 [Facebook](#)

