

# GS60 Guide Spotlight Product Manual



Original Instructions  
p/n: 238181 Rev. A  
March 25, 2024

© Banner Engineering Corp. All rights reserved.

# Contents

## **Chapter 1 Features**

Model Key .....	3
-----------------	---

## **Chapter 2 Wiring..... 5**

## **Chapter 3 Specifications**

FCC Part 15 Class B for Unintentional Radiators.....	7
Industry Canada ICES-003(B).....	7
Dimensions .....	8
Optical Data .....	8

## **Chapter 4 Accessories**

Cordsets .....	10
Mounting Accessories.....	11
Power Supplies.....	12
Dimmers and Switches.....	12

## **Chapter 5 Banner Engineering Corp Limited Warranty**

Mexican Importer .....	14
------------------------	----

Chapter Contents

Model Key ..... 3

# Chapter 1 Features

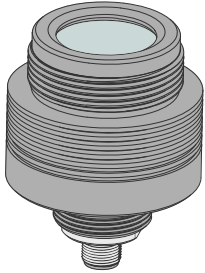

- Continuous or strobed operation, based on model
- 12 V DC to 30 V DC operation
- 60 mm diameter and 30 mm mounting base
- Rugged sealed housing rated to IP66 and IP67
- Cooling rib design for thermal management when used at the highest output for an extended period of time

**IMPORTANT:** Read the following instructions before operating the light. Please download the complete GS60 Guide Spotlight technical documentation, available in multiple languages, from [www.bannerengineering.com](http://www.bannerengineering.com) for details on the proper use, applications, Warnings, and installation instructions of this device.

**IMPORTANT:** Lea el siguiente instructivo antes de operar el luminario. Por favor descargue desde [www.bannerengineering.com](http://www.bannerengineering.com) toda la documentación técnica de los GS60 Guide Spotlight, disponibles en múltiples idiomas, para detalles del uso adecuado, aplicaciones, advertencias, y las instrucciones de instalación de estos dispositivos.

**IMPORTANT:** Lisez les instructions suivantes avant d'utiliser le luminaire. Veuillez télécharger la documentation technique complète des GS60 Guide Spotlight sur notre site [www.bannerengineering.com](http://www.bannerengineering.com) pour les détails sur leur utilisation correcte, les applications, les notes de sécurité et les instructions de montage.

## Model Key

Housing	Color	Lens Angle	Control	Connection
GS60	W	L4		Q
60 mm diameter Guide Spotlight	W = White R = Red G = Green B = Blue Y = Yellow I = Infrared UV395 = 395 nm Ultraviolet	L4 = ± 4 degree lens	Blank = Hi/Low/Off A = Adjustable PWM/Strobe and 1 V to 10 V dimming	Q = Integral 4-pin or 5-pin M12 male quick-disconnect connector <sup>(1)</sup>

<sup>(1)</sup> Hi/Low/Off models have 4-pin quick-disconnect connectors. Adjustable models have 5-pin quick-disconnect connectors.

The following caution applies to white LED models and blue LED models:



**CAUTION:**  
**Risk Group 2: Possibly hazardous optical radiation emitted from this product.**

Do not stare at the operating lamp. May be harmful to the eyes. Risk Group 2 (RG 2) products generally do not pose a realistic optical hazard if aversion responses limit the exposure duration or where lengthy exposures are unrealistic.

- IEC 62471

The following caution applies to ultraviolet models:



**CAUTION:**  
**Risk Group 2: UV Emitted from this product.**

Eye or skin irritation may result from exposure. Use appropriate shielding and eye protection. Risk Group 2 (RG 2) products generally do not pose a realistic optical hazard if aversion responses limit the exposure duration or where lengthy exposures are unrealistic.

- IEC 62471

The following caution applies to infrared models:



**CAUTION:**  
**Risk Group 2: IR Emitted from this product.**

Avoid eye exposure. Use appropriate shielding or eye protection. Risk Group 2 (RG 2) products generally do not pose a realistic optical hazard if aversion responses limit the exposure duration or where lengthy exposures are unrealistic.

- IEC 62471

Chapter Contents

# Chapter 2 Wiring

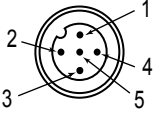
Pinout	Pin Number	Wire Color	High/Low/Off Models	1 V to 10 V Analog Dimming and Strobing/PWM Dimming Models
	Pin 1	Brown	12 V DC to 30 V DC	12 V DC to 30 V DC
	Pin 2	White	Not used	NPN PWM/Strobe Input: For maximum intensity, leave the white wire floating, or connect to 12 V DC to 30 V DC. Connecting to DC common causes the LEDs to shut off.
	Pin 3	Blue	DC common	DC common
	Pin 4	Black	Connect to 12 V DC to 30 V DC for 50% maximum intensity. For maximum intensity, leave the black wire floating or connect to common.	PNP PWM/Strobe Input: For maximum intensity, leave the black wire floating, or connect to DC common. Connecting to 12 V DC to 30 V DC causes the LEDs to shut off.
	Pin 5	Gray	Not present	1 V DC to 10 V DC Analog Dimming  <b>NOTE:</b> Connect to 12 V DC to 30 V DC for maximum intensity, or apply 1 V to 10 V for analog dimming of 10% to 100% intensity.

Chapter Contents

FCC Part 15 Class B for Unintentional Radiators ..... 7  
 Industry Canada ICES-003(B)..... 7  
 Dimensions..... 8  
 Optical Data..... 8

# Chapter 3 Specifications

**Supply Voltage**

12 V DC to 30 V DC  
 Use only with a suitable Class 2 power supply (UL) or SELV power supply (CE)  
 See the electrical characteristics on the product label.

**Supply Protection Circuitry**

Protected against reverse polarity and transient voltages

**Light Source**

One high-intensity LED; see models table for color temperature or wavelengths

**Construction**

Black anodized aluminum housing  
 Polycarbonate window  
 Nickel-plated quick-disconnect connector  
 Black anodized aluminum mounting nut

**Mounting**

30 × 1.5 mm thread base mount  
 Optional M48 knurl nut for front mount; see ["Mounting Accessories" on page 11](#)

**Connections**

Integral 4-pin or 5-pin M12 male quick-disconnect connector

**Operating Temperature**

−40 °C to +50 °C (−40 °F to +122 °F)

**Storage Temperature**

−40 °C to +70 °C (−40 °F to +158 °F)

**Environmental Rating**

IP66, IP67

**LED Lifetime**

Lumen Maintenance - L70  
 When operating within specifications, the output decreases less than 30% after the following time periods:  
 Daylight White: 90,000 hours  
 Red: 70,000 hours  
 Green: 70,000 hours  
 Blue: 50,000 hours  
 Yellow: 60,000 hours  
 UV: 35,000 hours

**Required Overcurrent Protection**



**WARNING:** Electrical connections must be made by qualified personnel in accordance with local and national electrical codes and regulations.

Overcurrent protection is required to be provided by end product application per the supplied table.  
 Overcurrent protection may be provided with external fusing or via Current Limiting, Class 2 Power Supply.  
 Supply wiring leads < 24 AWG shall not be spliced.  
 For additional product support, go to [www.bannerengineering.com](http://www.bannerengineering.com).

Supply Wiring (AWG)	Required Overcurrent Protection (A)	Supply Wiring (AWG)	Required Overcurrent Protection (A)
20	5.0	26	1.0
22	3.0	28	0.8
24	1.0	30	0.5

**Vibration and Mechanical Shock**

Meets IEC 60068-2-6 requirements (Vibration: 10 Hz to 55 Hz, 1.0 mm amplitude, 5 minutes sweep, 30 minutes dwell)  
 Meets IEC 60068-2-27 requirements (Shock: 15G 11 ms duration, half sine wave)

**Certifications**



Banner Engineering BV  
 Park Lane, Culliganlaan 2F bus 3  
 1831 Diegem, BELGIUM



Turck Banner LTD Blenheim House  
 Blenheim Court  
 Wickford, Essex SS11 8YT  
 GREAT BRITAIN



LOW VOLTAGE LUMINAIRE  
 E338626



## Supply Current

Color	Max. Current Draw (A) at 12 V DC	Typical Current Draw (A)			
		12 V DC	24 V DC	30 V DC	50% Intensity at 24 V DC
Daylight White	0.45	0.34	0.18	0.15	0.08
Red	0.45	0.33	0.15	0.12	0.06
Green	0.45	0.405	0.18	0.14	0.06
Blue	0.45	0.41	0.18	0.14	0.065
Yellow	0.45	0.36	0.18	0.145	0.07
IR	0.45	0.185	0.09	0.07	0.045
UV	0.45	0.06	0.035	0.03	0.025

## FCC Part 15 Class B for Unintentional Radiators

(Part 15.105(b)) This equipment has been tested and found to comply with the limits for a Class B digital device, pursuant to part 15 of the FCC Rules. These limits are designed to provide reasonable protection against harmful interference in a residential installation. This equipment generates, uses, and can radiate radio frequency energy and, if not installed and used in accordance with the instructions, may cause harmful interference to radio communications. However, there is no guarantee that interference will not occur in a particular installation. If this equipment does cause harmful interference to radio or television reception, which can be determined by turning the equipment off and on, the user is encouraged to try to correct the interference by one or more of the following measures:

- Reorient or relocate the receiving antenna.
- Increase the separation between the equipment and receiver.
- Connect the equipment into an outlet on a circuit different from that to which the receiver is connected.
- Consult the dealer or an experienced radio/TV technician for help.

(Part 15.21) Any changes or modifications not expressly approved by the party responsible for compliance could void the user's authority to operate this equipment.

## Industry Canada ICES-003(B)

This device complies with CAN ICES-3 (B)/NMB-3(B). Operation is subject to the following two conditions: 1) This device may not cause harmful interference; and 2) This device must accept any interference received, including interference that may cause undesired operation.

Cet appareil est conforme à la norme NMB-3(B). Le fonctionnement est soumis aux deux conditions suivantes : (1) ce dispositif ne peut pas occasionner d'interférences, et (2) il doit tolérer toute interférence, y compris celles susceptibles de provoquer un fonctionnement non souhaité du dispositif.

# Dimensions

All measurements are listed in millimeters [inches], unless noted otherwise.

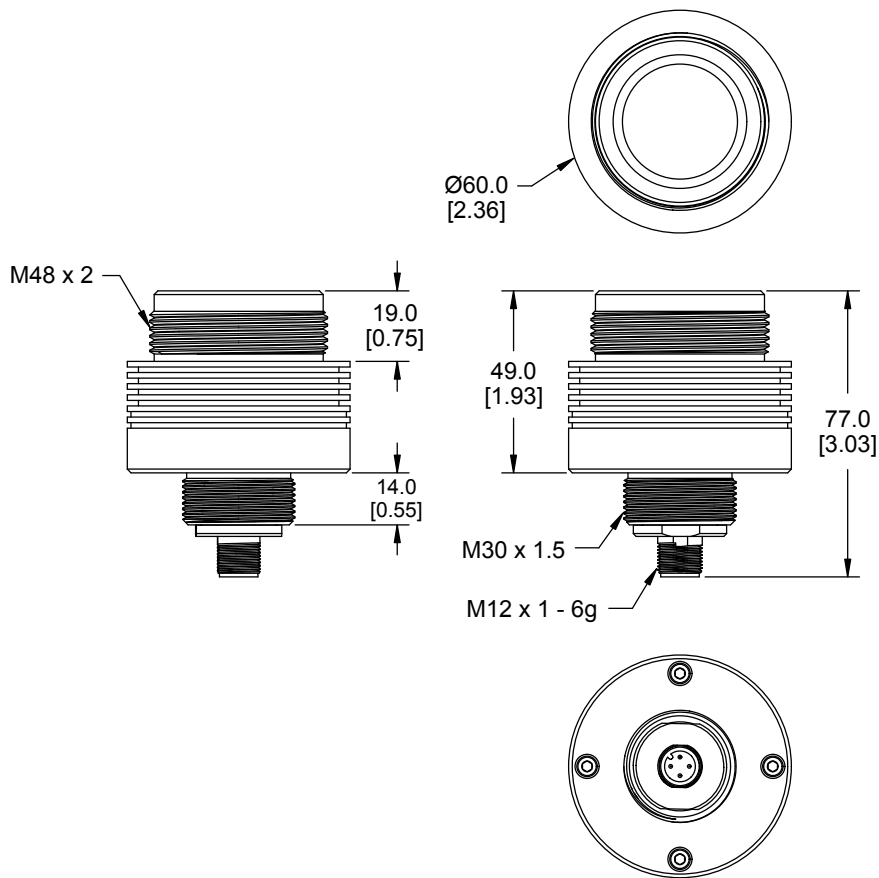

# Optical Data

## Light Characteristics

Values shown are typical at 25°C.

Intensity Setting	Lumens					mWatts	
	White (5000K)	Green (525 nm)	Yellow (590 nm)	Red (625 nm)	Blue (475 nm)	UV395 (395 nm)	IR (850 nm)
High	300	180	155	130	65	110	430
Low	150	90	78	65	33	55	215



**Performance Curves**

Lux and irradiance values shown are typical at 25 °C.

Distance (m)	Max Center Beam Illuminance (Lux)					Max Center Beam Irradiance (mW/m <sup>2</sup> )	
	White (5000K)	Green (525 nm)	Yellow (590 nm)	Red (625 nm)	Blue (475 nm)	UV395 (395 nm)	IR (850 nm)
0.17	400,000	680,000	280,000	288,000	260,000	376,000	1,020,000
0.33	85,000	144,500	59,500	61,200	55,200	79,900	216,700
0.5	41,680	70,900	29,200	30,000	27,000	39,200	106,300
0.67	24,370	41,400	17,000	17,500	15,800	22,900	62,100
0.83	16,610	28,200	11,600	12,000	10,800	15,600	42,400
1	11,700	19,900	8,200	8,400	7,600	11,000	30,000

LED Color	Beam Width FWHM (mm)	Beam Angle FWHM (Deg)
White (5000K)	160	9 (± 4.5°)
Colors / IR / UV395	100	7 (± 3.5°)

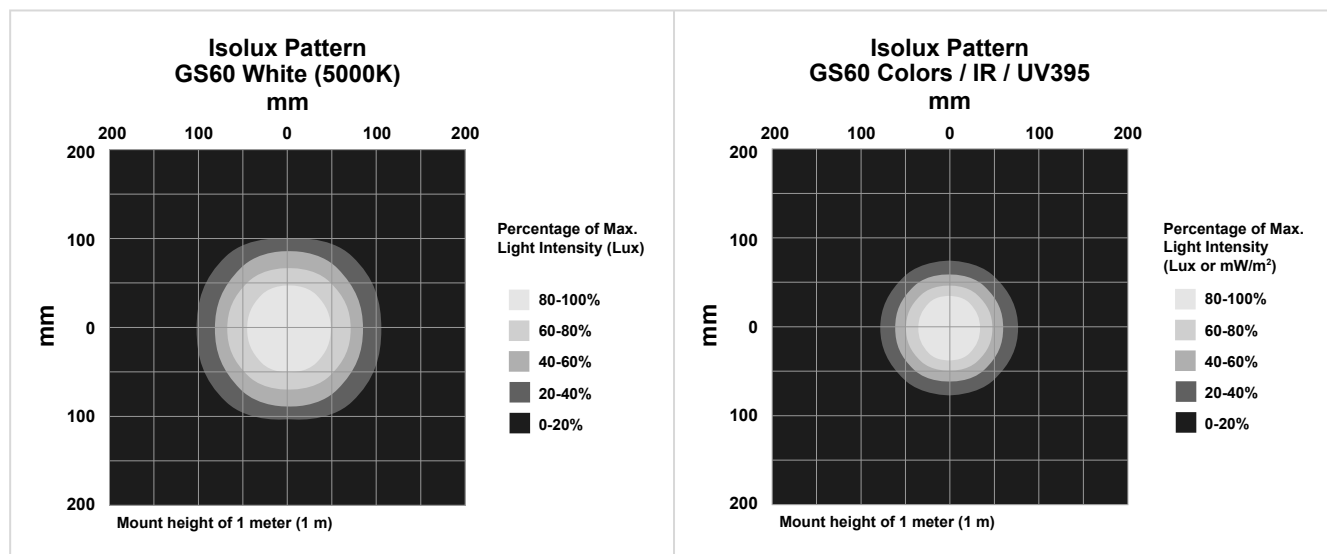

Chapter Contents

Cordsets ..... 10  
 Mounting Accessories ..... 11  
 Power Supplies ..... 12  
 Dimmers and Switches ..... 12

# Chapter 4 Accessories

## Cordsets

4-Pin Threaded M12 Cordsets—Single Ended				
Model	Length	Style	Dimensions	Pinout (Female)
MQDC-406	2 m (6.56 ft)	Straight		
MQDC-415	5 m (16.4 ft)			
MQDC-430	9 m (29.5 ft)			
MQDC-450	15 m (49.2 ft)	Right-Angle		
MQDC-406RA	2 m (6.56 ft)			
MQDC-415RA	5 m (16.4 ft)			
MQDC-430RA	9 m (29.5 ft)			
MQDC-450RA	15 m (49.2 ft)			<p>1 = Brown                  2 = White                  3 = Blue                  4 = Black                  5 = Unused</p>

5-Pin Threaded M12 Cordsets—Single Ended				
Model	Length	Style	Dimensions	Pinout (Female)
MQDC1-501.5	0.5 m (1.5 ft)	Straight		
MQDC1-503	0.9 m (2.9 ft)			
MQDC1-506	2 m (6.5 ft)			
MQDC1-515	5 m (16.4 ft)			
MQDC1-530	9 m (29.5 ft)			
MQDC1-560	18 m (59 ft)			
MQDC1-5100	31 m (101.7 ft)			
Continued on page 11				

Continued from page 10

5-Pin Threaded M12 Cordsets—Single Ended				
Model	Length	Style	Dimensions	Pinout (Female)
MQDC1-506RA	2 m (6.5 ft)	Right-Angle		
MQDC1-515RA	5 m (16.4 ft)			
MQDC1-530RA	9 m (29.5 ft)			
MQDC1-560RA	19 m (62.3 ft)			

## Mounting Accessories

All measurements are in mm.

### ACC-GS60 M48 Front Mount

- Black anodized knurl nut for panel sealing
- Included gasket should be against the product to seal the surface
- Through-wall (near-flush) mounting to protect the product behind a wall

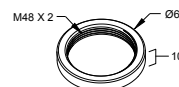

### SMB30A

- Right-angle bracket with curved slot for versatile orientation
- Clearance for M6 (¼ in) hardware
- Mounting hole for 30 mm sensor
- 12-gauge stainless steel

**Hole center spacing:** A to B=40  
**Hole size:** A=Ø 6.3, B= 27.1 × 6.3, C=Ø 30.5

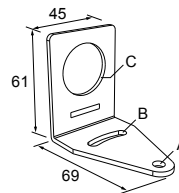

### SMB30SC

- Swivel bracket with 30 mm mounting hole for sensor
- Black reinforced thermoplastic polyester
- Stainless steel mounting and swivel locking hardware included

**Hole center spacing:** A=Ø 50.8  
**Hole size:** A=Ø 7.0, B=Ø 30.0

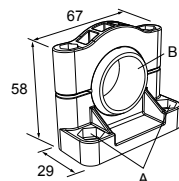

### SMB30FA

- Swivel bracket with tilt and pan movement for precise adjustment
- Mounting hole for 30 mm sensor
- 12-gauge 304 stainless steel
- Easy sensor mounting to extrude rail T-slot
- Metric- and inch-size bolt available

**Bolt thread:** SMB30FA, A= 3/8 - 16 × 2 in; SMB30FAM10, A= M10 - 1.5 × 50  
**Hole size:** B= Ø 30.1

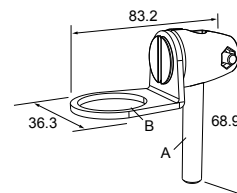

**SMBAMS30RA**

- Right-angle SMBAMS series bracket
- 30 mm hole for mounting sensors
- Articulation slots for 90°+ rotation
- 12-gauge (2.6 mm) cold-rolled steel

**Hole center spacing:** A=26.0, A to B=13.0  
**Hole size:** A=26.8 × 7.0, B=∅ 6.5, C=∅ 31.0

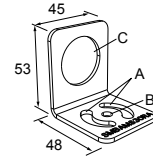

**SMB30MM**

- 12-gauge stainless steel bracket with curved mounting slots for versatile orientation
- Clearance for M6 (¼ in) hardware
- Mounting hole for 30 mm sensor

**Hole center spacing:** A = 51, A to B = 25.4  
**Hole size:** A = 42.6 × 7, B = ∅ 6.4, C = ∅ 30.1

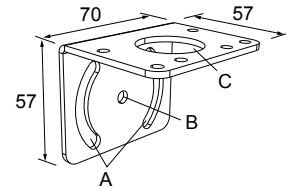

**SMBAMS30P**

- Flat SMBAMS series bracket
- 30 mm hole for mounting sensors
- Articulation slots for 90°+ rotation
- 12-gauge 300 series stainless steel

**Hole center spacing:** A=26.0, A to B=13.0  
**Hole size:** A=26.8 × 7.0, B=∅ 6.5, C=∅ 31.0

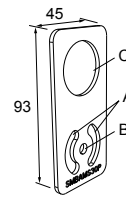

## Power Supplies

**PSW-24-1**

- 24 V DC, 1 A Class 2 UL Listed power supply
- 100 V AC to 240 V AC 50/60 Hz input
- 2 m (6.5 ft) PVC cable with M12 quick disconnect
- Includes Type A (US, Canada, Japan, Puerto Rico, Taiwan), Type C (Germany, France, South Korea, Netherlands, Poland, Spain, Turkey), Type G (United Kingdom, Ireland, Singapore, Vietnam), and Type I (China, Australia, New Zealand) AC detachable input plugs



**PSW-24-2**

- 24 V DC, 2 A Class 2 UL Listed power supply
- 100 V AC to 240 V AC 50/60 Hz input
- 3.5 m (11.5 ft) PVC cable with M12 quick disconnect
- Includes Type A (US, Canada, Japan, Puerto Rico, Taiwan), Type C (Germany, France, South Korea, Netherlands, Poland, Spain, Turkey), Type G (United Kingdom, Ireland, Singapore, Vietnam), and Type I (China, Australia, New Zealand) AC detachable input plugs

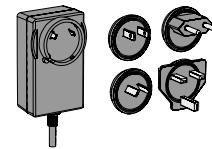

## Dimmers and Switches

**LC15T-127AP1RBGQP**

- In-line capacitive touch switch with M12 connectors
- On/Off/Dimming control and illuminated indication
- Rated for up to 30 V DC and 4 A maximum output current
- Rugged and waterproof IP67 housing

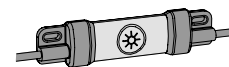

**LC25T-AP1RGBQ**

- In-line capacitive touch switch with M12 connectors
- Used with 3-wire PWM-controlled devices
- Rated for up to 30 V DC and 4 A maximum output current
- Low profile, rugged, water-resistant IP67 design

**WLS28-2PBQ**

- 3-position in-line switch with M12 connectors
- Used with 3-wire DC LED lights
- Rated for up to 30 V DC and 4 A maximum output current
- IP50 housing

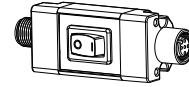

Chapter Contents

Mexican Importer..... 14

# Chapter 5 **Banner Engineering Corp Limited Warranty**

---

Banner Engineering Corp. warrants its products to be free from defects in material and workmanship for one year following the date of shipment. Banner Engineering Corp. will repair or replace, free of charge, any product of its manufacture which, at the time it is returned to the factory, is found to have been defective during the warranty period. This warranty does not cover damage or liability for misuse, abuse, or the improper application or installation of the Banner product.

**THIS LIMITED WARRANTY IS EXCLUSIVE AND IN LIEU OF ALL OTHER WARRANTIES WHETHER EXPRESS OR IMPLIED (INCLUDING, WITHOUT LIMITATION, ANY WARRANTY OF MERCHANTABILITY OR FITNESS FOR A PARTICULAR PURPOSE), AND WHETHER ARISING UNDER COURSE OF PERFORMANCE, COURSE OF DEALING OR TRADE USAGE.**

This Warranty is exclusive and limited to repair or, at the discretion of Banner Engineering Corp., replacement. **IN NO EVENT SHALL BANNER ENGINEERING CORP. BE LIABLE TO BUYER OR ANY OTHER PERSON OR ENTITY FOR ANY EXTRA COSTS, EXPENSES, LOSSES, LOSS OF PROFITS, OR ANY INCIDENTAL, CONSEQUENTIAL OR SPECIAL DAMAGES RESULTING FROM ANY PRODUCT DEFECT OR FROM THE USE OR INABILITY TO USE THE PRODUCT, WHETHER ARISING IN CONTRACT OR WARRANTY, STATUTE, TORT, STRICT LIABILITY, NEGLIGENCE, OR OTHERWISE.**

Banner Engineering Corp. reserves the right to change, modify or improve the design of the product without assuming any obligations or liabilities relating to any product previously manufactured by Banner Engineering Corp. Any misuse, abuse, or improper application or installation of this product or use of the product for personal protection applications when the product is identified as not intended for such purposes will void the product warranty. Any modifications to this product without prior express approval by Banner Engineering Corp will void the product warranties. All specifications published in this document are subject to change; Banner reserves the right to modify product specifications or update documentation at any time. Specifications and product information in English supersede that which is provided in any other language. For the most recent version of any documentation, refer to: [www.bannerengineering.com](http://www.bannerengineering.com).

For patent information, see [www.bannerengineering.com/patents](http://www.bannerengineering.com/patents).

## Mexican Importer

Banner Engineering de México, S. de R.L. de C.V. | David Alfaro Siqueiros 103 Piso 2 Valle oriente | San Pedro Garza Garcia Nuevo León, C. P. 66269

81 8363.2714

 [LinkedIn](#)

 [Twitter](#)

 [Facebook](#)

