

WLF12 Pro Flexible Multicolor Strip Light Product Manual



Original Instructions

p/n: 234631 Rev. E

03-Dec-24

© Banner Engineering Corp. All rights reserved.

Contents

Chapter 1 Features

Pro Editor.....	4
Models	4

Chapter 2 Wiring..... 5

Chapter 3 Cutting Instructions..... 6

Chapter 4 Mounting Instructions 7

Chapter 5 Specifications

FCC Part 15 Class A for Unintentional Radiators	11
Industry Canada ICES-003(A).....	12
Dimensions	12

Chapter 6 Accessories

LC25 LED Controllers.....	13
Mounting Accessories.....	13
Cordsets	14
Splitter Cordsets	15

Chapter 7 Product Support and Maintenance

Repairs	17
Contact Us.....	17
Banner Engineering Corp Limited Warranty.....	17

Chapter Contents

Pro Editor 4
 Models 4

Chapter 1 Features

Banner’s WLF12 Pro Flexible Multicolor Strip Light has been engineered to integrate easily into a broad range of industrial applications and environments. Its rugged yet flexible housing can be cut to length, allowing users to customize the light to their ideal shape. The light installs easily with integral high-strength adhesive tape, for creative use on an AGV, machine, or assembly station. The programmable RGB LEDs offer proven durability, a wide range of colors, and animations to fit any indication needs.

- Industrial light with RGB LEDs that provides flexible and bright status indication
- Programmable using Banner’s LC25 LED Controller, and controllable using the LC25 LED Controller with IO-Link or LC25 LED Controller with Modbus
- Pro Editor software configuration and LC25 LED Controller gives access to color, flashing, intensity, and animation settings, as well as advanced operating modes for displaying distance, count, time, and position
- All models have an M12 connector for plug-and-play indication
- Low-profile, space-saving design
- Rugged, water-resistant design, suitable for damp location use
- Available in sixth lengths from 300 mm to 3000 mm
- Very high-bonding strength tape pre-applied to the back of the light to mount the WLF12 without mounting brackets
- Optional brackets are available for an even more secure installation and positioning
- Both straight and curved installation possible

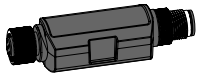
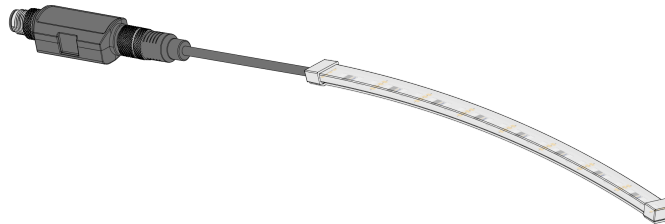

To connect the light to Banner’s Pro Editor Software, use with the LC25C-WLF12-RGB7Q controller.
 To connect the light to an IO-Link master, use with the LC25C-WLF12-KQ controller.
 To connect the light to a Modbus master, use with the LC25-WLF12-SQ controller.
 For more information, refer to the LC25 LED Controller datasheet, p/n 234627.

IMPORTANT: Read the following instructions before operating the light. Please download the complete WLF12 Pro Flexible Multicolor Strip Light technical documentation, available in multiple languages, from www.bannerengineering.com for details on the proper use, applications, Warnings, and installation instructions of this device.

Pro Editor

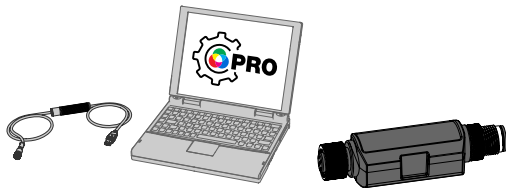

Use Banner's Pro Editor software and Pro Converter Cable to create custom configurations by selecting different colors, flash patterns, and animations.

For more information visit www.bannerengineering.com/proeditor.

IMPORTANT: The WLF12 needs an LC25C-WLF12-RGB7Q to connect to the Pro Editor software.

Models

Model Key

Family	Style	Cascade	Color	Lighted Length (mm)	Construction	Connector ⁽¹⁾
WLF12	P	X	RGB	300	S	QP
WLF12	P = Pro	X = Non-cascadable	RGB = RGB Multicolor	300 = 300 mm	S = Sealed (IP66, IP67, IP69K per ISO 20653)	QP = 150 mm (6 in) PVC-jacketed cable with a 4-pin M12 male quick-disconnect connector
				600 = 600 mm		
				900 = 900 mm		
				1200 = 1200 mm		
				2000 = 2000 mm		
3000 = 3000 mm						

⁽¹⁾ Models with a quick-disconnect connector require a mating cordset.

Chapter Contents

Chapter 2 Wiring

WLF12 Wiring

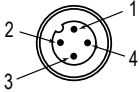
4-pin Male M12 Pinout	Pinout Key and Wiring
	<ul style="list-style-type: none"> 1. Brown - 12 V DC 2. White - BI 3. Blue - DC Common 4. Black - DI

LC25 with WLF12 Wiring⁽¹⁾

LED Controller Wiring

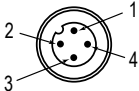
4-pin Male M12 Pinout	Pinout Key and Wiring ⁽²⁾
	<ul style="list-style-type: none"> 1. Brown - Input 1: 12 V DC to 30 V DC 2. White - Input 3: 12 V DC to 30 V DC 3. Blue - DC Common 4. Black - Input 2: 12 V DC to 30 V DC

LED Controller with IO-Link Wiring

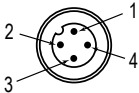
4-pin Male M12 Pinout	Pinout Key and Wiring
	<ul style="list-style-type: none"> 1. Brown - 18 V DC to 30 V DC 2. White - Not used 3. Blue - DC Common 4. Black - IO-Link Communication

LED Controller with Modbus Wiring

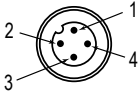
4-pin Male M12 Pinout	Pinout Key and Wiring
	<ul style="list-style-type: none"> 1. Brown - 12 V DC to 30 V DC 2. White - RS-485 (+) 3. Blue - DC Common 4. Black - RS-485 (-)

⁽¹⁾ Contact the factory for instructions on how to use a WLF12 without an LC25.

⁽²⁾ Input functionality can change depending on the configuration created with Pro Editor. Refer to wiring diagrams in the selected mode in Pro Editor.

Chapter Contents

Chapter 3 Cutting Instructions

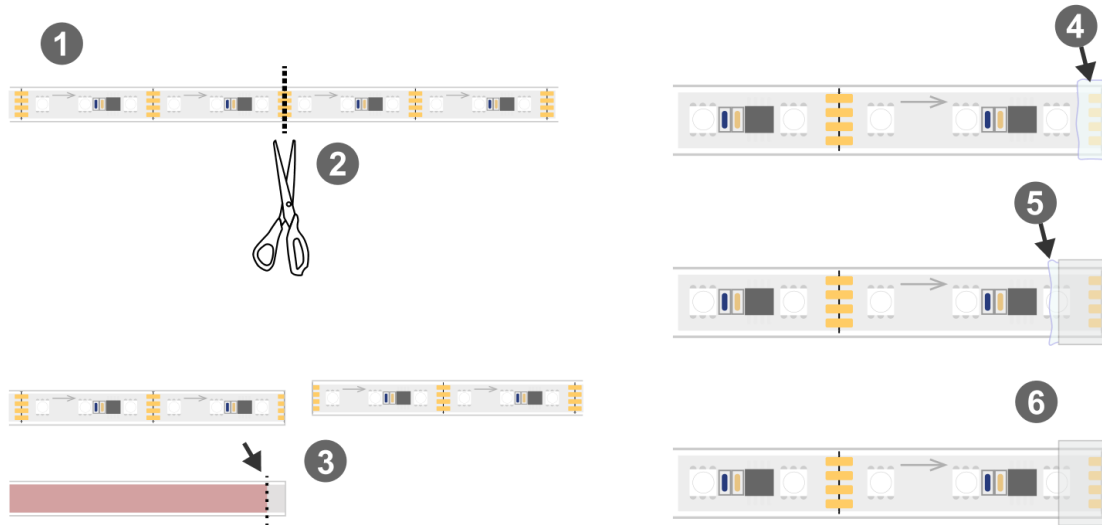

1. Prepare the flexible LED strip light and remove power.
2. Cut along one of the cutting lines located between each section of three LEDs that are spaced every 50 mm.
3. Peel back part of the tape on the back, and trim it off.
4. Cover the cut end of the light with silicone glue.
5. Take the extra supplied silicone end cap, and put it on the end of the light. Press out excess glue.
6. Clean the light of the excess glue.
7. Allow twenty-four hours for the glue to dry.
8. Perform a remote teach operation, if applicable, or set the new number of sections of light through software using the LC25 LED Controller.

Chapter Contents

Chapter 4 Mounting Instructions

Before installation: gather all supporting parts and accessories and remove power from the light.

1. Clean the mounting surface. Ensure that the mounting surface and all other mounting installation parts are dry.

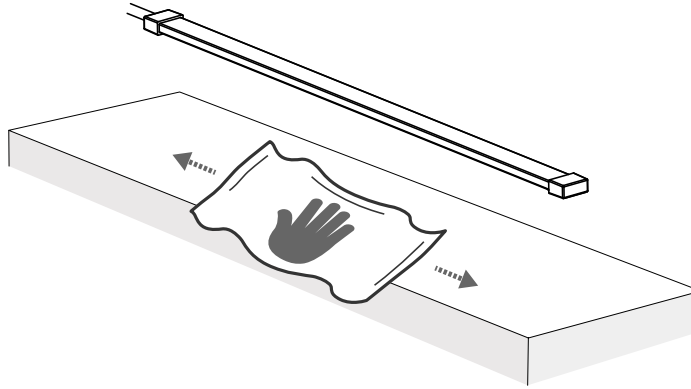

2. Remove the protective liner from the tape on the back of the light strip.

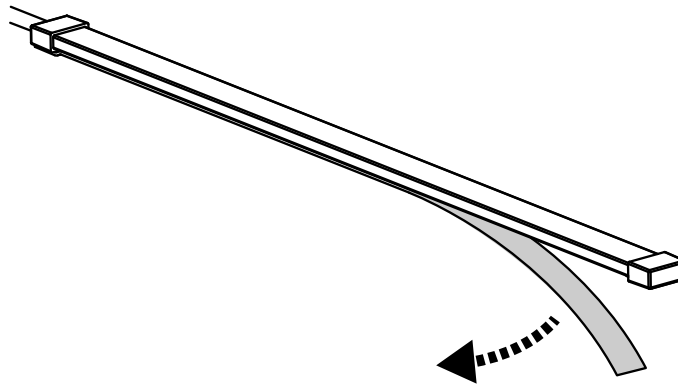

3. Align the light strip in the desired installation position, and press the light strip firmly onto the mounting surface. After installing the light strip, wait twenty-four hours for the tape to adhere completely to the mounting surface. Do not touch or move the light strip during this time period.

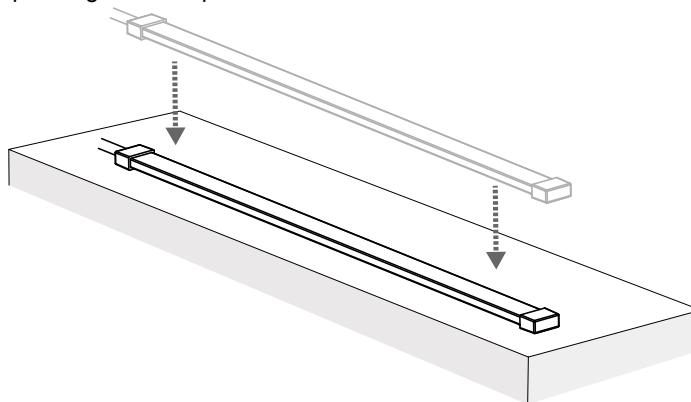

4. Connect the light strip to the controller.
5. Connect the controller to the control device.

6. Confirm that the installation is fastened, the wiring is correct, and that the waterproof connecting wire for docking is tightened.
7. Apply power to the light and the controller.

Chapter Contents

FCC Part 15 Class A for Unintentional Radiators..... 11
 Industry Canada ICES-003(A)..... 12
 Dimensions..... 12

Chapter 5 Specifications

Supply Voltage

Input voltage without a controller: 12 V DC (±10%)
 Input voltage with LC25 LED Controller: 12 V DC to 30 V DC
 Input voltage with LC25 LED Controller with Modbus: 12 V DC to 30 V DC
 Input voltage with LC25 LED Controller with IO-Link: 18 V DC to 30 V DC
 Use only with a suitable Class 2 power supply (UL) or SELV power supply (CE)

NOTICE: The WLF12 is designed to be used with an LC25 and must be no more than 3.05 m (10 ft) apart. Contact the factory for instructions on how to use a WLF12 without an LC25.

 **WARNING:** The WLF12 will be permanently damaged if a supply voltage of greater than 12 V DC is applied directly to the light.

Supply Current

Light Length	WLF12 Only Typical Current (A)	WLF12 + LC25 Typical (A)				
	12 V DC	12 V DC	18 V DC	24 V DC	30 V DC	
300 mm	0.195	0.225	0.17	0.135	0.115	
600 mm	0.39	0.42	0.31	0.24	0.2	
900 mm	0.585	0.615	0.45	0.345	0.285	
1200 mm	0.78	0.81	0.59	0.45	0.37	
2000 mm	1.3	1.33	0.965	0.73	0.6	
3000 mm	1.95	1	0.8	0.65	0.5	

NOTE: The supply current values are reduced for the 3000 mm model with an LC25. See the Application Notes specification.

Supply Protection Circuitry

When a WLF12 is paired with an LC25, it is protected against reverse polarity and transient voltages
 See electrical characteristics on product label

Connections

150 mm (6 in) PVC-jacketed cable with a 4-pin M12 male quick-disconnect connector
 Models with a quick-disconnect require a mating cordset
 Do not spray cable with high-pressure sprayer or cable damage will result.

Operating Temperature

-20 °C to +45 °C (-4 °F to +113 °F)

Storage Temperature

-35 °C to +70 °C (-31 °F to +158 °F)

Environmental Rating

Rated IP66, IP67, IP69K per ISO 20653
 Suitable for damp locations per UL 2108
 Do not spray cable with a high-pressure sprayer or cable damage will result.

Vibration and Mechanical Shock

Vibration: 10 Hz to 55 Hz, 1.0 mm peak-to-peak amplitude per IEC 60068-2-6
 Shock: 15G 11 ms duration, half sine wave per IEC 60068-2-27

Construction

Clear silicone outer housing and end caps
 Internally silicone-encapsulated LEDs
 Very high-bonding strength tape and protective liner pre-applied to the back of the light

Application Notes

When cutting the WLF12, it is important to use the extra end cap supplied along with silicone glue. See "[Cutting Instructions](#)" on page 6. Cutting the WLF12 voids the Limited Warranty.
 Multiple WLF12s can be connected with a splitter cable to a single LC25. Note that each WLF12 displays the same color and animation settings. Do not connect more than 2000 mm (78.74 in) in total length to an LC25.
 For applications with a single 3000 mm (118.11 in) light connected to an LC25, the LED intensity is lower. See the table in the Light Characteristics specification.
 For indoor or outdoor use, if exposure to direct sunlight is avoided.
 Do not use in application with repeated flexing.

Minimum Bend Radius

15 mm

Required Overcurrent Protection



WARNING: Electrical connections must be made by qualified personnel in accordance with local and national electrical codes and regulations.

Overcurrent protection is required to be provided by end product application per the supplied table.
 Overcurrent protection may be provided with external fusing or via Current Limiting, Class 2 Power Supply.
 Supply wiring leads < 24 AWG shall not be spliced.
 For additional product support, go to www.bannerengineering.com.

Supply Wiring (AWG)	Required Overcurrent Protection (A)	Supply Wiring (AWG)	Required Overcurrent Protection (A)
20	5.0	26	1.0
22	3.0	28	0.8

Continued

Continued

Supply Wiring (AWG)	Required Overcurrent Protection (A)	Supply Wiring (AWG)	Required Overcurrent Protection (A)
24	1.0	30	0.5

Mounting

Use pre-applied, very high-bonding strength tape to mount the WLF-12 without mounting brackets, see ["Mounting Instructions" on page 7](#)
 If needed, use mounting bracket LMBWLF12C, see ["Mounting Accessories" on page 13](#)

Certifications



Banner Engineering BV
 Park Lane, Culliganlaan 2F bus 3
 1831 Diegem, BELGIUM



Turck Banner LTD Blenheim House
 Blenheim Court
 Wickford, Essex SS11 8YT
 GREAT BRITAIN



Light Characteristics

Sections of three LEDs can be individually controlled at a time

LED Pitch: 16.67 mm

Beam Angle: 120°

RGB LED PWM Frequency: 2 kHz

Color	Dominant Wavelength (nm) or Color Temperature (CCT)	Color Coordinates ⁽¹⁾		Lumens at Specified Length (Typical at 25 °C)					
		X	Y	300 mm	600 mm	900 mm	1200 mm	2000 mm	3000 mm ⁽²⁾
Daylight White	5000K	0.345	0.352	85	170	255	340	565	400
Incandescent White	2700K	0.46	0.411	70	140	210	280	465	400
Warm White	3000K	0.44	0.404	75	150	225	300	500	400
Fluorescent Light	4100K	0.376	0.374	90	180	270	360	600	400
Neutral White	5700K	0.328	0.337	85	170	255	340	565	400
Cool White	6500K	0.314	0.324	85	170	255	340	565	400
Green	520	0.144	0.703	55	110	165	220	365	550
Red	618	0.686	0.312	30	60	90	120	200	300
Yellow	575	0.45	0.482	80	160	240	320	530	450
Blue	464	0.142	0.044	10	20	30	40	65	100
Magenta	-	0.363	0.162	35	70	105	140	230	250
Cyan	494	0.143	0.365	60	120	180	240	400	450
Amber	590	0.543	0.415	55	110	165	220	365	400
Rose	-	0.529	0.234	30	60	90	120	200	300
Lime Green	561	0.367	0.542	75	150	225	300	500	500
Orange	603	0.62	0.36	40	80	120	160	265	350
Sky Blue	487	0.143	0.26	65	130	195	260	430	400
Violet	-	0.18	0.076	20	40	60	80	130	150
Spring Green	509	0.144	0.66	60	120	180	240	400	600

FCC Part 15 Class A for Unintentional Radiators

This equipment has been tested and found to comply with the limits for a Class A digital device, pursuant to Part 15 of the FCC Rules. These limits are designed to provide reasonable protection against harmful interference when the equipment is operated in a commercial environment. This equipment generates, uses, and can radiate radio frequency energy and, if not installed and used in accordance with the instruction manual, may cause harmful interference to radio communications. Operation of this equipment in a residential area is likely to cause harmful interference in which case the user will be required to correct the interference at his own expense.

(Part 15.21) Any changes or modifications not expressly approved by the party responsible for compliance could void the user's authority to operate this equipment.

⁽¹⁾ Refer to the CIE 1931 (x,y) Chromaticity Diagram to show equivalent color with indicated color coordinates. Actual coordinates may differ ± 5%.

⁽²⁾ The lumen values are reduced for the 3000 model with an LC25. See the Application Notes specification.

Industry Canada ICES-003(A)

This device complies with CAN ICES-3 (A)/NMB-3(A). Operation is subject to the following two conditions: 1) This device may not cause harmful interference; and 2) This device must accept any interference received, including interference that may cause undesired operation.

Cet appareil est conforme à la norme NMB-3(A). Le fonctionnement est soumis aux deux conditions suivantes : (1) ce dispositif ne peut pas occasionner d'interférences, et (2) il doit tolérer toute interférence, y compris celles susceptibles de provoquer un fonctionnement non souhaité du dispositif.

Dimensions

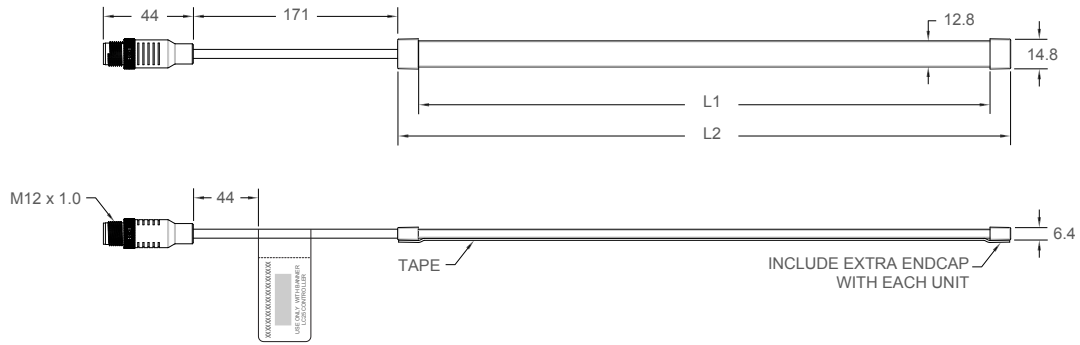

Models	L1	L2
WLF12..300..	300 mm (11.81 in)	325 mm (12.8 in)
WLF12..600..	600 mm (23.6 in)	625 mm (24.61 in)
WLF12..900..	900 mm (35.43 in)	925 mm (36.42 in)
WLF12..1200..	1200 mm (47.24 in)	1225 mm (48.23 in)
WLF12..2000..	2000 mm (78.74 in)	2025 mm (79.72 in)
WLF12..3000..	3000 mm (118.11 in)	3025 mm (119.09 in)

Chapter Contents

LC25 LED Controllers 13
 Mounting Accessories 13
 Cordsets 14
 Splitter Cordsets 15

Chapter 6 Accessories

LC25 LED Controllers

LC25C-WLF12-RGB7Q

- In-line LC25 LED Controller with M12 connectors
- Pro Editor software configuration and three discrete inputs gives access to color, flashing, intensity, and animation settings, as well as advanced operating modes for displaying distance, count, time and position

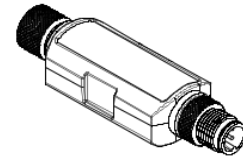

LC25C-WLF12-KQ

- In-line LC25 LED Controller with IO-Link and M12 connectors
- IO-Link gives full access to LED control, color, flashing, intensity, and animation settings, as well as advanced level, gauge, and segment operating modes

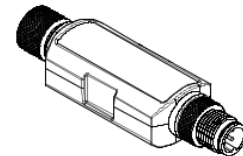

LC25C-WLF12-SQ

- In-line LC25 LED Controller with Modbus and M12 connectors
- Modbus gives full access to LED control, color, flashing, intensity, and animation settings, as well as advanced level, gauge, and segment operating modes

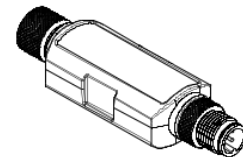

Mounting Accessories

LMBWLF12C

- Set of 10 clamp brackets
- Translucent silicone
- Designed for M3 or No. 4 mounting hardware

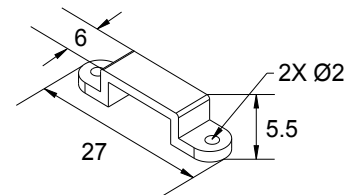

Cordsets

4-Pin Threaded M12 Cordsets—Single Ended				
Model	Length	Style	Dimensions	Pinout (Female)
MQDC-403	1 m (3.28 ft)	Straight		
MQDC-406	2 m (6.56 ft)			
MQDC-410	3 m (9.8 ft)			
MQDC-406RA	2 m (6.56 ft)	Right-Angle		

- 1 = Brown
- 2 = White
- 3 = Blue
- 4 = Black
- 5 = Unused

4-Pin Threaded M12 Cordsets—Double Ended				
Model	Length	Style	Dimensions	Pinout
MQDEC-401SS	0.31 m (1 ft)	Male Straight/ Female Straight		Female
MQDEC-402SS	0.6 m (1.97 ft)			
MQDEC-403SS	0.91 m (2.99 ft)			Male
MQDEC-406SS	1.83 m (6 ft)			
MQDEC-410SS	3 m (9.4 ft)			

- 1 = Brown
- 2 = White
- 3 = Blue
- 4 = Black

Splitter Cordsets

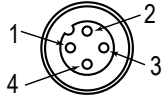
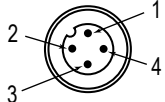
4-Pin Threaded M12 Splitter Cordsets—Flat Junction			
Model	Branches (Female)	Trunk (Male)	Pinout
CSB-M1240M1240	No branch	No trunk	Female  Male  1 = Brown 2 = White 3 = Blue 4 = Black
CSB-M1240M1241	2 × 0.3 m (1 ft)	No trunk	
CSB-M1241M1241	2 × 1 m (3.28 ft)	0.30 m (1 ft)	
CSB-M1243M12413	2 × 1 m (3.28 ft)	1 m (3.28 ft)	
CSB-M1248M1241	2 × 0.3 m (1 ft)	2.44 m (8 ft)	

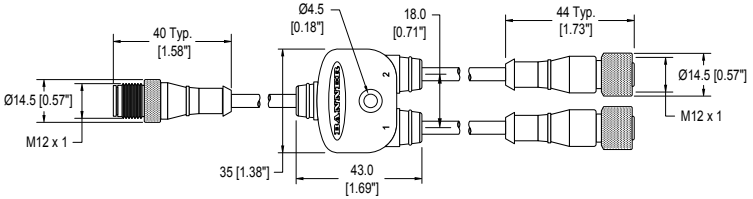

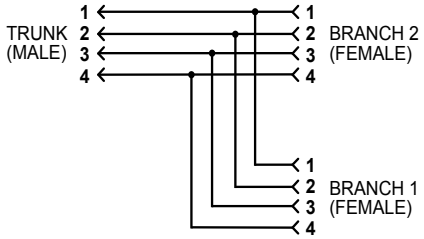
4-Pin M12 Male to 5-Pin M12 Female Splitter Cordset		
Model	Branches (Female)	Wiring
S15YB-M124-M124-0.2M	L1, L2 2 × 0.2 m (7.9 in)	

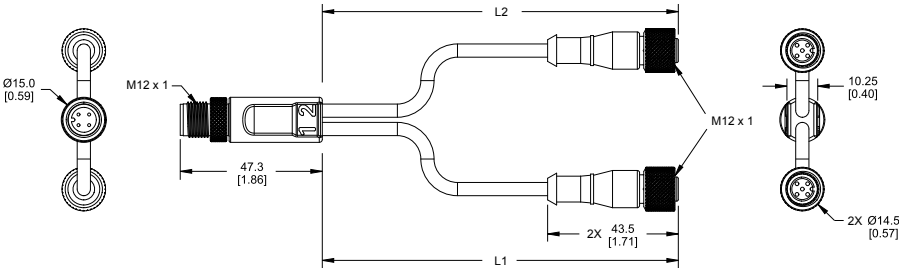

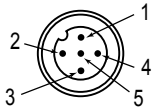
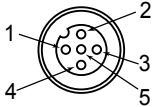
5-Pin Double-Ended M12 Female to M12 Male Flat Junction Splitter Cordsets			
Model	Description	Pinout (Male)	Pinout (Female)
CSB4-M1251M1250	Four (no cable) 5-pin M12 female quick-disconnect connectors One 0.3 m (0.98 ft) cable with a 5-pin M12 male quick-disconnect connector Parallel wiring		

Continued on page 16

Continued from page 15

5-Pin Double-Ended M12 Female to M12 Male Flat Junction Cordsets			
Model	Description	Pinout (Male)	Pinout (Female)
		<p>1 = Brown 2 = White 3 = Blue 4 = Black 5 = Gray</p>	<p>1 = Brown 2 = White 3 = Blue 4 = Black 5 = Gray</p>

Chapter Contents

Repairs	17
Contact Us	17
Banner Engineering Corp Limited Warranty	17

Chapter 7 Product Support and Maintenance

Repairs

Contact Banner Engineering for troubleshooting of this device. **Do not attempt any repairs to this Banner device; it contains no field-replaceable parts or components.** If the device, device part, or device component is determined to be defective by a Banner Applications Engineer, they will advise you of Banner's RMA (Return Merchandise Authorization) procedure.

IMPORTANT: If instructed to return the device, pack it with care. Damage that occurs in return shipping is not covered by warranty.

Contact Us

Banner Engineering Corp. headquarters is located at: 9714 Tenth Avenue North | Plymouth, MN 55441, USA | Phone: + 1 888 373 6767

For worldwide locations and local representatives, visit www.bannerengineering.com.

Banner Engineering Corp Limited Warranty

Banner Engineering Corp. warrants its products to be free from defects in material and workmanship for one year following the date of shipment. Banner Engineering Corp. will repair or replace, free of charge, any product of its manufacture which, at the time it is returned to the factory, is found to have been defective during the warranty period. This warranty does not cover damage or liability for misuse, abuse, or the improper application or installation of the Banner product.

THIS LIMITED WARRANTY IS EXCLUSIVE AND IN LIEU OF ALL OTHER WARRANTIES WHETHER EXPRESS OR IMPLIED (INCLUDING, WITHOUT LIMITATION, ANY WARRANTY OF MERCHANTABILITY OR FITNESS FOR A PARTICULAR PURPOSE), AND WHETHER ARISING UNDER COURSE OF PERFORMANCE, COURSE OF DEALING OR TRADE USAGE.

This Warranty is exclusive and limited to repair or, at the discretion of Banner Engineering Corp., replacement. **IN NO EVENT SHALL BANNER ENGINEERING CORP. BE LIABLE TO BUYER OR ANY OTHER PERSON OR ENTITY FOR ANY EXTRA COSTS, EXPENSES, LOSSES, LOSS OF PROFITS, OR ANY INCIDENTAL, CONSEQUENTIAL OR SPECIAL DAMAGES RESULTING FROM ANY PRODUCT DEFECT OR FROM THE USE OR INABILITY TO USE THE PRODUCT, WHETHER ARISING IN CONTRACT OR WARRANTY, STATUTE, TORT, STRICT LIABILITY, NEGLIGENCE, OR OTHERWISE.**

Banner Engineering Corp. reserves the right to change, modify or improve the design of the product without assuming any obligations or liabilities relating to any product previously manufactured by Banner Engineering Corp. Any misuse, abuse, or improper application or installation of this product or use of the product for personal protection applications when the product is identified as not intended for such purposes will void the product warranty. Any modifications to this product without prior express approval by Banner Engineering Corp will void the product warranties. All specifications published in this document are subject to change; Banner reserves the right to modify product specifications or update documentation at any time. Specifications and product information in English supersede that which is provided in any other language. For the most recent version of any documentation, refer to: www.bannerengineering.com.

For patent information, see www.bannerengineering.com/patents.

 [LinkedIn](#)

 [X \(formerly Twitter\)](#)

 [Facebook](#)

