

Features

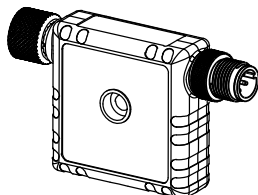

- Compact analog to IO-Link device converter that outputs an analog value, voltage or current, as presented by the IO-Link Master
- Rugged overmolded design meets IP65, IP67, and IP68
- Connects directly to a sensor or anywhere in-line for ease of use

Models

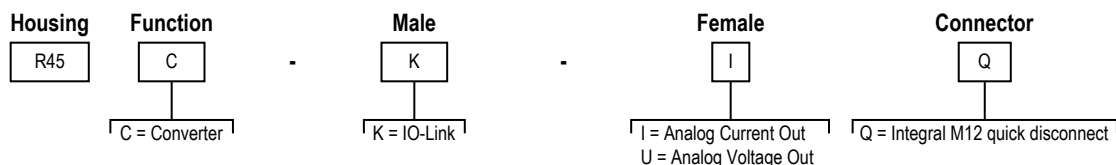

Overview

Analog Out

This converter allows for the user to output an analog value by sending the numerical analog value from the IO-Link Master via Process Data Out (PDO).

PDO Analog Ranges:

- Voltage = 0 mV to 11,000 mV
- Current = 0 μ A to 24,000 μ A

PDO Outside Valid Range (POVR)

If the PDO value sent to this converter is outside of the PDO Analog Range value, then the actual analog output value will be set to the one of the three selectable POVR levels after a 2 second delay:

- Low (default): 0 V or 3.5 mA
- High: 10.5 V or 20.5 mA
- Hold: Level retains previous value indefinitely

NOTE: If a connected IO-Link sensor is changed back to SIO mode, then the previous value will be held.

Status Indicators

The R45C IO-Link Device to Analog Out Converter has two amber LED indicators on both sides for IO-link and analog communications to allow for installation needs and still provide adequate indication visibility. There is also a green LED indicator on both sides of the converter, which signals the device's power status.



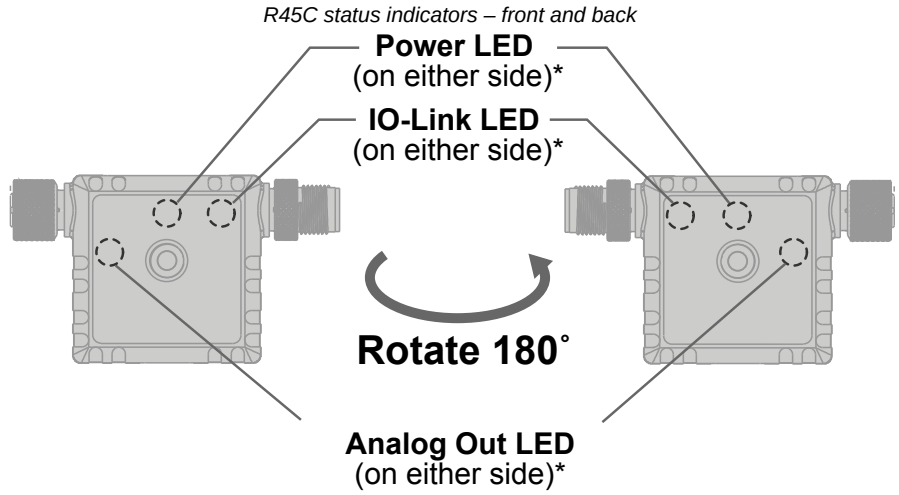

* Indicator LEDs are visible through translucent housing

IO-Link Amber LED	
Indication	Status
Off	IO-Link communications are not present
Flashing Amber (900 ms On, 100 ms Off)	IO-Link communications are active

Analog Out Amber LED	
Indication	Status
Off	Turns off if written PDO analog value is outside the allowable output range
Solid Amber	Turns on if written PDO analog value is inside the allowable output range
Allowable Current Range: 0 mA to 24 mA	
Allowable Voltage Range: 0 V to 11 V	

Installation Instructions

Mechanical Installation

Install the R45C to allow access for functional checks, maintenance, and service or replacement. Do not install the R45C in such a way to allow for intentional defeat.

Fasteners must be of sufficient strength to guard against breakage. The use of permanent fasteners or locking hardware is recommended to prevent the loosening or displacement of the device. The mounting hole (4.5 mm) in the R45C accepts M4 (#8) hardware. See the figure below to help in determining the minimum screw length.

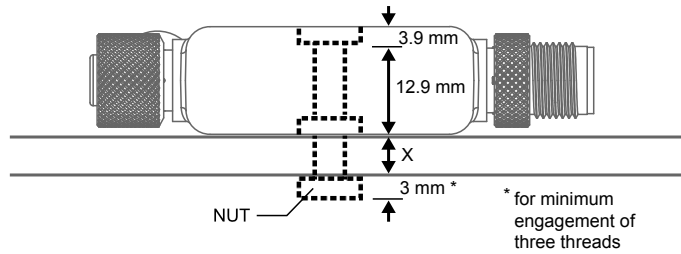

Screw Length (with screw head fitting in counterbore) = 12.9 mm + "X" mm + 3 mm

 **CAUTION:** Do not overtighten the R45C's mounting screw during installation. Overtightening can affect the performance of the R45C.

Wiring Diagrams

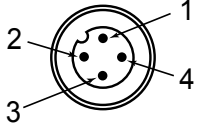
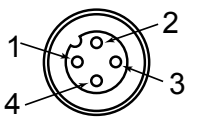
Male	Female	Pin	Wire Color
		1	Brown
		2	White
		3	Blue
		4	Black

Male (IO-Link Master)	Signal Description
Pin 1	18 V DC to 30 V DC
Pin 2	Banner-specific
Pin 3	Ground
Pin 4	IO-Link

Female (Analog Output)	Signal Description
Pin 1	18 V DC to 30 V DC
Pin 2	N/C
Pin 3	Ground
Pin 4	Analog Out

Configuration

The measured current value is available via Process Data as the measure value μA , and the voltage is available in mV.

For more information, see Banner P/N 223174 *R45C Analog Converter (Voltage and Current) IO-Link Data Reference Guide* and Banner P/N 223171 *R45C-K-Analog IO-LINK IODD Files*.

IO-Link®

IO-Link® is a point-to-point communication link between a master device and a sensor and/or light. It can be used to automatically parameterize sensors or lights and to transmit process data. For the latest IO-Link protocol and specifications, please visit www.io-link.com.

For the latest IODD files, please refer to the Banner Engineering Corp website at: www.bannerengineering.com.

Specifications

Supply Voltage

18 V DC to 30 V DC at 50 mA maximum

Power Pass-Through Current

4 A maximum

Supply Protection Circuitry

Protected against reverse polarity and transient voltages

Leakage Current Immunity

400 μA

Resolution

14 bits

Accuracy

0.5%

Indicators

Green: Power

Amber: IO-Link communications

Amber: Analog output value in range

Connections

Integral male/female 4-pin M12 quick disconnect

Construction

Coupling Material: Nickel-plated brass

Connector Body: PVC translucent black

Vibration and Mechanical Shock

Meets IEC 60068-2-6 requirements (Vibration: 10 Hz to 55 Hz, 0.5 mm amplitude, 5 minutes sweep, 30 minutes dwell)

Meets IEC 60068-2-27 requirements (Shock: 15G 11 ms duration, half sine wave)

Certifications



Banner Engineering BV
Park Lane, Culliganlaan 2F bus 3
1831 Diegem, BELGIUM



Turck Banner LTD Blenheim House
Blenheim Court
Wickford, Essex SS11 8YT
GREAT BRITAIN

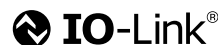

Environmental Rating

IP65, IP67, IP68

NEMA/UL Type 1

Operating Conditions

Temperature: -40 °C to +70 °C (-40 °F to +158 °F)
 90% at +70 °C maximum relative humidity (non-condensing)
Storage Temperature: -40 °C to +80 °C (-40 °F to +176 °F)

Required Overcurrent Protection

 **WARNING:** Electrical connections must be made by qualified personnel in accordance with local and national electrical codes and regulations.

Overcurrent protection is required to be provided by end product application per the supplied table.
 Overcurrent protection may be provided with external fusing or via Current Limiting, Class 2 Power Supply.
 Supply wiring leads < 24 AWG shall not be spliced.
 For additional product support, go to www.bannerengineering.com.

Supply Wiring (AWG)	Required Overcurrent Protection (A)	Supply Wiring (AWG)	Required Overcurrent Protection (A)
20	5.0	26	1.0
22	3.0	28	0.8
24	1.0	30	0.5

FCC Part 15 Class B

This equipment has been tested and found to comply with the limits for a Class B digital device, pursuant to part 15 of the FCC Rules. These limits are designed to provide reasonable protection against harmful interference in a residential installation. This equipment generates, uses and can radiate radio frequency energy and, if not installed and used in accordance with the instructions, may cause harmful interference to radio communications. However, there is no guarantee that interference will not occur in a particular installation. If this equipment does cause harmful interference to radio or television reception, which can be determined by turning the equipment off and on, the user is encouraged to try to correct the interference by one or more of the following measures:

- Reorient or relocate the receiving antenna.
- Increase the separation between the equipment and receiver.
- Connect the equipment into an outlet on a circuit different from that to which the receiver is connected.
- Consult the dealer or an experienced radio/TV technician for help.

Industry Canada ICES-003(B)

This device complies with CAN ICES-3 (B)/NMB-3(B). Operation is subject to the following two conditions: 1) This device may not cause harmful interference; and 2) This device must accept any interference received, including interference that may cause undesired operation.

Cet appareil est conforme à la norme NMB-3(B). Le fonctionnement est soumis aux deux conditions suivantes : (1) ce dispositif ne peut pas occasionner d'interférences, et (2) il doit tolérer toute interférence, y compris celles susceptibles de provoquer un fonctionnement non souhaité du dispositif.

Dimensions

All measurements are listed in millimeters [inches], unless noted otherwise.

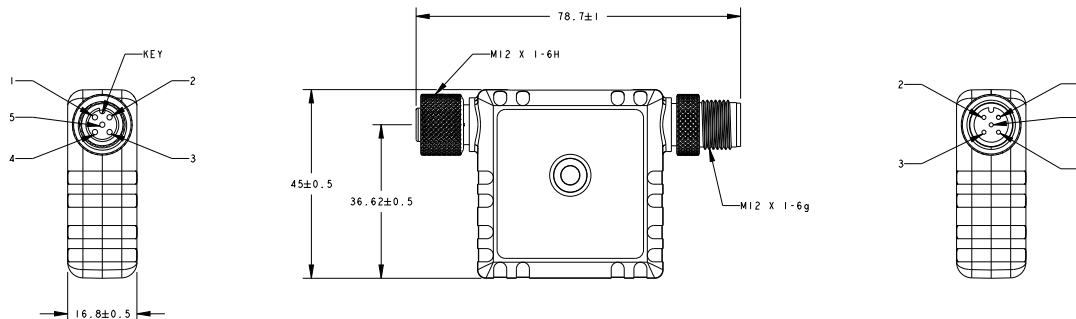

Accessories

Cordsets

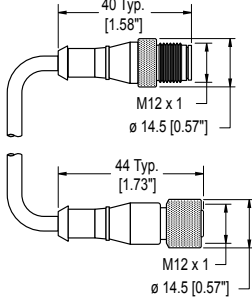
4-Pin Threaded M12 Cordsets—Double Ended				
Model	Length	Style	Dimensions	Pinout
MQDEC-401SS	0.31 m (1 ft)	Male Straight/Female Straight		Female
MQDEC-403SS	0.91 m (2.99 ft)			Female
MQDEC-406SS	1.83 m (6 ft)			Female
MQDEC-412SS	3.66 m (12 ft)			Female
MQDEC-420SS	6.10 m (20 ft)			Female
MQDEC-430SS	9.14 m (30.2 ft)			Female
MQDEC-450SS	15.2 m (49.9 ft)			Male

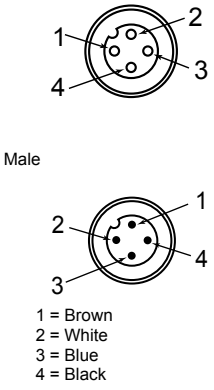

1 = Brown
2 = White
3 = Blue
4 = Black

Banner Engineering Corp Limited Warranty

Banner Engineering Corp. warrants its products to be free from defects in material and workmanship for one year following the date of shipment. Banner Engineering Corp. will repair or replace, free of charge, any product of its manufacture which, at the time it is returned to the factory, is found to have been defective during the warranty period. This warranty does not cover damage or liability for misuse, abuse, or the improper application or installation of the Banner product.

THIS LIMITED WARRANTY IS EXCLUSIVE AND IN LIEU OF ALL OTHER WARRANTIES WHETHER EXPRESS OR IMPLIED (INCLUDING, WITHOUT LIMITATION, ANY WARRANTY OF MERCHANTABILITY OR FITNESS FOR A PARTICULAR PURPOSE), AND WHETHER ARISING UNDER COURSE OF PERFORMANCE, COURSE OF DEALING OR TRADE USAGE.

This Warranty is exclusive and limited to repair or, at the discretion of Banner Engineering Corp., replacement. **IN NO EVENT SHALL BANNER ENGINEERING CORP. BE LIABLE TO BUYER OR ANY OTHER PERSON OR ENTITY FOR ANY EXTRA COSTS, EXPENSES, LOSSES, LOSS OF PROFITS, OR ANY INCIDENTAL, CONSEQUENTIAL OR SPECIAL DAMAGES RESULTING FROM ANY PRODUCT DEFECT OR FROM THE USE OR INABILITY TO USE THE PRODUCT, WHETHER ARISING IN CONTRACT OR WARRANTY, STATUTE, TORT, STRICT LIABILITY, NEGLIGENCE, OR OTHERWISE.**

Banner Engineering Corp. reserves the right to change, modify or improve the design of the product without assuming any obligations or liabilities relating to any product previously manufactured by Banner Engineering Corp. Any misuse, abuse, or improper application or installation of this product or use of the product for personal protection applications when the product is identified as not intended for such purposes will void the product warranty. Any modifications to this product without prior express approval by Banner Engineering Corp will void the product warranties. All specifications published in this document are subject to change; Banner reserves the right to modify product specifications or update documentation at any time. Specifications and product information in English supersede that which is provided in any other language. For the most recent version of any documentation, refer to: www.bannerengineering.com.

For patent information, see www.bannerengineering.com/patents.