

# WLS28 Pro LED Strip Light with IO-Link Instruction Manual



Original Instructions  
p/n: 220962 Rev. B  
October 12, 2023

© Banner Engineering Corp. All rights reserved.

# Contents

## Chapter 1 Features

Models .....	3
Wiring Diagrams .....	4

## Chapter 2 IO-Link Process Data Out (Master to Device) ..... 5

## Chapter 3 Specifications

FCC Part 15 Class B .....	10
Industry Canada ICES-003(B).....	11
Dimensions .....	11
Photometric Data .....	11

## Chapter 4 Accessories

Cordsets .....	17
Brackets .....	17

## Chapter 5 Banner Engineering Corp Limited Warranty

Mexican Importer .....	19
------------------------	----

Chapter Contents

Models ..... 3  
 Wiring Diagrams ..... 4

# Chapter 1 Features

Banner’s WLS28 Pro LED Strip Lights with IO-Link have sturdy aluminum housings, shatterproof windows, and impressive environmental ratings, making them an ideal general-purpose LED light for machine, enclosure, or other industrial lighting applications.



- High quality illumination and indication from RGBW LEDs
- Six white color temperatures for comfort and compatibility
- 13 color options for varied indication and inspection uses
- IO-Link gives full access to individual LED control, color, flashing, intensity, and animation settings, as well as advanced operating modes for displaying distance, count, time, and position
- Available in six lengths from 145 mm to 1130 mm
- Lensed models or choice of clear or diffuse window

**IMPORTANT:** Read the following instructions before operating the light. Please download the complete WLS28 Pro LED Strip Light with IO-Link technical documentation, available in multiple languages, from [www.bannerengineering.com](http://www.bannerengineering.com) for details on the proper use, applications, Warnings, and installation instructions of this device.

**IMPORTANT:** Lea el siguiente instructivo antes de operar el luminario. Por favor descargue desde [www.bannerengineering.com](http://www.bannerengineering.com) toda la documentación técnica de los WLS28 Pro LED Strip Light with IO-Link, disponibles en múltiples idiomas, para detalles del uso adecuado, aplicaciones, advertencias, y las instrucciones de instalación de estos dispositivos.

**IMPORTANT:** Lisez les instructions suivantes avant d'utiliser le luminaire. Veuillez télécharger la documentation technique complète des WLS28 Pro LED Strip Light with IO-Link sur notre site [www.bannerengineering.com](http://www.bannerengineering.com) pour les détails sur leur utilisation correcte, les applications, les notes de sécurité et les instructions de montage.

## Models

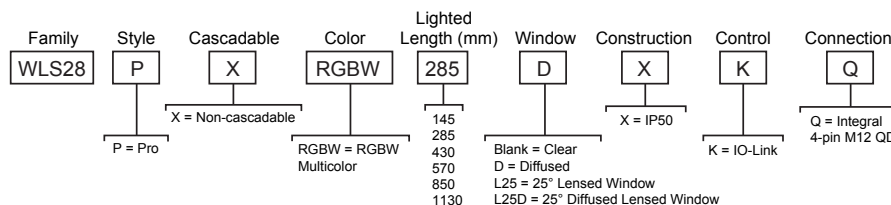

## Wiring Diagrams

Male	Pin	Wire Color	Description
	1	Brown	18 V DC to 30 V DC
	2	White	Not used
	3	Blue	DC common
	4	Black	IO-Link Communication

## Chapter Contents

## Chapter 2 IO-Link Process Data Out (Master to Device)

IO-Link® is a point-to-point communication link between a master device and a sensor and/or light. It can be used to automatically parameterize sensors or lights and to transmit process data. For the latest IO-LINK protocol and specifications, please visit [www.io-link.com](http://www.io-link.com).

For the latest IODD files, please refer to the Banner Engineering Corp website at: [www.bannerengineering.com](http://www.bannerengineering.com).

### Segment Mode

Configure the light to have up to 10 segments which scale in size automatically with the length of the light or select Manual Segment Configuration which allows each segment to have a custom LED width and LED offset from the beginning of each segment to the beginning of the light.

Use process data to set each segment to off, solid on, flash, or animation mode. Use parameter data to change segment number and configuration, color, intensity, flash speed, direction, background, and select animation type.

Animation	Description
Off	Segment is off
Steady	Color 1 is solid on at defined intensity
Flash	Color 1 flashes at defined speed, color intensity, and pattern (normal, strobe, three pulse, SOS, or random)
Two Color Flash	Color 1 and Color 2 flash alternately at defined speed, color intensities, and pattern (normal, strobe, three pulse, SOS, or random)
Two Color Shift	Color 1 and Color 2 flash alternately on adjacent LEDs at defined speed and color intensities
Ends Steady	Color 1 is solid on in the center of the segment as defined by Percent Width of Color 1 at defined color intensity while Color 2 is solid on for half of the remaining percentage on each end of the segment at defined color intensity
Ends Flash	Color 1 is solid on in the center of the segment as defined by Percent Width of Color 1 at defined color intensity while Color 2 flashes on for half of the remaining percentage on each end of the segment at defined speed, color intensity, and pattern (normal, strobe, three pulse, SOS, or random)
Scroll	Color 1 fills the segment as defined by Percent Width of Color 1 and moves in one direction up or down against the background of Color 2 at the defined speed, color intensities, style, and direction
Center Scroll	Color 1 fills the segment as defined by Percent Width of Color 1 and moves in or out from the center of the segment against the background of Color 2 at the defined speed, color intensities, style, and direction
Bounce	Color 1 fills the segment as defined by Percent Width of Color 1 and moves up and down against the background of Color 2 at the defined speed, color intensities, and style
Center Bounce	Color 1 fills the segment as defined by Percent Width of Color 1 and moves in and out from the center of the segment against the background of Color 2 at the defined speed, color intensities, and style
Intensity Sweep	Color 1 repeatedly increases and decreases intensity between 0% to 100% at defined speed and color intensity
Two Color Sweep	Color 1 and Color 2 define the end values of a line across the color gamut. The segment continuously displays a color by moving along the line at the defined speed and color intensities
Spectrum	The segment scrolls through the 13 predefined colors with a different color on each LED at the defined speed, Color 1 intensity, and direction

### Run Mode

Use process data to control entire light and select color, intensity, flash, direction, and animations. Use parameter data to create custom colors, intensity, and flash speeds.

Animation	Description
Off	Light is off
Steady	Color 1 is solid on at defined intensity
Flash	Color 1 flashes at defined speed, color intensity, and pattern (normal, strobe, three pulse, SOS, or random)

Continued on page 6

Continued from page 5

Animation	Description
Two Color Flash	Color 1 and Color 2 flash alternately at defined speed, color intensities, and pattern (normal, strobe, three pulse, SOS, or random)
Two Color Shift	Color 1 and Color 2 flash alternately on adjacent LEDs at defined speed and color intensities
Ends Steady	Color 1 is solid on in the center of the light as defined by Percent Width of Color 1 at defined color intensity while Color 2 is solid on for half of the remaining percentage on each end of the light at defined color intensity
Ends Flash	Color 1 is solid on in the center of the light as defined by Percent Width of Color 1 at defined color intensity while Color 2 flashes on for half of the remaining percentage on each end of the light at defined speed, color intensity, and pattern (normal, strobe, three pulse, SOS, or random)
Scroll	Color 1 fills the light as defined by Percent Width of Color 1 and moves in one direction up or down against the background of Color 2 at the defined speed, color intensities, style, and direction
Center Scroll	Color 1 fills the light as defined by Percent Width of Color 1 and moves in or out from the center of the light against the background of Color 2 at the defined speed, color intensities, style, and direction
Bounce	Color 1 fills the light as defined by Percent Width of Color 1 and moves up and down against the background of Color 2 at the defined speed, color intensities, and style
Center Bounce	Color 1 fills the light as defined by Percent Width of Color 1 and moves in and out from the center of the light against the background of Color 2 at the defined speed, color intensities, and style
Intensity Sweep	Color 1 repeatedly increases and decreases intensity between 0% to 100% at defined speed and color intensity
Two Color Sweep	Color 1 and Color 2 define the end values of a line across the color gamut. The light continuously displays a color by moving along the line at the defined speed and color intensities
Spectrum	The light scrolls through the 13 predefined colors with a different color on each LED at the defined speed, Color 1 intensity, and direction

### Level Mode

Use process data to set the level value. Use parameter data to set range, thresholds, colors, intensities, flash speeds, background, and animation types.

General Settings	Description
Level Mode Value	Value of the level of the light (between 0 to 65,535)
Full Scale Value	Set the upper limit of the Level Mode Value (between 0 to 65,535)
Background Color and Intensity	A defined color and intensity is displayed on LEDs that are not active
Dominance	Dominant: The entire light displays the active threshold color Non-Dominant: LEDs displays their defined threshold colors
Sub-Segment Style	If Level Mode Value is a partial percentage of an LED, select if segment will be on steady or analog dimmed to the partial percentage
Filtering	Smooths the input signal by varying the sample size None: There is no filtering Low: The sample size is short and changes to the input signal are more noticeable High: The sample size is long and changes to the input signal are less noticeable
Hysteresis	Determines the signal value change needed to transition between thresholds and to prevent chatter None: The value follows the input signal High: A large value change is needed to transition between thresholds

Base and Threshold 1-4 Settings	Description
Threshold Type: Base	A defined animation state is displayed on LEDs that are not defined within a threshold
Threshold Type: 1-4	Level Mode Values that conform to Threshold Comparison Type $\leq$ or $\geq$ and the Threshold Value Percent are displayed on LEDs as defined by the threshold color, intensity, flash speeds, and run mode animation types

### Dim and Blend Mode

Dim and blend mode uses the light to finely adjust the intensity of one color, or blend between two or three colors.

Use process data to set the dim and blend mode value. Use parameter data to set number of colors, range, colors, and intensities.

General Settings	Description
Dim and Blend Mode Value	Value of the intensity of the light in 1 Color mode or value of the blend between colors in 2 and 3 Color mode (between 0 to 65,535)
Full Scale Value	Set the upper limit of the Dim and Blend Mode Value (between 0 to 65,535)
Number of Colors	1: Color 1 is solid on at intensity defined by the percentage of Dim and Blend Mode Value to the Full Scale Value when Color 1 Intensity is set to high 2: Color 1 and Color 2 define the end values of a line across the color gamut. The light displays a blended color and moves along the line as defined by the Dim and Blend Mode Value and color intensities 3: Color 1 and Color 2 define the beginning and end value of one line across the color gamut. Color 2 and Color 3 define the beginning and end value of a second line across the color gamut. The light displays a blended color and moves along the two lines as defined by the Dim and Blend Mode Value and color intensities
Filtering	Smooths the input signal by varying the sample size None: There is no filtering Low: The sample size is short and changes to the input signal are more noticeable High: The sample size is long and changes to the input signal are less noticeable

### Gauge Mode

Gauge mode uses the light to display a colored band of LEDs in a position proportional to the gauge mode value.

Use process data to set the gauge mode value. Use parameter data to set range, thresholds, colors, intensities, flash speeds, background, and animation types.

General Settings	Description
Gauge Mode Value	Value of the band position within the light (between 0 to 65,535)
Full Scale Value	Set the upper limit of the Gauge Mode Value (between 0 to 65,535)
Filtering	Smooths the input signal by varying the sample size None: There is no filtering Low: The sample size is short and changes to the input signal are more noticeable High: The sample size is long and changes to the input signal are less noticeable
Hysteresis	Determines the signal value change needed to transition between thresholds and to prevent chatter None: The value follows the input signal High: A large value change is needed to transition between thresholds

Center, Threshold 1, and Threshold 2 Settings	Description
Threshold Type: Center	Gauge Mode Values not in Threshold 1 or Threshold 2 are positioned on a band of LEDs as defined by the center threshold color, intensity, flash speeds, backgrounds, band size percent width, and run mode animation types
Threshold Type: 1 & 2	Gauge Mode Values that conform to Threshold Comparison Type $\leq$ or $\geq$ and the Threshold Value Percent are positioned on a band of LEDs as defined by the threshold color, intensity, flash speeds, backgrounds, band size percent width, and run mode animation types

### LED Mode

Use process data to turn on and select a color for each individual LED. Use parameter to set global intensity.

General Settings	Description
LED 1-64 Color	Set chosen LED to off or to defined color
LED Mode Intensity	Defines intensity of all LEDs turned on

### Demo Mode

Demo sequence cycles through 15 different configurations to highlight example applications.

*Blank page*



Chapter Contents

FCC Part 15 Class B ..... 10  
 Industry Canada ICES-003(B)..... 11  
 Dimensions..... 11  
 Photometric Data ..... 11

# Chapter 3 Specifications

**Supply Voltage**

18 V DC to 30 V DC

Use only with suitable Class 2 power supply (UL) or a SELV power supply (CE)

Light Length	Typical Current			Maximum Current A
	18 V DC	24 V DC	30 V DC	
145 mm	0.24	0.18	0.15	0.275
285 mm	0.48	0.36	0.3	0.55
430 mm	0.72	0.54	0.45	0.825
570 mm	0.96	0.72	0.6	1.1
850 mm	1.44	1.08	0.9	1.65
1130 mm	1.92	1.44	1.2	2.2

**NOTE:** Different IO-Link masters have different maximum current limits. Use CSB-M1251FM1251M splitter cable and external power supply if needed. See Accessories.

**Supply Protection Circuitry**

Protected against reverse polarity and transient voltages

**Mounting**

(2) SMBWLS28RA swivel brackets and (4) screws included

**Construction**

- Housing: Clear anodized aluminum
- End Caps: Painted zinc
- Polycarbonate window on clear and diffuse plastic models, acrylic window on L25 models
- Brackets: Zinc plated steel

**Connections**

Integral 4-pin M12 male quick-disconnect connector

**Environmental Rating**

Rated IP50

**Vibration and Mechanical Shock**

- Vibration: 10 Hz to 55 Hz, 1.0 mm peak-to-peak amplitude per IEC 60068-2-6
- Shock: 15G 11 ms duration, half sine wave per IEC 60068-2-27

**Operating Temperature**

-40 °C to +50 °C (-40 °F to +122 °F)

**Storage Temperature:** -40 °C to +70 °C (-40 °F to +158 °F)

**Required Overcurrent Protection**



**WARNING:** Electrical connections must be made by qualified personnel in accordance with local and national electrical codes and regulations.

Overcurrent protection is required to be provided by end product application per the supplied table.

Overcurrent protection may be provided with external fusing or via Current Limiting, Class 2 Power Supply.

Supply wiring leads < 24 AWG shall not be spliced.

For additional product support, go to [www.bannerengineering.com](http://www.bannerengineering.com).

Supply Wiring (AWG)	Required Overcurrent Protection (A)	Supply Wiring (AWG)	Required Overcurrent Protection (A)
20	5.0	26	1.0
22	3.0	28	0.8
24	1.0	30	0.5

**Certifications**

 Banner Engineering BV  
 Park Lane, Culliganlaan 2F bus 3  
 1831 Diegem, BELGIUM

 Turck Banner LTD Blenheim House  
 Blenheim Court  
 Wickford, Essex SS11 8YT  
 GREAT BRITAIN

 c UL US LISTED

 IO-Link®

## Light Characteristics

RGBW LED PWM Frequency: 2kHz

Color	Dominant Wavelength (nm) or Color Temperature (CCT)	CRI	Color Coordinates <sup>(1)</sup>		Lumens at Specified Length (Typical at 25 °C) <sup>(2)</sup>					
			X	Y	145 mm	285 mm	430 mm	570 mm	850 mm	1130 mm
Daylight White	5000K	93	0.345	0.352	245	490	735	980	1470	1960
Incandescent White	2700K	42	0.46	0.411	110	220	330	440	660	880
Warm White	3000K	50	0.44	0.404	110	220	330	440	660	880
Fluorescent White	4100K	80	0.376	0.374	205	410	615	820	1230	1640
Neutral White	5700K	86	0.328	0.337	265	530	795	1060	1590	2120
Cool White	6500K	85	0.314	0.324	265	530	795	1060	1590	2120
Green	522	-	0.153	0.704	145	290	435	580	870	1160
Red	620	-	0.688	0.31	55	110	165	220	330	440
Yellow	574	-	0.447	0.488	95	190	285	380	570	760
Blue	467	-	0.14	0.061	40	80	120	160	240	320
Magenta	-	-	0.348	0.155	50	100	150	200	300	400
Cyan	490	-	0.146	0.308	110	220	330	440	660	880
Amber	589	-	0.542	0.417	80	160	240	320	480	640
Rose	-	-	0.486	0.217	50	100	150	200	300	400
Lime Green	562	-	0.376	0.538	110	220	330	440	660	880
Orange	599	-	0.605	0.371	70	140	210	280	420	560
Sky Blue	483	-	0.143	0.213	90	180	270	360	540	720
Violet	-	-	0.223	0.097	45	90	135	180	270	360
Spring Green	505	-	0.15	0.518	130	260	390	520	780	1040

## FCC Part 15 Class B

This equipment has been tested and found to comply with the limits for a Class B digital device, pursuant to part 15 of the FCC Rules. These limits are designed to provide reasonable protection against harmful interference in a residential installation. This equipment generates, uses and can radiate radio frequency energy and, if not installed and used in accordance with the instructions, may cause harmful interference to radio communications. However, there is no guarantee that interference will not occur in a particular installation. If this equipment does cause harmful interference to radio or television reception, which can be determined by turning the equipment off and on, the user is encouraged to try to correct the interference by one or more of the following measures:

- Reorient or relocate the receiving antenna.
- Increase the separation between the equipment and receiver.
- Connect the equipment into an outlet on a circuit different from that to which the receiver is connected.
- Consult the dealer or an experienced radio/TV technician for help.

<sup>(1)</sup> Refer to the CIE 1931 (x,y) Chromaticity Diagram to show equivalent color with indicated color coordinates. Actual coordinates may differ  $\pm 5\%$ .

<sup>(2)</sup> Lumen values shown apply to diffused models only. Heavy diffused models are 30% lower.

## Industry Canada ICES-003(B)

This device complies with CAN ICES-3 (B)/NMB-3(B). Operation is subject to the following two conditions: 1) This device may not cause harmful interference; and 2) This device must accept any interference received, including interference that may cause undesired operation.

Cet appareil est conforme à la norme NMB-3(B). Le fonctionnement est soumis aux deux conditions suivantes : (1) ce dispositif ne peut pas occasionner d'interférences, et (2) il doit tolérer toute interférence, y compris celles susceptibles de provoquer un fonctionnement non souhaité du dispositif.

## Dimensions

Dimensions are shown with the included SMBWLS28RA bracket.

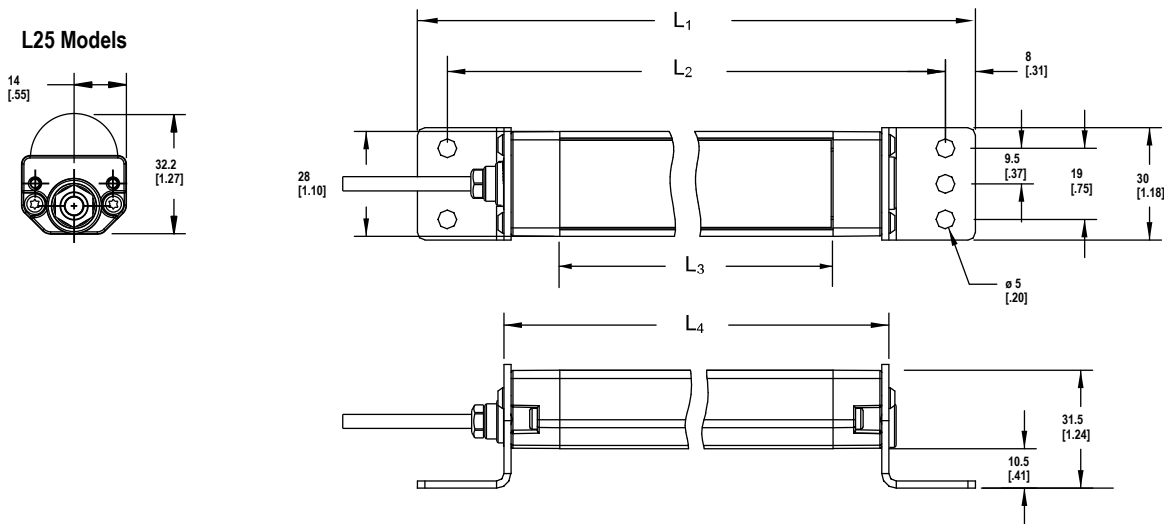

Models	L <sub>1</sub>	L <sub>2</sub>	L <sub>3</sub>	L <sub>4</sub>
WLS28..145..	221 mm (8.7 in)	205 mm (8.1 in)	145 mm (5.71 in)	175 mm (6.9 in)
WLS28..285..	362 mm (14.3 in)	346 mm (13.6 in)	286 mm (11.26 in)	316 mm (12.4 in)
WLS28..430..	503 mm (19.8 in)	487 mm (19.2 in)	427 mm (16.81 in)	457 mm (18.0 in)
WLS28..570..	644 mm (25.4 in)	628 mm (24.7 in)	568 mm (22.36 in)	598 mm (23.5 in)
WLS28..850..	926 mm (36.5 in)	910 mm (35.8 in)	850 mm (33.46 in)	880 mm (34.6 in)
WLS28..1130..	1208 mm (47.6 in)	1192 mm (46.9 in)	1132 mm (44.57 in)	1162 mm (45.7 in)

## Photometric Data

Photometric data shown below is for standard clear, and 25° clear window daylight white models only. To get lux and candela values for other colors, multiply the values shown on the charts by the following factors:

Incandescent White: 0.449	Red: 0.224	Rose: 0.204
Warm White: 0.449	Yellow: 0.388	Lime Green: 0.449
Fluorescent White: 0.837	Blue: 0.163	Orange: 0.286
Neutral White: 1.082	Magenta: 0.204	Sky Blue: 0.367
Cool White: 1.082	Cyan: 0.449	Violet: 0.184
Green: 0.592	Amber: 0.327	Spring Green: 0.531

For models with a standard diffused window, multiply lux and candela values by an additional 0.750. Photometric data for 25° diffused lensed models is not shown.

145 mm Models - Clear Window

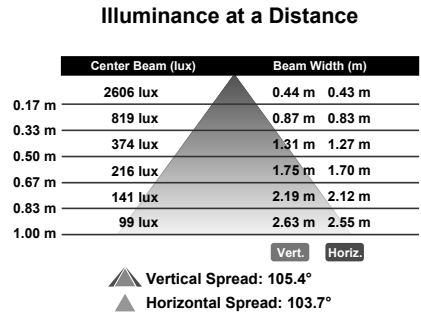
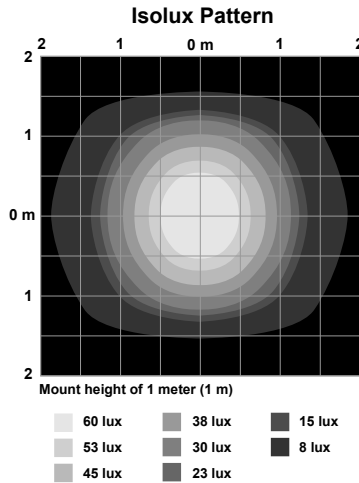
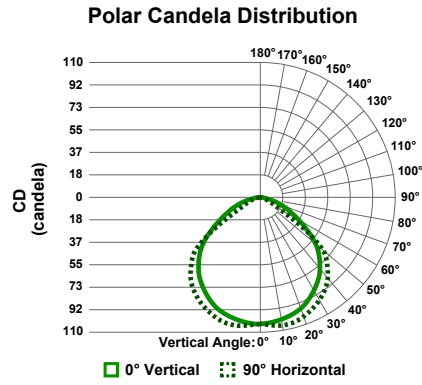

145 mm Models - L25 Window

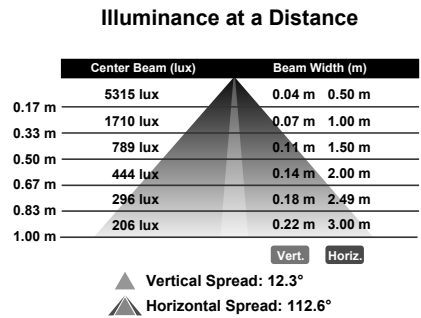
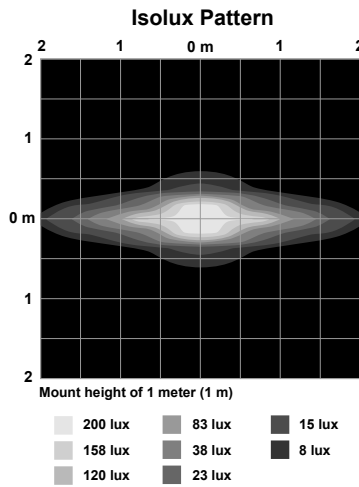
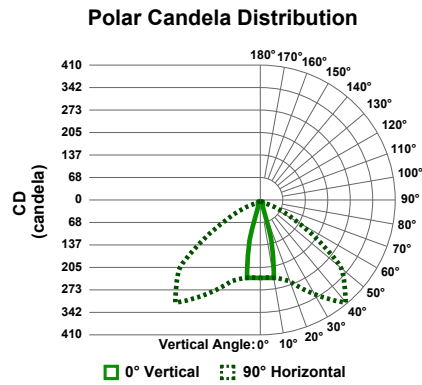

285 mm Models - Clear Window

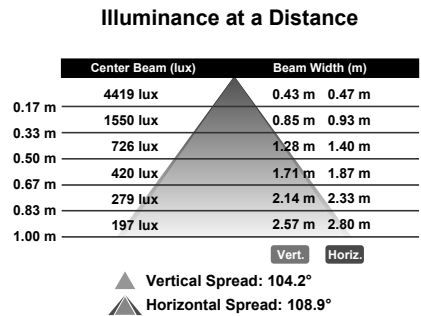
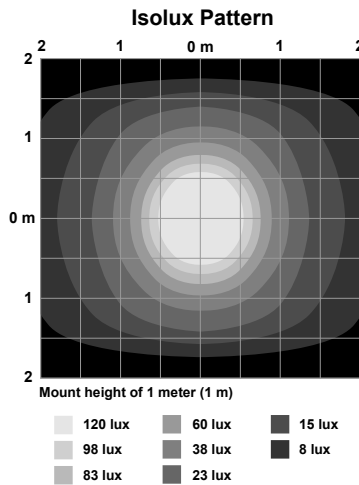
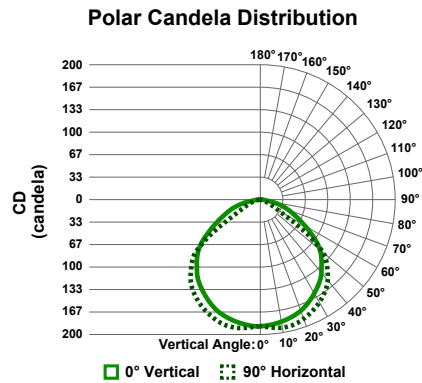

285 mm Models - L25 Window

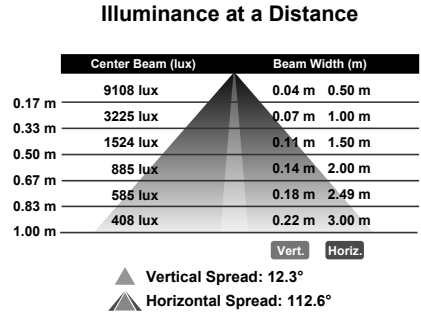
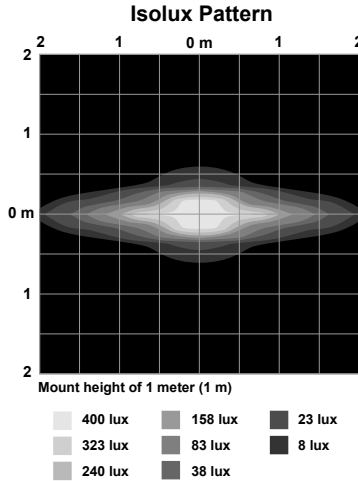
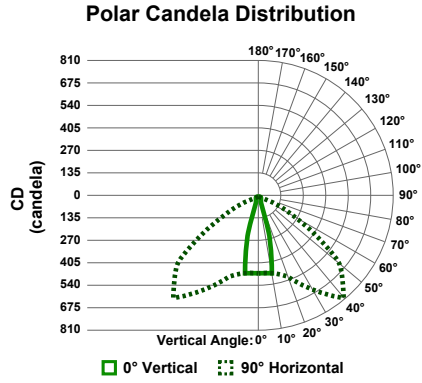

430 mm Models - Clear Window

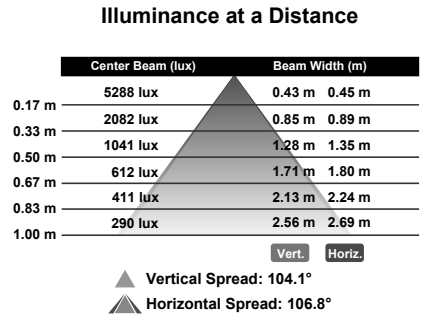
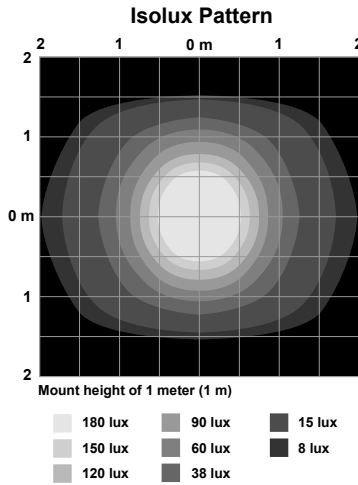
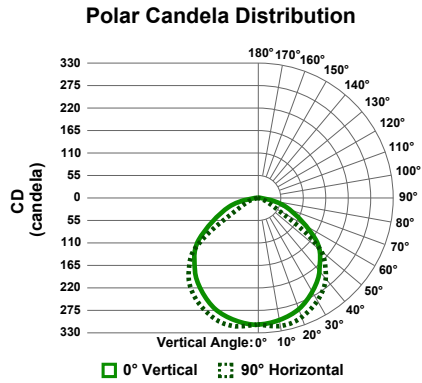

430 mm Models - L25 Window

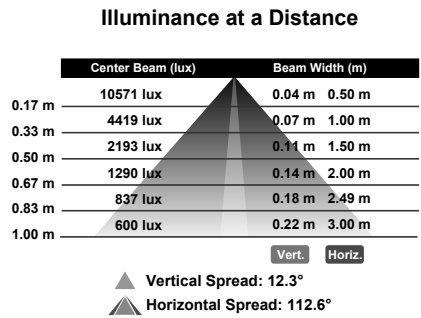
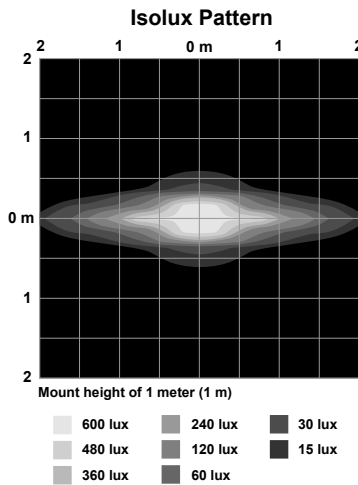
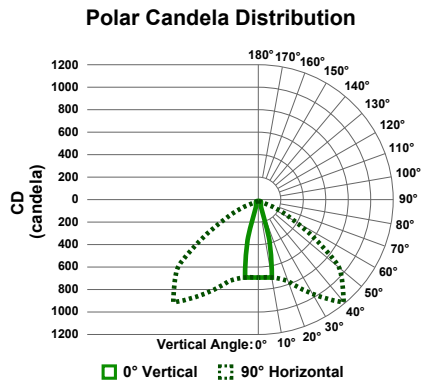

570 mm Models - Clear Window

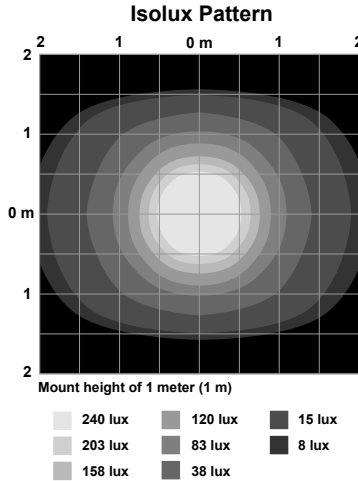
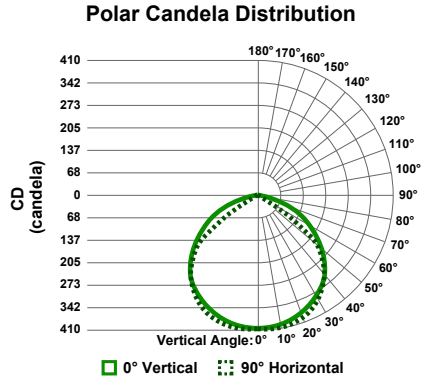

### Illuminance at a Distance

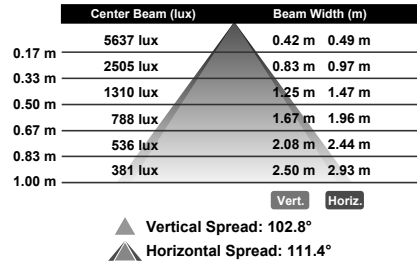

570 mm Models - L25 Window

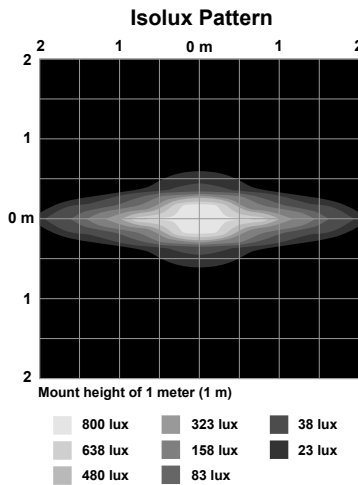
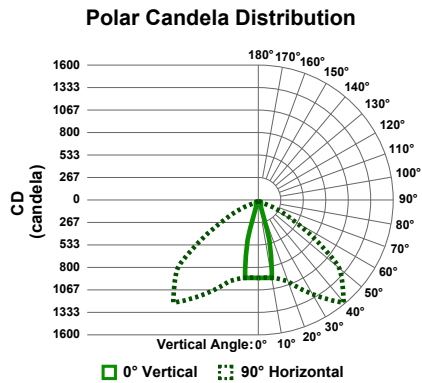

### Illuminance at a Distance

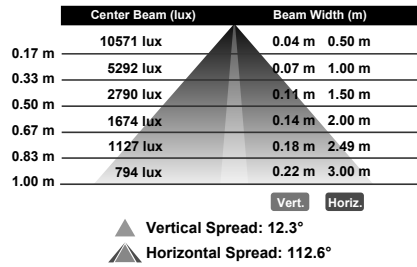

850 mm Models - Clear Window

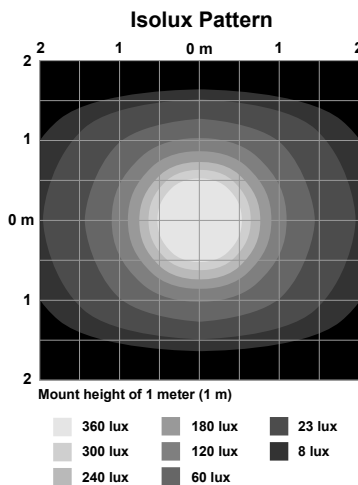
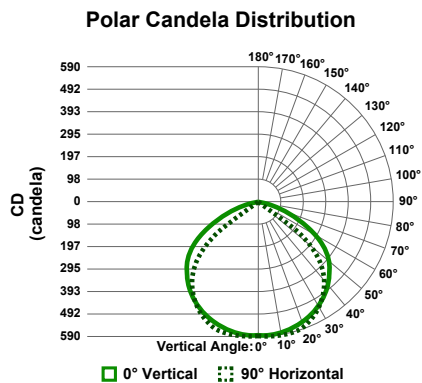

### Illuminance at a Distance

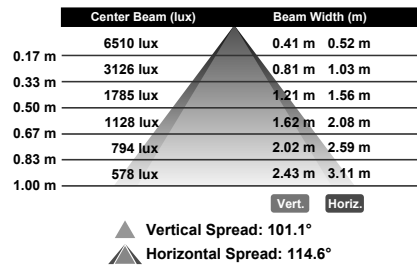

850 mm Models - L25 Window

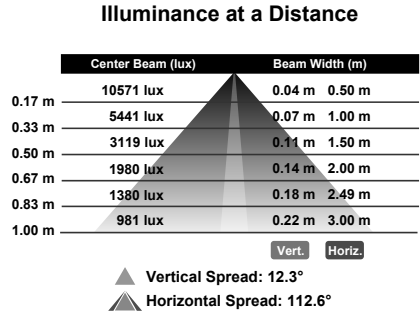
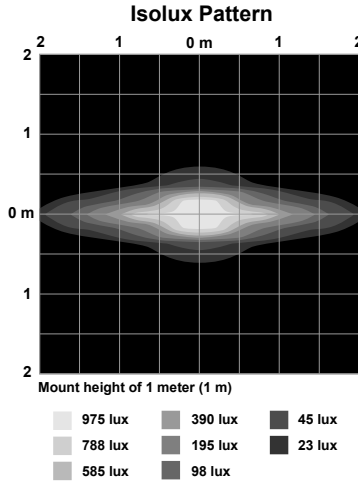
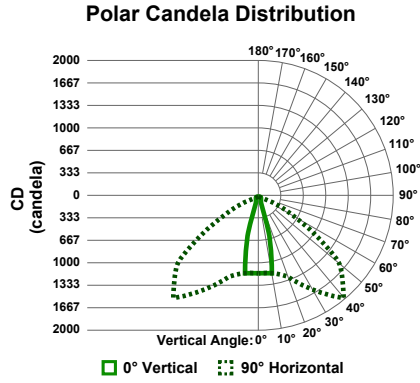

1130 mm Models - Clear Window

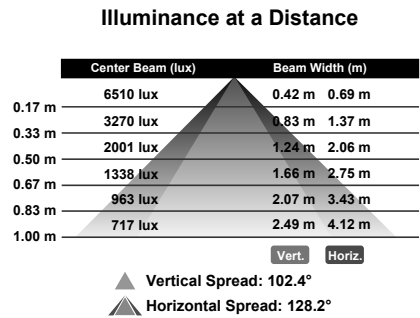
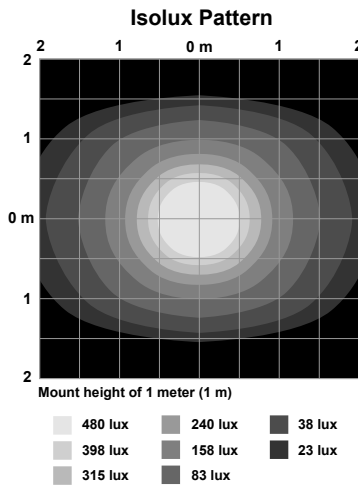
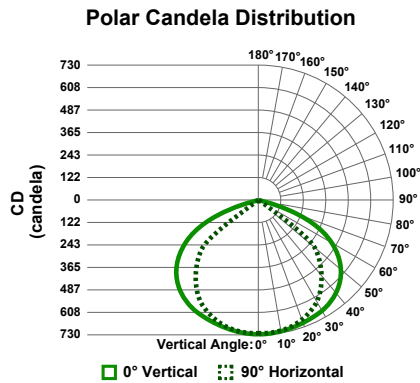

1130 mm Models - L25 Window

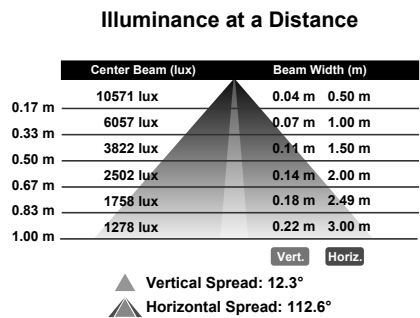
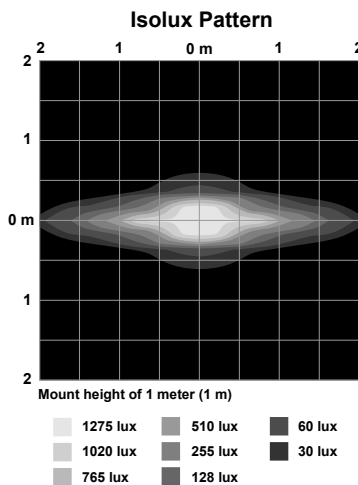
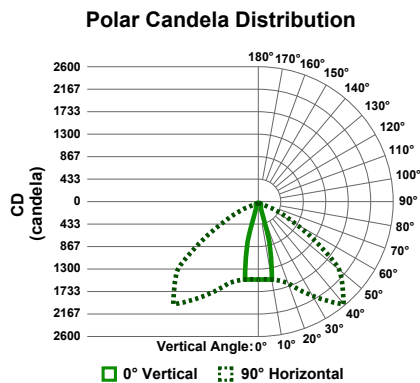

*Blank page*



Chapter Contents

Cordsets ..... 17  
 Brackets ..... 17

# Chapter 4 Accessories

## Cordsets

**CSB-M1251FM1251M**

- 5-pin parallel Y splitter (Male-Male-Female)
- For full Pro Editor preview capability
- Requires external power supply, sold separately

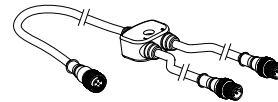

**PSD-24-4**

- 90 to 264 V AC 50/60 Hz input
- Includes a 1.8 m (6 ft) US style 5-15P input plug
- 24 V DC UL Listed Class 2 M12 connector output
- 4 A total current



4-Pin Threaded M12 Cordsets—Double Ended

Model	Length	Style	Dimensions	Pinout
MQDEC-401SS	0.31 m (1 ft)	Male Straight/ Female Straight		Female
MQDEC-403SS	0.91 m (2.99 ft)			
MQDEC-406SS	1.83 m (6 ft)			Male
MQDEC-412SS	3.66 m (12 ft)			
MQDEC-420SS	6.10 m (20 ft)			<p>1 = Brown 2 = White 3 = Blue 4 = Black</p>
MQDEC-430SS	9.14 m (30.2 ft)			
MQDEC-450SS	15.2 m (49.9 ft)			

## Brackets

**SMBWLS28RA**

The bracket kit is available as a replacement for the one that comes with the light or switch. The kit contains two end brackets and four screws.

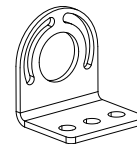

Continued on page 18

Continued from page 17

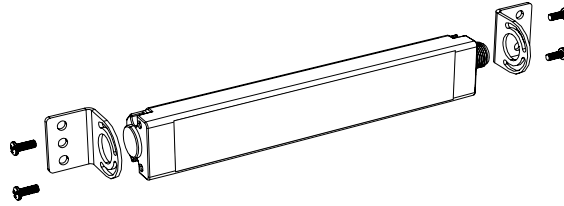

**SMBWLS28SM**

This kit allows the light or switch to be mounted at a right angle to the mounting surface. The kit contains two end brackets and four screws.

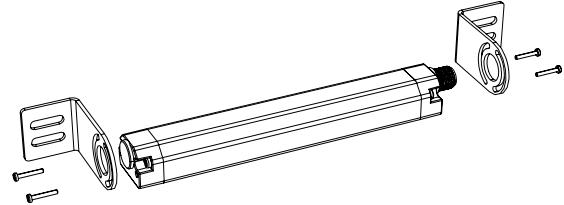

**SMBWLS28SP**

- Stainless steel snap bracket kit
- Includes two brackets

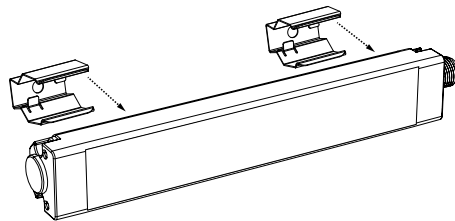
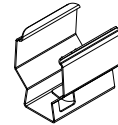

**SMH1316**

This kit allows the light or switch to be mounted to a 13/16-inch Unistrut channel. Light is shown. The kit includes:

- #10-32 spring nuts (qty 2)
- #10-32 socket head cap screws (qty 2)
- #10 lock washers (qty 2)

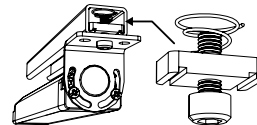

**SMBWLSMAG**

Magnetic mounting bracket for easy attachment to steel surfaces

**SMBWLSMAGR**

Protective cover also available to prevent scratches to painted surfaces

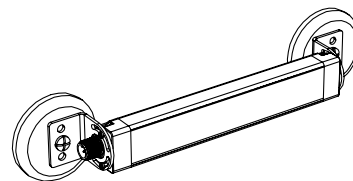

Chapter Contents

Mexican Importer..... 19

# Chapter 5 Banner Engineering Corp Limited Warranty

Banner Engineering Corp. warrants its products to be free from defects in material and workmanship for one year following the date of shipment. Banner Engineering Corp. will repair or replace, free of charge, any product of its manufacture which, at the time it is returned to the factory, is found to have been defective during the warranty period. This warranty does not cover damage or liability for misuse, abuse, or the improper application or installation of the Banner product.

**THIS LIMITED WARRANTY IS EXCLUSIVE AND IN LIEU OF ALL OTHER WARRANTIES WHETHER EXPRESS OR IMPLIED (INCLUDING, WITHOUT LIMITATION, ANY WARRANTY OF MERCHANTABILITY OR FITNESS FOR A PARTICULAR PURPOSE), AND WHETHER ARISING UNDER COURSE OF PERFORMANCE, COURSE OF DEALING OR TRADE USAGE.**

This Warranty is exclusive and limited to repair or, at the discretion of Banner Engineering Corp., replacement. **IN NO EVENT SHALL BANNER ENGINEERING CORP. BE LIABLE TO BUYER OR ANY OTHER PERSON OR ENTITY FOR ANY EXTRA COSTS, EXPENSES, LOSSES, LOSS OF PROFITS, OR ANY INCIDENTAL, CONSEQUENTIAL OR SPECIAL DAMAGES RESULTING FROM ANY PRODUCT DEFECT OR FROM THE USE OR INABILITY TO USE THE PRODUCT, WHETHER ARISING IN CONTRACT OR WARRANTY, STATUTE, TORT, STRICT LIABILITY, NEGLIGENCE, OR OTHERWISE.**

Banner Engineering Corp. reserves the right to change, modify or improve the design of the product without assuming any obligations or liabilities relating to any product previously manufactured by Banner Engineering Corp. Any misuse, abuse, or improper application or installation of this product or use of the product for personal protection applications when the product is identified as not intended for such purposes will void the product warranty. Any modifications to this product without prior express approval by Banner Engineering Corp will void the product warranties. All specifications published in this document are subject to change; Banner reserves the right to modify product specifications or update documentation at any time. Specifications and product information in English supersede that which is provided in any other language. For the most recent version of any documentation, refer to: [www.bannerengineering.com](http://www.bannerengineering.com).

For patent information, see [www.bannerengineering.com/patents](http://www.bannerengineering.com/patents).

## Mexican Importer

Banner Engineering de México, S. de R.L. de C.V. | David Alfaro Siqueiros 103 Piso 2 Valle oriente | San Pedro Garza Garcia Nuevo León, C. P. 66269

81 8363.2714

 [LinkedIn](#)

 [Twitter](#)

 [Facebook](#)

