

# Q5X Laser Triangulation Sensor with Analog Outputs



## Quick Start Guide

Laser sensor with an analog output and IO-Link

This guide is designed to help you set up and install the Q5X Laser Triangulation Sensor. For complete information on programming, performance, troubleshooting, dimensions, and accessories, please refer to the Instruction Manual at [www.bannerengineering.com](http://www.bannerengineering.com). Search for p/n 219602 to view the Instruction Manual. Use of this document assumes familiarity with pertinent industry standards and practices.



### WARNING:

- **Do not use this device for personnel protection**
- Using this device for personnel protection could result in serious injury or death.
- This device does not include the self-checking redundant circuitry necessary to allow its use in personnel safety applications. A device failure or malfunction can cause either an energized (on) or de-energized (off) output condition.

## Features

The Q5X has three major features.

Figure 1. Q5X Features



1. Two output indicators (amber)
2. Display
3. Buttons

## Display and Indicators

The display is a four-digit, seven-segment LED. Run mode is the primary view displayed.

For 1-PT, 2-PT, BGS, FGS, and DYN TEACH modes, the display shows the current distance to the target in centimeters. For Dual TEACH mode, the display shows the percentage matched to the taught reference surface. A display value of **9999** indicates the sensor has not been taught.

Figure 2. Display in Run Mode

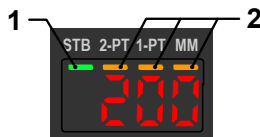

1. Stability Indicator (STB—Green)
2. Active TEACH Indicators
  - 2-PT - Two-Point TEACH (Amber)
  - 1-PT - One-Point TEACH (Amber)
3. Display value indicator (MM - Amber)

### Output Indicators

- Ch1: On when the displayed distance is within the taught analog output window
- Ch2: On when the displayed distance is within the taught discrete output window

### Stability Indicator (STB)

- On—Stable signal within the specified sensing range
- Flashing—Marginal signal, the target is outside the limits of the specified sensing range, or a multiple peak condition exists
- Off—No target detected within the specified sensing range

### Active TEACH Indicators (2PT and 1PT)

- 2-PT on—Two-point TEACH mode selected (default)
- 1-PT on—One-point TEACH mode selected

### Display Value Indicator (MM)

- On—Display shows the distance in millimeters (default)
- Off—Display shows the analog output value



## Buttons

Use the sensor buttons **(SELECT)**(TEACH), **(+)**(CH1/CH2), and **(-)**(MODE) to program the sensor.

Figure 3. Q5X sensor face

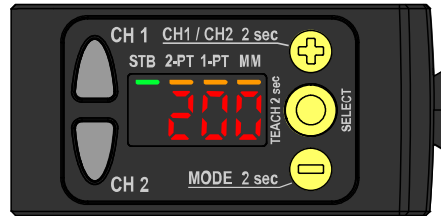

### **(SELECT)**(TEACH)

- Press to select menu items in Setup mode
- Press and hold for longer than 2 seconds to start the currently selected TEACH mode (the default is two-point TEACH)

### **(+)**(CH1/CH2)

- Press to navigate the sensor menu in Setup mode
- Press to change setting values; press and hold to increase numeric values
- Press and hold for longer than 2 seconds to switch between Channel 1 and Channel 2

### **(-)**(MODE)

- Press to navigate the sensor menu in Setup mode
- Press to change setting values; press and hold to decrease numeric values
- Press and hold for longer than 2 seconds to enter Setup mode



**Note:** When navigating the menu, the menu items loop.

## Class 2 Laser Description and Safety Information



### CAUTION:

- **Return defective units to the manufacturer.**
- Use of controls or adjustments or performance of procedures other than those specified herein may result in hazardous radiation exposure.
- Do not attempt to disassemble this sensor for repair. A defective unit must be returned to the manufacturer.



### CAUTION:

- **Never stare directly into the sensor lens.**
- Laser light can damage your eyes.
- Avoid placing any mirror-like object in the beam. Never use a mirror as a retroreflective target.



### For Safe Laser Use - Class 2 Lasers

- Do not stare at the laser.
- Do not point the laser at a person's eye.
- Mount open laser beam paths either above or below eye level, where practical.
- Terminate the beam emitted by the laser product at the end of its useful path.

Class 2 lasers are lasers that emit visible radiation in the wavelength range from 400 nm to 700 nm, where eye protection is normally afforded by aversion responses, including the blink reflex. This reaction may be expected to provide adequate protection under reasonably foreseeable conditions of operation, including the use of optical instruments for intrabeam viewing.

Low-power lasers are, by definition, incapable of causing eye injury within the duration of a blink (aversion response) of 0.25 seconds. They also must emit only visible wavelengths (400 to 700 nm). Therefore, an ocular hazard may exist only if individuals overcome their natural aversion to bright light and stare directly into the laser beam.

### Class 2 Red Laser models: Reference IEC 60825-1:2014

Figure 4. FDA (CDRH) warning label (Class 2)



**Output:** < 1.0 mW

**Laser wavelength:** 640 to 670 nm

**Pulse Duration:** 20  $\mu$ s to 2 ms

## Installation

### Sensor Orientation

Optimize detection reliability and minimum object separation performance with correct sensor-to-target orientation. To ensure reliable detection, orient the sensor as shown in relation to the target to be detected.

Figure 5. Optimal Orientation of Target to Sensor

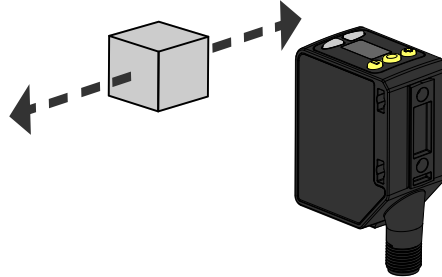

See the following figures for examples of correct and incorrect sensor-to-target orientation as certain placements may pose problems for sensing some targets. The Q5X can be used in the less preferred orientation and at steep angles of incidence and still provide reliable detection performance due to its high excess gain. For the minimum object separation distance required for each case, refer to .

Figure 6. Orientation by a wall

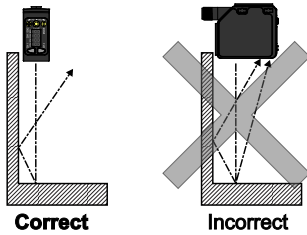

Figure 7. Orientation for a moving object

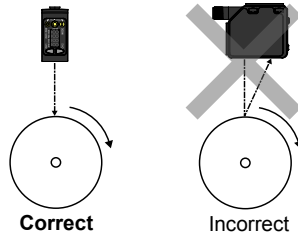

Figure 8. Orientation for a height difference

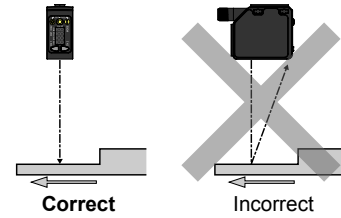

Figure 9. Orientation for a color or luster difference

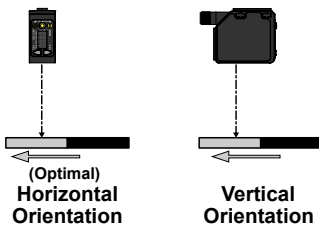
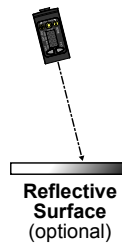

Figure 10. Orientation for highly reflective target <sup>¶</sup>



### Mount the Device

1. If a bracket is needed, mount the device onto the bracket.
2. Mount the device (or the device and the bracket) to the machine or equipment at the desired location. Do not tighten the mounting screws at this time.
3. Check the device alignment.
4. Tighten the mounting screws to secure the device (or the device and the bracket) in the aligned position.

<sup>¶</sup> Applying tilt to sensor may improve performance on reflective targets. The direction and magnitude of the tilt depends on the application, but a 15° tilt is often sufficient.

## Wiring Diagrams

Figure 11. Wiring diagram for 4-20mA Analog

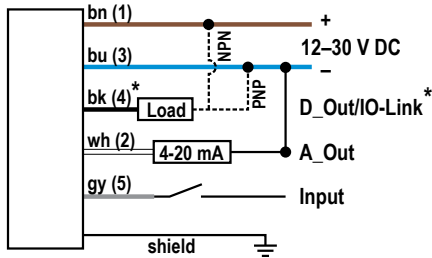

\* Push-Pull output. User-configurable PNP/NPN setting.

Figure 12. Wiring diagram for 0-10V Analog

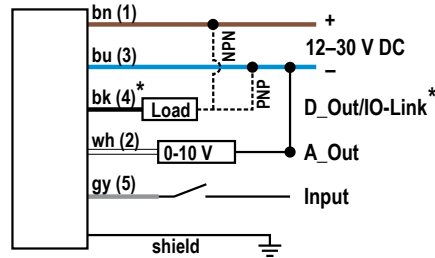

\* Push-Pull output. User-configurable PNP/NPN setting.

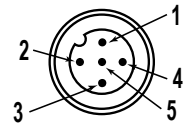

## Cleaning and Maintenance

Clean the sensor when soiled and use with care.

Handle the sensor with care during installation and operation. Sensor windows soiled by fingerprints, dust, water, oil, etc. may create stray light that may degrade the peak performance of the sensor. Blow the window clear using filtered, compressed air, then clean as necessary using only water and a lint-free cloth.

## Button Map from RSD1 to Sensor

The sensor may be optionally connected to the Banner RSD1 remote display accessory. Refer to this table for the RSD1 button association with your sensor.

Table 1: Button association between the RSD1 and the Q4X/Q5X sensors

Device	Up Button	Down Button	Enter Button	Escape Button
RSD1				
Q4X and Q5X				N/A

## Sensor Programming

Program the sensor using the buttons on the sensor or the remote input (limited programming options).

In addition to programming the sensor, use the remote input to disable the buttons for security, preventing unauthorized or accidental programming changes. See the Instruction Manual, p/n 219602 for more information.

## Setup Mode

Access Setup mode and the sensor menu from Run mode by pressing and holding **MODE** for longer than 2 seconds. Use and to navigate through the menu. Press **SELECT** to select a menu option and access the submenus. Use and to navigate through the submenus. Press **SELECT** to select a submenu option and return to the top menu, or press and hold **SELECT** for longer than 2 seconds to select a submenu option and return immediately to Run mode.

To exit Setup mode and return to Run mode, navigate to **End** and press **SELECT**.



**Note:** The number that follows a menu option, for example **ech 1**, indicates the channel that is selected. For menu items without a number (excluding submenu items), these menu options are only available from Channel 1 and the settings apply to both channels.

Figure 13. Sensor Menu Map—Channel 1

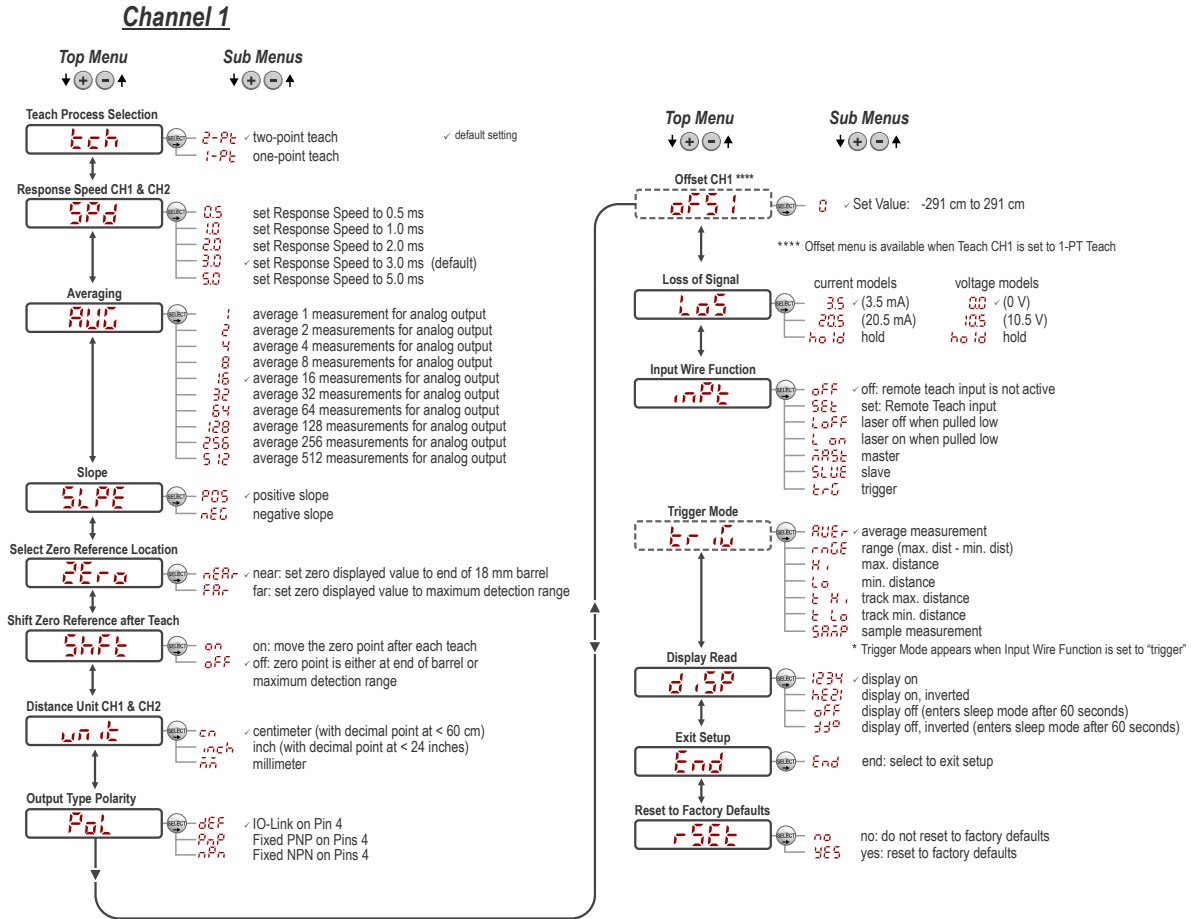
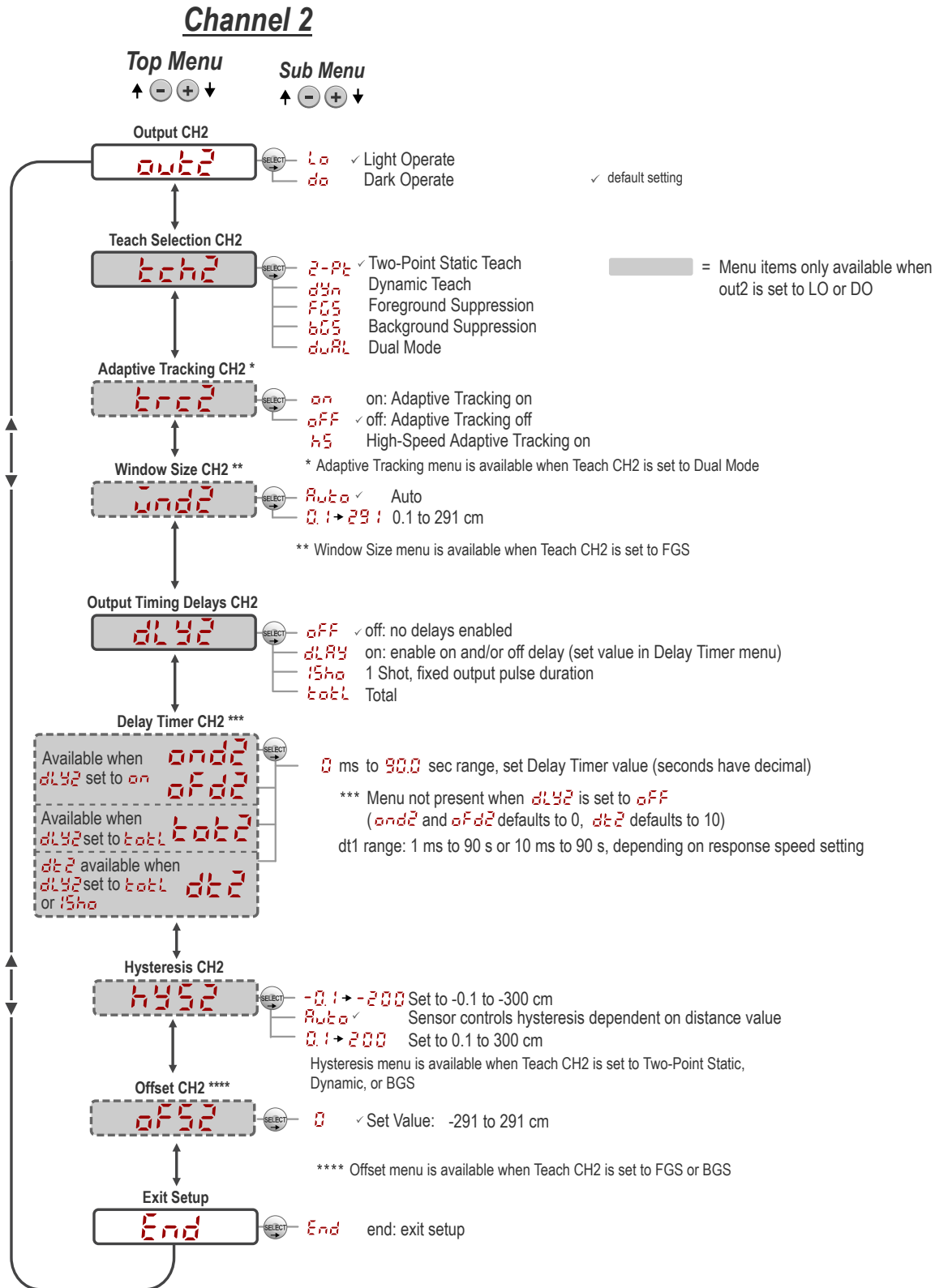

Figure 14. Sensor Menu Map—Channel 2



## Basic TEACH Instructions

Use the following instructions to teach the Q5X sensor. The instructions provided on the sensor display vary depending on the type of TEACH mode selected. Two-point TEACH is the default TEACH mode.

1. Press and hold **TEACH** for longer than 2 seconds to start the selected TEACH mode.
2. Present the target.
3. Press **TEACH** to teach the target. The target is taught and the sensor waits for the second target, if required by the selected TEACH mode, or returns to Run mode.
4. Complete these steps only if it is required for the selected TEACH mode.
  - a) Present the second target.
  - b) Press **TEACH** to teach the target. The target is taught and the sensor returns to Run mode.

See the Instruction Manual for detailed instructions and other available TEACH modes. The TEACH modes include:

- Two point analog teach **2-PT** —Sets the distance values associated with 0V and 10V (4mA and 20mA) based on taught target distances
- One point analog teach **1-PT** —Sets the 5V (12mA) midpoint of the analog output to center the analog output around a reference target position
- Two-point static background suppression **2-PT** (discrete, channel 2 only)—Two-point TEACH sets a single switch point. The sensor sets the switch point between two taught target distances.
- Dynamic background suppression **dyn** (discrete, channel 2 only)—Dynamic TEACH sets a single switch point during machine run conditions. The sensor takes multiple samples and the switch point is set between the minimum and the maximum sampled distances.
- One-point window (foreground suppression) **FGS** (discrete, channel 2 only)—One-point window sets a window (two switch points) centered around the taught target distance.
- One-point background suppression **BGS** (discrete, channel 2 only)—One-point background suppression sets a single switch point in front of the taught target distance. Objects beyond the taught switch point are ignored.
- Dual intensity + distance **dual** (discrete, channel 2 only)—Dual mode records the distance and amount of light received from the reference surface. See [Dual Mode Reference Surface Considerations](#) on page 11 for more information about selecting a reference surface. The output switches when an object passing between the sensor and the reference surface changes the perceived distance or amount of returned light.

## Manual Adjustments

Manually adjust the sensor switch point using the **+** and **-** buttons.

1. From Run mode, press either **+** or **-** one time.  
The selected channel displays briefly, then the current switch point value flashes slowly.
2. Press **+** to move the switch point up or **-** to move the switch point down.  
After 1 second of inactivity, the new switch point value flashes rapidly, the new setting is accepted, and the sensor returns to Run mode.



**Note:** When FGS mode is selected, manual adjustment moves both sides of the symmetrical threshold window simultaneously, expanding and collapsing the window size. Manual adjustment does not move the center point of the window.



**Note:** When dual mode is selected, after the TEACH process is completed, use the manual adjustment to adjust the sensitivity of the thresholds around the taught reference point. The taught reference point is a combination of the measured distance and returned signal intensity from the reference target. Manual adjustment does not move the taught reference point, but pressing **+** increases the sensitivity, and pressing **-** decreases the sensitivity. When re-positioning the sensor or changing the reference target, re-teach the sensor.

## Locking and Unlocking the Sensor Buttons

Use the lock and unlock feature to prevent unauthorized or accidental programming changes.

Three settings are available:

- **wLoc** —The sensor is unlocked and all settings can be modified (default).
- **Lac** — The sensor is locked and no changes can be made.
- **OLoc** —The switch point value can be changed by teaching or manual adjustment, but no sensor settings can be changed through the menu.



**Note:** When the sensor is in either **Lac** or **OLoc** mode, the active channel can be changed using **(+)(CH1/CH2)**.

When in **Loc** mode, **Loc** displays when the **(SELECT)(TEACH)** button is pressed. The switch point displays when **(+)(CH1/CH2)** or **(-)(MODE)** are pressed, but **Loc** displays if the buttons are pressed and held.

When in **OLoc** mode, **Loc** displays when **(-)(MODE)** is pressed and held. To access the manual adjust options, briefly press and release **(+)(CH1/CH2)** or **(-)(MODE)**. To enter TEACH mode, press the **(SELECT)(TEACH)** button and hold for longer than 2 seconds.

To enter **Loc** mode, hold **+** and press **-** four times. To enter **OLoc** mode, hold **+** and press **-** seven times. Holding **+** and pressing **-** four times unlocks the sensor from either lock mode and the sensor displays **wLoc**.

## Averaging **AUG**

Use this menu to set the number of measurements that are averaged together for the analog output.

Increasing the averaging improves repeatability, but increases the total response speed. The default is 16. The filter can be set to 1, 2, 4, 8, 16, 32, 64, 128, 256, or 512. Use the table to determine the total response speed.

Table 2: Response Speed (ms)

Base Measurement Rate	Filter Setting									
	1	2	4	8	16	32	64	128	256	512
0.5 ms	0.5	1.5	3	7	13	26	50	100	200	400
1.0 ms	1	3	5	11	20	45	90	160	320	650
2.0 ms	3	5	9	20	40	80	150	300	600	1200
3.0 ms	5	8	15	30	55	110	220	420	840	1680
5.0 ms	10	15	25	45	85	170	340	680	1350	2270

Figure 15. Lateral entry to the Q5X

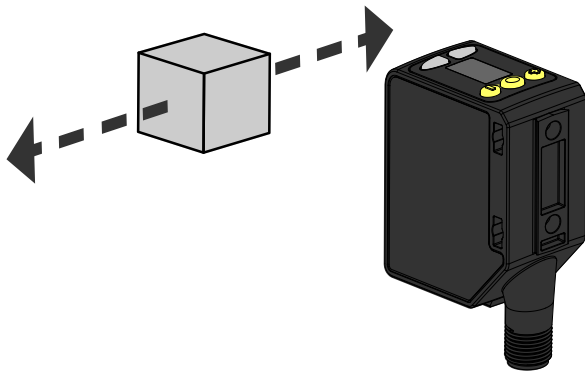

Table 3: Lateral Entry Response

Base Measurement Rate (ms)	Lateral Entry Response (ms)
0.5	3
1.0	5
2.0	15
3.0	25
5.0	50

When lateral entry needs to be considered, the lateral entry response is added to calculate the total response time.



**Note:** The Q5X uses a dynamic measurement rate, so these response times are worst-case.



## Specifications

### Sensing Beam

IEC 60825-1:2014  
Visible red Class 2 laser models, 650 nm

### Supply Voltage (Vcc)

12 to 30 V DC (Class 2 supply) (10% max ripple within limits)

### Supply Protection Circuitry

Protected against reverse polarity and transient overvoltages

### Power and Current Consumption, exclusive of load

< 1 W

### Sensing Range

95 mm to 3000 mm (3.74 in to 118.11 in)

### Output Configuration

Channel 1: Analog output  
Channel 2: Configurable PNP/NPN discrete output or IO-Link

### Discrete Output Rating

Current rating: 50 mA maximum

Black wire specifications per configuration	
IO-Link Push/Pull	Output High: $\geq V_{\text{supply}} - 2.5 \text{ V}$
	Output Low: $\leq 2.5 \text{ V}$
PNP	Output High: $\geq V_{\text{supply}} - 2.5 \text{ V}$
	Output Low: $\leq 1 \text{ V}$ (loads $\leq 1 \text{ Meg}\Omega$ )
NPN	Output High: $\geq V_{\text{supply}} - 2.5 \text{ V}$ (loads $\leq 50 \text{ k}\Omega$ )
	Output Low: $\leq 2.5 \text{ V}$

White wire specifications per configuration	
Q5XKU... models	0–10 V DC, 1000 Ohm minimum
Q5XKI... models	4–20 mA DC, 300 Ohm maximum

### Beam Spot Size

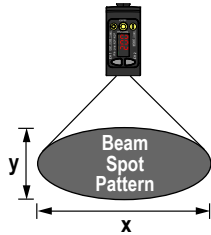

Distance (mm)	Size (x × y) (mm)
100	2.6 × 1.5
1000	4.2 × 2.5
2000	6 × 3.6
2000 to 3000	7.8 × 4.7

Beam spot size is calculated as 1.6 times the D4σ measured value

### Boresighting

± 65 mm at 3000 mm

### Response Speed

Total response speed varies between 0.5 ms and 2270 ms, depending on base measurement rate and averaging settings.  
For more information, see [Averaging](#) on page 8.

### Delay at Power Up

< 2.5 s

### Maximum Torque

Side mounting: 1 N·m (9 in·lbs)

### Ambient Light Immunity

5000 lux at 1 m  
2000 lux at 2 m

### Connector

Integral 5-pin M12 male quick-disconnect connector

### Construction

Housing: ABS  
Lens cover: PMMA acrylic  
Lightpipe and display window: polycarbonate

### Temperature Effect (Typical)

< 0.5 mm/°C at < 500 mm  
< 1.0 mm/°C at < 1000 mm  
< 2.0 mm/°C at < 2000 mm  
< 5.0 mm/°C at < 3000mm

### Output Distance Repeatability

Distance (mm)	Repeatability
95 to 300	± 0.5 mm
300 to 1000	± 0.25%
1000 to 2000	± 0.5%
2000 to 3000	± 1.0%

### Remote Input

Allowable Input Voltage Range: 0 to Vsupply  
Active High (internal weak pull-down): High state > (Vsupply – 2.25 V) at 2 mA maximum  
Active Low (internal weak pull-up): Low state < 2.25 V at 2 mA maximum

### IO-Link Interface

IO Link Revision V1.1  
Smart Sensor Profile: Yes  
Baud Rate: 38400 bps  
Process Data In Length: 32 bits  
Process Data Out Length: 8 bits  
Minimum Cycle Time: 3.6 ms  
IODD files: Provides all programming options of the display, plus additional functionality.

### Application Note

For optimum performance, allow 10 minutes for the sensor to warm up

### Environmental Rating

IP67 per IEC60529

### Vibration

MIL-STD-202G, Method 201A (Vibration: 10 Hz to 55 Hz, 0.06 inch (1.52 mm) double amplitude, 2 hours each along X, Y and Z axes), with device operating

**Required Overcurrent Protection**



**WARNING:** Electrical connections must be made by qualified personnel in accordance with local and national electrical codes and regulations.

Overcurrent protection is required to be provided by end product application per the supplied table.  
 Overcurrent protection may be provided with external fusing or via Current Limiting, Class 2 Power Supply.  
 Supply wiring leads < 24 AWG shall not be spliced.  
 For additional product support, go to [www.bannerengineering.com](http://www.bannerengineering.com).

Supply Wiring (AWG)	Required Overcurrent Protection (Amps)
20	5.0
22	3.0
24	2.0
26	1.0
28	0.8
30	0.5

**Shock**

MIL-STD-202G, Method 213B, Condition I (100G 6x along X, Y, and Z axes, 18 shocks), with device operating

**Operating Conditions**

-10 °C to +50 °C (+14 °F to +122 °F)  
 35% to 95% relative humidity

**Storage Temperature**

-25 °C to +70 °C (-13 °F to +158 °F)

**Certifications**



**Banner Engineering Europe** Park Lane, Culliganlaan  
 2F bus 3, 1831 Diegem, BELGIUM



**Turck Banner LTD** Blenheim House, Blenheim Court,  
 Wickford, Essex SS11 8YT, Great Britain



Industrial  
 Control  
 Equipment  
 LISTED 3TJJ

Class 2 power  
 UL Environmental Rating: Type 1

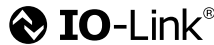

**Excess Gain**

Base Measurement Rate (ms)	Base Measurement Rate in Sync Mode (ms)	Ambient Light Rejection	Excess Gain (90% White Card)				
			at 100 mm	at 500 mm	at 1000 mm	at 2000 mm	at 3000 mm
0.5	1.0	Disabled	200	80	25	6	3
1.0	2.0	Enabled	200	80	25	6	3
2.0	4.0	Enabled	920	400	100	25	12
3.0	6.0	Enabled	1600	700	200	50	25
5.0	10.0	Enabled	3200	1400	400	100	50

**FCC Part 15**

This device complies with Part 15 of the FCC Rules. This equipment generates, uses, and can radiate radio frequency energy and, if not installed and used in accordance with the instruction manual, may cause harmful interference to radio communications. Operation is subject to the following two conditions: 1) This device may not cause harmful interference; and 2) This device must accept any interference received, including interference that may cause undesired operation.

**Industry Canada**

This device complies with CAN ICES-3 (A)/NMB-3(A). Operation is subject to the following two conditions: 1) This device may not cause harmful interference; and 2) This device must accept any interference received, including interference that may cause undesired operation.

Cet appareil est conforme à la norme NMB-3(A). Le fonctionnement est soumis aux deux conditions suivantes : (1) ce dispositif ne peut pas occasionner d'interférences, et (2) il doit tolérer toute interférence, y compris celles susceptibles de provoquer un fonctionnement non souhaité du dispositif.

**Performance Curves**

Figure 16. Minimum Object Separation Distance (90% to 6% reflectance) for the 3000 mm Models

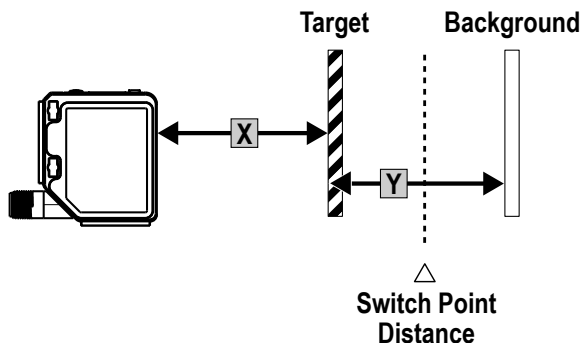

Figure 17. Discrete Minimum Object Separation (Uniform and Non-Uniform)

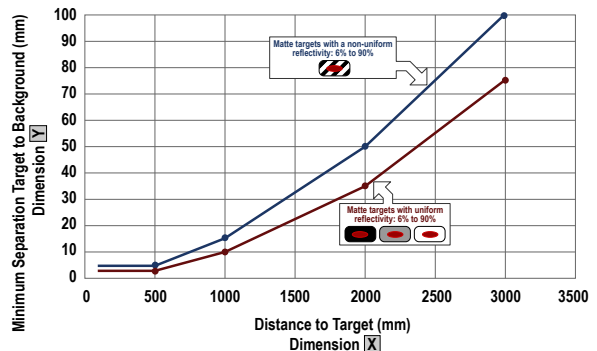

Figure 18. Accuracy (90% to 6% Reflectance)

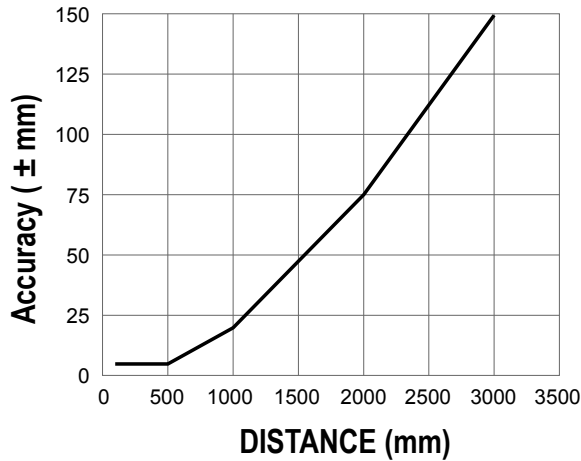

Figure 19. Repeatability (90% to 6% Reflectance)

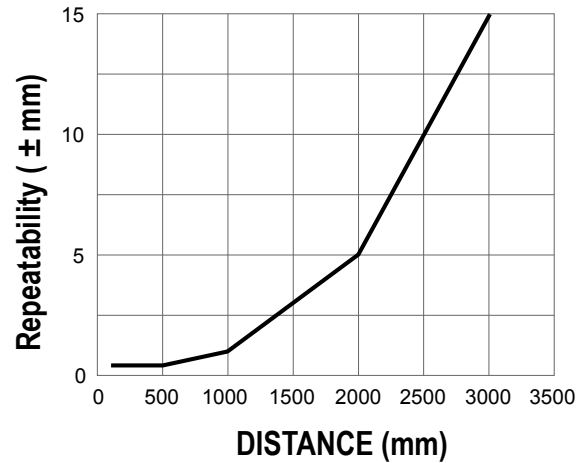
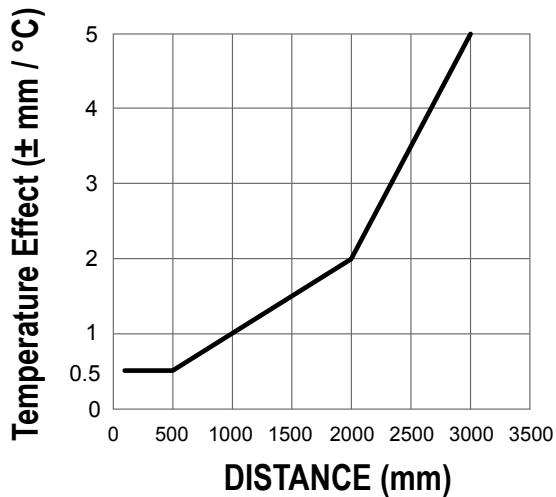

Figure 20. Temperature Effects (90% to 6% Reflectance)



## Dual Mode Reference Surface Considerations

Optimize reliable detection by applying these principles when selecting your reference surface, positioning your sensor relative to the reference surface, and presenting your target.

The robust detection capabilities of the Q5X allows successful detection even under non-ideal conditions in many cases. Typical reference surfaces are metal machine frames, conveyor side rails, or mounted plastic targets. Contact Banner Engineering if you require assistance setting up a stable reference surface in your application.

For detailed instructions for detecting clear or transparent objects, refer to the Instruction Manual, p/n 219602.

1. Select a reference surface with these characteristics where possible:
  - Matte or diffuse surface finish
  - Fixed surface with no vibration
  - Dry surface with no build-up of oil, water, or dust
2. Position the reference surface between 200 mm (20 cm) and the maximum sensing range.
3. Position the target to be detected as close to the sensor as possible, and as far away from the reference surface as possible.
4. Angle the sensing beam relative to the target and relative to the reference surface 10 degrees or more.

## Banner Engineering Corp. Limited Warranty

---

Banner Engineering Corp. warrants its products to be free from defects in material and workmanship for one year following the date of shipment. Banner Engineering Corp. will repair or replace, free of charge, any product of its manufacture which, at the time it is returned to the factory, is found to have been defective during the warranty period. This warranty does not cover damage or liability for misuse, abuse, or the improper application or installation of the Banner product.

**THIS LIMITED WARRANTY IS EXCLUSIVE AND IN LIEU OF ALL OTHER WARRANTIES WHETHER EXPRESS OR IMPLIED (INCLUDING, WITHOUT LIMITATION, ANY WARRANTY OF MERCHANTABILITY OR FITNESS FOR A PARTICULAR PURPOSE), AND WHETHER ARISING UNDER COURSE OF PERFORMANCE, COURSE OF DEALING OR TRADE USAGE.**

This Warranty is exclusive and limited to repair or, at the discretion of Banner Engineering Corp., replacement. **IN NO EVENT SHALL BANNER ENGINEERING CORP. BE LIABLE TO BUYER OR ANY OTHER PERSON OR ENTITY FOR ANY EXTRA COSTS, EXPENSES, LOSSES, LOSS OF PROFITS, OR ANY INCIDENTAL, CONSEQUENTIAL OR SPECIAL DAMAGES RESULTING FROM ANY PRODUCT DEFECT OR FROM THE USE OR INABILITY TO USE THE PRODUCT, WHETHER ARISING IN CONTRACT OR WARRANTY, STATUTE, TORT, STRICT LIABILITY, NEGLIGENCE, OR OTHERWISE.**

Banner Engineering Corp. reserves the right to change, modify or improve the design of the product without assuming any obligations or liabilities relating to any product previously manufactured by Banner Engineering Corp. Any misuse, abuse, or improper application or installation of this product or use of the product for personal protection applications when the product is identified as not intended for such purposes will void the product warranty. Any modifications to this product without prior express approval by Banner Engineering Corp will void the product warranties. All specifications published in this document are subject to change; Banner reserves the right to modify product specifications or update documentation at any time. Specifications and product information in English supersede that which is provided in any other language. For the most recent version of any documentation, refer to:

[www.bannerengineering.com](http://www.bannerengineering.com).

For patent information, see [www.bannerengineering.com/patents](http://www.bannerengineering.com/patents).



more sensors, more solutions