

WLS27 Segmented LED Strip Light



Datasheet

Banner's WLS27 Segmented LED Strip Light has a sturdy aluminum housing and is encased in a shatterproof, UV-stabilized, copolyester shell, making it ideal for harsh indoor and outdoor applications.

- Ultra-bright, multi-segment indicator
- Models with 2 or 3 segments available in two different segment sizes
- Rugged, water-resistant IP69K per DIN 40050-9 rating
- Four available lengths: 285 mm, 430 mm, 570 mm, or 850 mm
- Daisy chain power to multiple lights
- Heavy diffused housing option provides softer, more uniform light

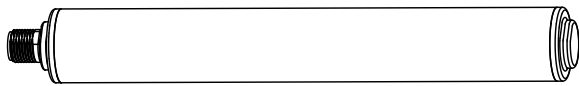

Figure 1. Stand-alone light or end light in a cascade



Figure 2. First or middle of a cascade

Available as stand-alone models, or as cascade models that can be daisy-chained together for a continuous length of lighting, with a minimum of wiring. Stand-alone models have a male quick disconnect at one end for power connection and no connections at the opposite end. A stand-alone model may be used as the last model in the cascade series. Cascade models have a male quick disconnect at one end for power connection and a female quick disconnect at the opposite end for connecting to other lights in the cascade. A double-ended accessory cordset must be used between each pair of lights in a cascade.



Important: Lea el siguiente instructivo antes de operar el luminario. Por favor descargue desde www.bannerengineering.com toda la documentación técnica de los WLS27 Segmented LED Strip Light, disponibles en múltiples idiomas, para detalles del uso adecuado, aplicaciones, advertencias, y las instrucciones de instalación de estos dispositivos.



Important: Lisez les instructions suivantes avant d'utiliser le luminaire. Veuillez télécharger la documentation technique complète des WLS27 Segmented LED Strip Light sur notre site www.bannerengineering.com pour les détails sur leur utilisation correcte, les applications, les notes de sécurité et les instructions de montage.

Models

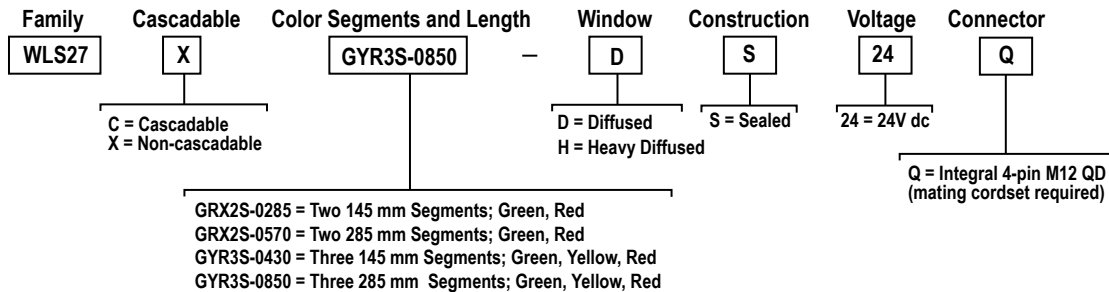

Wiring Diagrams

Male	Female	Pin	Wire Color	Description
		1	Brown	Input 1
		2	White	Input 3
		3	Blue	dc common
		4	Black	Input 2



3 Segment Strip Lights			
Input 1: Pin 1 Brown Wire	Input 2: Pin 4 Black Wire	Input 3: Pin 2 White Wire	LED Color
-	-	-	Light OFF
+24 V dc	-	-	Segment 1 ON
-	+24 V dc	-	Segment 2 ON
+24 V dc	+24 V dc	-	Segment 1 and 2 ON
-	-	+24 V dc	Segment 3 ON
+24 V dc	-	+24 V dc	Segment 1 and 3 ON
-	+24 V dc	+24 V dc	Segment 2 and 3 ON
+24 V dc	+24 V dc	+24 V dc	Segment 1, 2, and 3 ON

2 Segment Strip Lights		
Input 1: Pin 1 Brown Wire	Input 2: Pin 4 Black Wire	LED Color
-	-	Light OFF
+24 V dc	-	Segment 1 ON
-	+24 V dc	Segment 2 ON
+24 V dc	+24 V dc	Segment 1 and 2 ON

Specifications

Supply Voltage

24 V dc (+ 20% / - 10%)
 Use only with suitable Class 2 power supply (UL) or a SELV power supply (CE)
 See electrical characteristics on product label

Lighted Length	Segments	Typical Current (A) at 25° C per Segment [†]	Typical Current (A) at 25 °C for all Segments	Maximum Current (A)
285 mm	2	0.155	0.360	0.4
430 mm	3	0.155	0.540	0.6
570 mm	2	0.315	0.630	0.8
850 mm	3	0.315	0.945	1.2

Supply Protection Circuitry

Protected against reverse polarity and transient voltages

Application Notes

When connecting cascadable lights in series it is important not to exceed maximum current limitations: Maximum length of light at 24 V dc: 3.0 m (9.8 ft)
 Do not spray cable with high-pressure sprayer or cable damage will result.

Light Characteristics

Color	Dominant Wavelength (nm) or Color Temperature	Lighted Length Lumens (Typical at 25 °C) [†]	
		285 and 430 mm	570 and 850 mm
Green	525 nm	150	400
Yellow	580 nm	215	570
Red	625 nm	70	185

Mounting

Bracket **LMBWLS27EC** included (2 for lights up to 570 mm or 3 for 850 mm lights)

Connections

Integral 4-pin M12/Euro-style male quick disconnect

Construction

Clear anodized aluminum inner housing and FDA-grade copolyester outer housing

Environmental Rating

IEC IP66, IEC IP67, and IP69K per DIN 40050-9

Vibration and Mechanical Shock

Vibration: 10 Hz to 55 Hz, 1.0 mm peak-to-peak amplitude per IEC 60068-2-6
 Shock: 15G 11 ms duration, half sine wave per IEC 60068-2-27

Operating Temperature

-40 °C to +50 °C (-40 °F to +122 °F)

Storage Temperature: -40 °C to +70 °C (-40 °F to +158 °F)

Certifications



Dimensions

All measurements are listed in millimeters, unless noted otherwise.

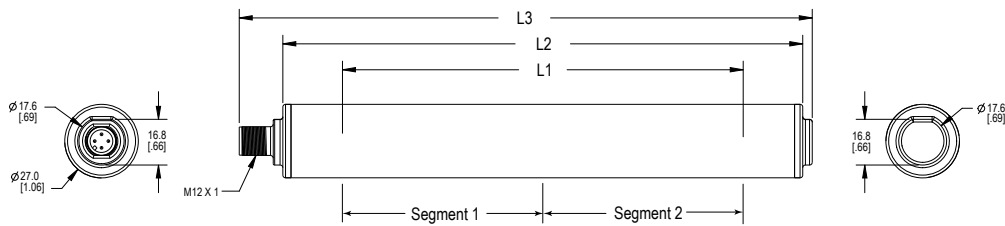

Figure 3. Non-cascade models, two segment example model shown

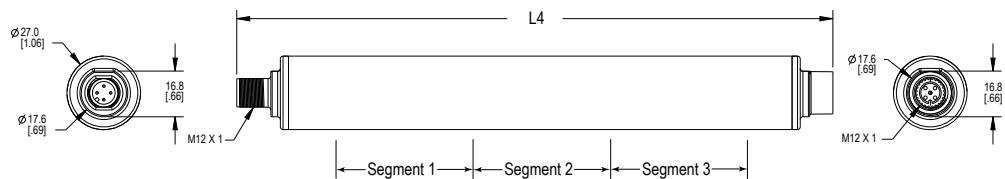

Figure 4. Cascade models, three segment example model shown

[†] Values are shown at 25 °C. Current and lumen values decrease 0.4% per 1 °C from the ambient temperature. For example, an 850 mm unit will have a maximum current of 0.851 A at -40 °C and 1.2 A at +50 °C.

Models	L1	L2	L3	L4	Segment 1	Segment 2	Segment 3
WLS27..0285..	286 mm (11.3 in)	330 (13 in)	349.5 mm (13.8 in)	358 mm (14.1 in)	143 mm (5.7 in)	143 mm (5.7 in)	-
WLS27..0430..	427 mm (16.8 in)	471 mm (18.5 in)	490.5 mm (13.3 in)	499 mm (19.6 in)	143 mm (5.7 in)	143 mm (5.7 in)	143 mm (5.7 in)
WLS27..0570..	569 mm (22.4 in)	612 mm (24.1 in)	631.5 mm (24.9 in)	640 mm (25.2 in)	286 mm (11.3 in)	286 mm (11.3 in)	-
WLS27..0850..	849 mm (33.4 in)	893 mm (35.2 in)	912.5 mm (35.9 in)	921 mm (36.2 in)	286 mm (11.3 in)	286 mm (11.3 in)	286 mm (11.3 in)



Accessories

Cordsets

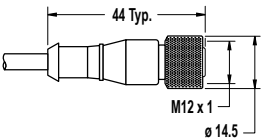
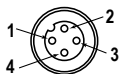
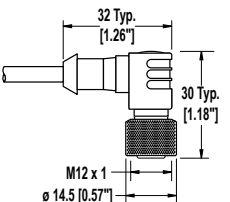
Use single-ended cordsets between the power source and the quick disconnect connection of a stand-alone light or the first light in a cascade. Use double-ended cordsets between lights in a cascade.

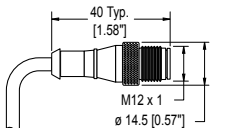
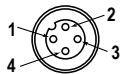
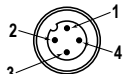
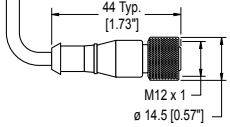
4-Pin Threaded M12/Euro-Style Cordsets—Single Ended				
Model	Length	Style	Dimensions	Pinout (Female)
MQDC-406	1.83 m (6 ft)	Straight		 <p>1 = Brown 2 = White 3 = Blue 4 = Black</p>
MQDC-415	4.57 m (15 ft)			
MQDC-430	9.14 m (30 ft)			
MQDC-450	15.2 m (50 ft)	Right-Angle		
MQDC-406RA	1.83 m (6 ft)			
MQDC-415RA	4.57 m (15 ft)			
MQDC-430RA	9.14 m (30 ft)			
MQDC-450RA	15.2 m (50 ft)			

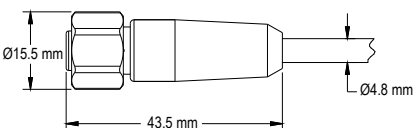
4-Pin Threaded M12/Euro-Style Cordsets—Double Ended				
Model	Length	Style	Dimensions	Pinout
MQDEC-401SS	0.31 m (1 ft)	Male Straight/Female Straight		Female
MQDEC-403SS	0.91 m (3 ft)			
MQDEC-406SS	1.83 m (6 ft)			Male
MQDEC-412SS	3.66 m (12 ft)			
MQDEC-420SS	6.10 m (20 ft)			<p>1 = Brown 2 = White 3 = Blue 4 = Black</p>
MQDEC-430SS	9.14 m (30 ft)			
MQDEC-450SS	15.2 m (50 ft)			

4-Pin Threaded M12/Euro-Style Cordsets—Washdown, Stainless Steel, Single Ended				
Model	Length	Style	Dimensions	Pinout (Female)
MQDC-WDSS-0406	1.83 m (6 ft)	Straight		 <p>1 = Brown 2 = White 3 = Blue 4 = Black</p>
MQDC-WDSS-0415	4.57 m (15 ft)			
MQDC-WDSS-0430	9.14 m (30 ft)			

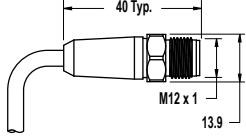
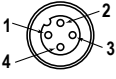
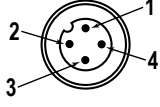
4-Pin Threaded M12/Euro-Style Cordsets—Double Ended, Washdown, Stainless Steel				
Model	Length	Style	Dimensions	Pinout
MQDEC-WDSS-401SS	0.3 m (1 ft)	Male Straight/Female Straight		Female
MQDEC-WDSS-403SS	0.91 m (3 ft)			
MQDEC-WDSS-406SS	1.83 m (6 ft)			Male
MQDEC-WDSS-412SS	3.66 m (12 ft)			 <p>1 = Brown 2 = White 3 = Blue 4 = Black</p>

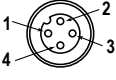
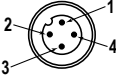
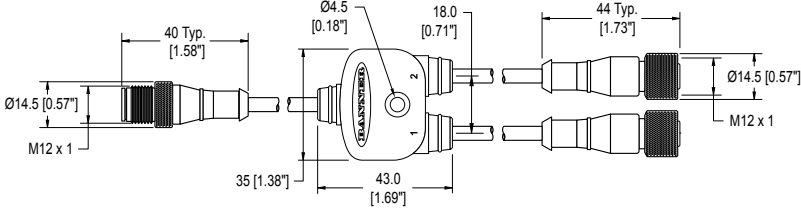
4-Pin Threaded M12/Euro-Style Splitter Cordsets—Flat Junction			
Model	Branches (Female)	Trunk (Male)	Pinout
CSB-M1240M1240	No branch	No trunk	 <p>Female</p>  <p>Male</p> <p>1 = Brown 2 = White 3 = Blue 4 = Black</p>
CSB-M1240M1241	2 x 0.30 m (1 ft)	No trunk	
CSB-M1241M1241		0.30 m (1 ft)	
CSB-M1248M1241		2.50 m (8 ft)	
CSB-M12415M1241		4.57 m (15 ft)	
CSB-M12425M1241		7.60 m (25 ft)	
CSB-UNT425M1241		7.60 m (25 ft) Unterminated	
			

Brackets

LMBWLS27EC

- Clear copolyester
- Clearance for M5 or #10 hardware

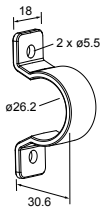

LMBWLS27H

- 300 series stainless steel mounting brackets
- M4 stainless steel hardware included

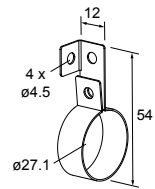

LMBWLS27SP

- Clear copolyester
- Clearance for M5 or #10 hardware
- Snap bracket for light duty applications

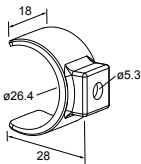

LMBWLS27T

- Stainless steel mounting brackets with rubber grips
- M5 stainless steel hardware included
- Clearance for M5 or #10 hardware

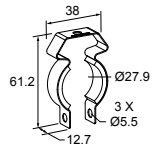

LMBWLS27U

- Clear copolyester
- Clearance for M5 or #10 hardware
- Clamps securely around the light body

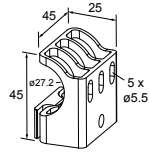

Banner Engineering Corp. Limited Warranty

Banner Engineering Corp. warrants its products to be free from defects in material and workmanship for one year following the date of shipment. Banner Engineering Corp. will repair or replace, free of charge, any product of its manufacture which, at the time it is returned to the factory, is found to have been defective during the warranty period. This warranty does not cover damage or liability for misuse, abuse, or the improper application or installation of the Banner product.

THIS LIMITED WARRANTY IS EXCLUSIVE AND IN LIEU OF ALL OTHER WARRANTIES WHETHER EXPRESS OR IMPLIED (INCLUDING, WITHOUT LIMITATION, ANY WARRANTY OF MERCHANTABILITY OR FITNESS FOR A PARTICULAR PURPOSE), AND WHETHER ARISING UNDER COURSE OF PERFORMANCE, COURSE OF DEALING OR TRADE USAGE.

This Warranty is exclusive and limited to repair or, at the discretion of Banner Engineering Corp., replacement. **IN NO EVENT SHALL BANNER ENGINEERING CORP. BE LIABLE TO BUYER OR ANY OTHER PERSON OR ENTITY FOR ANY EXTRA COSTS, EXPENSES, LOSSES, LOSS OF PROFITS, OR ANY INCIDENTAL, CONSEQUENTIAL OR SPECIAL DAMAGES RESULTING FROM ANY PRODUCT DEFECT OR FROM THE USE OR INABILITY TO USE THE PRODUCT, WHETHER ARISING IN CONTRACT OR WARRANTY, STATUTE, TORT, STRICT LIABILITY, NEGLIGENCE, OR OTHERWISE.**

Banner Engineering Corp. reserves the right to change, modify or improve the design of the product without assuming any obligations or liabilities relating to any product previously manufactured by Banner Engineering Corp. Any misuse, abuse, or improper application or installation of this product or use of the product for personal protection applications when the product is identified as not intended for such purposes will void the product warranty. Any modifications to this product without prior express approval by Banner Engineering Corp will void the product warranties. All specifications published in this document are subject to change; Banner reserves the right to modify product specifications or update documentation at any time. Specifications and product information in English supersede that which is provided in any other language. For the most recent version of any documentation, refer to: www.bannerengineering.com.

For patent information, see www.bannerengineering.com/patents.

Mexican Importer

Banner Engineering de México, S. de R.L. de C.V.
 David Alfaro Siqueiros 103 Piso 2 Valle oriente
 San Pedro Garza García Nuevo León, C. P. 66269
 81 8363.2714