

Instruction Manual Quick Start Guide

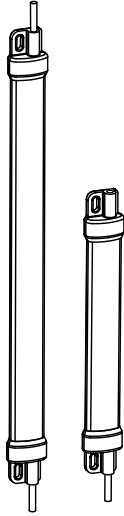

Banner's WLS15 LED Strip Lights have sturdy aluminum inner frames, encased in shatter resistant, UV-stabilized, polycarbonate shells, making them ideal for indoor and outdoor applications.

- Low-profile, space-saving design
- Rugged, water-resistant design
- Available in six lengths from 220 mm to 1200 mm
- Daisy chain power to multiple lights
- Optional snap clips for easy installation and repositioning
- Capability to dim lights using PWM input
- Operates on 12 V DC or 24 V DC in one model
- Models are available with two colors in one device

These Work Light Strips are available as either stand-alone models, or as cascade models that can be "daisy-chained" together for longer lighting runs, with a minimum of wiring.

Stand-alone models have one end for power connection and no connections at opposite end. A stand-alone model may be used as the last in the cascade series.

Cascade models have one end for power connection, and a connection at the opposite end for connecting to other lights in the cascade. A double-ended accessory cordset may be used between each pair of lights in a cascade to extend the distance between lights.



For PWM dimming, use with the LC65P2T 2-wire dimmer module. For more information, refer to the LC65 LED Dimmer Module datasheet, p/n [177086](#). This module can only be used with the single color models.

IMPORTANT: Read the following instructions before operating the light. Please download the complete WLS15 LED Strip Light technical documentation, available in multiple languages, from www.bannerengineering.com for details on the proper use, applications, Warnings, and installation instructions of this device.

IMPORTANT: Lea el siguiente instructivo antes de operar el luminario. Por favor descargue desde www.bannerengineering.com toda la documentación técnica de los WLS15 LED Strip Light, disponibles en múltiples idiomas, para detalles del uso adecuado, aplicaciones, advertencias, y las instrucciones de instalación de estos dispositivos.

IMPORTANT: Lisez les instructions suivantes avant d'utiliser le luminaire. Veuillez télécharger la documentation technique complète des WLS15 LED Strip Light sur notre site www.bannerengineering.com pour les détails sur leur utilisation correcte, les applications, les notes de sécurité et les instructions de montage.

Single Color Models

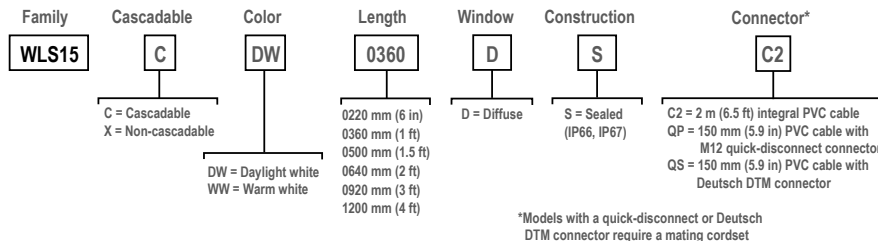

Dual Color Models

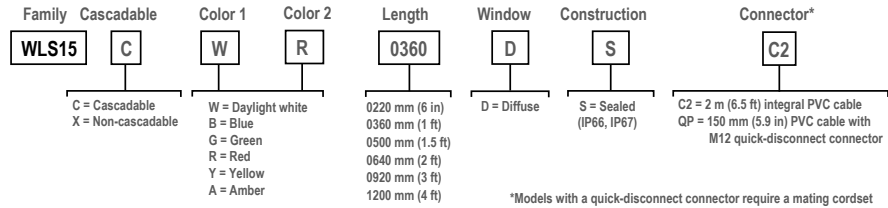

Wiring Diagrams

QP Models					
Male	Female	Pin	Wire Color	Single Color Models	Dual Color Models
		1	brown	12 V DC or 24 V DC	Color 1: 12 V DC or 24 V DC
		3	blue	DC common	DC common
		4	black	Not used	Color 2: 12 V DC or 24 V DC (color 2 overrides color 1)
		2	white	Not used	Not used

QS Models: Single Color Models Only					
Male	Female	Pin	Wire Color	Connection	
		1	brown	12 V DC or 24 V DC	
		2	blue	DC common	

Specifications

Supply Protection Circuitry

Protected against reverse polarity and transient voltages

Supply Voltage

12 V DC or 24 V DC nominal

Absolute operational limits of 10 V DC to 15 V DC and 20 V DC to 27 V DC

Use only with a suitable Class 2 power supply (UL) or a SELV power supply (CE)

Single Color Light Models can be PWM dimmed between 25% to 100% with a frequency up to 1000 Hz

See electrical characteristics on the product's label

Supply Current

Light Length	Typical Current (A) at 25°C ⁽¹⁾		Max. Current (A) at -40°C	
	12 V DC	24 V DC	12 V DC	24 V DC
0220 mm	0.19	0.10	0.24	0.12
0360 mm	0.38	0.20	0.48	0.24
0500 mm	0.57	0.30	0.72	0.36
0640 mm	0.76	0.40	0.96	0.48
0920 mm	1.14	0.60	1.44	0.72
1200 mm	1.52	0.80	1.92	0.96

⁽¹⁾ Typical current values are shown at 25 °C – current and lumen values decrease 0.4% per 1 °C from ambient. For example, a 1200 mm unit will have a maximum current of 1.92 A at -40 °C and 1.33 A at +60 °C.

Connections

2 m (6.5 ft) integral PVC-jacketed cable, 150 mm (6 in) PVC-jacketed cable with a 4-pin M12 male quick-disconnect connector, or 150 mm (5.9 in) 2-pin Deutsch DTM series sealed cable; models with a quick disconnect or Deutsch DTM connector require a mating cordset

Do not spray the cable with a high-pressure sprayer or cable damage will result.

Mounting

Integral mounting slots for M4 (#8) screws, tighten to 5 in-lbf max torque

Multiple bracket options available

Secure cables within 150 mm (5.9 inches) of the light

Construction

Clear anodized aluminum housing; Polycarbonate outer housing, Polyamide end caps

Environmental Rating

Rated IP66 and IP67

Suitable for wet locations per UL 2108

Vibration and Mechanical Shock

Vibration: 10 Hz to 55 Hz, 1.0 mm peak-to-peak amplitude per IEC 60068-2-6

Shock: 15G 11 ms duration, half sine wave per IEC 60068-2-27

Operating Temperature

-40 °C to +60 °C (-40 °F to +140 °F)

95% at +60 °C maximum relative humidity (non-condensing)

Storage Temperature

-40 °C to +70 °C (-40 °F to +158 °F)

Application Note

When connecting cascadable lights in series, it is important not to exceed maximum current limitations:

- Maximum length of light at 12 V DC: 2.4 m (7.9 ft)
- Maximum length of light at 24 V DC: 6 m (19.7 ft)

Light Characteristics

Color	Dominant Wavelength (nm) or Color Temperature	Lighted Length Lumens (Typical at 25°C) ⁽¹⁾					
		220 mm	360 mm	500 mm	640 mm	920 mm	1200 mm
Daylight White	5000K (±300K)	175	350	525	700	1050	1400
Warm White	3000K (±200K, -100K)	170	340	510	680	1020	1360
Green	525 nm	105	210	315	420	630	840
Red	625 nm	55	110	165	220	330	440
Yellow	580 nm	165	330	495	660	990	1320
Blue	470 nm	25	50	75	100	150	200
Amber	590 nm	55	110	165	220	330	440

⁽¹⁾ Values shown at 25°C - current and lumen values decrease 0.4% per 1°C from ambient. For example, a 1200 mm unit will have a maximum current of 1.92 A at -40°C and 1.33 A at +60°C.

Certifications



Banner Engineering BV
Park Lane, Culliganlaan 2F bus 3
1831 Diegem, BELGIUM

Dimensions

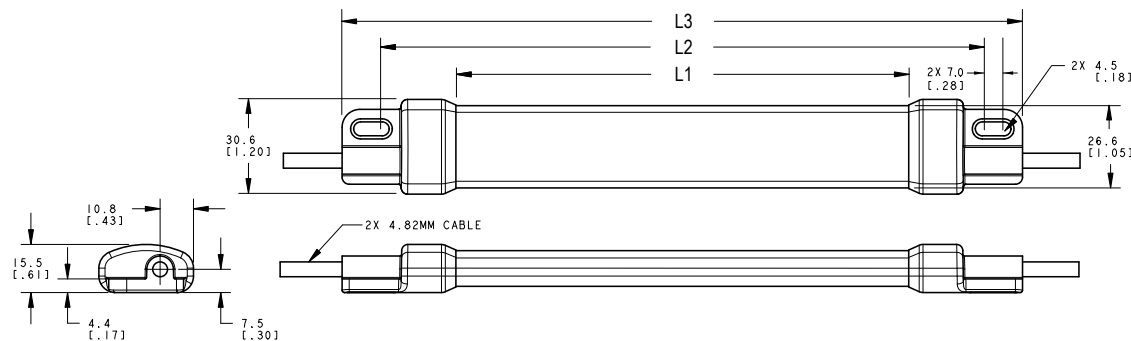

Models	L1	L2	L3
WLS15..0220..	146.4 mm (5.76 inches)	194 mm (7.64 inches)	220 mm (8.66 inches)
WLS15..0360..	286.4 mm (11.28 inches)	334 mm (13.15 inches)	360 mm (14.17 inches)
WLS15..0500..	426.4 mm (16.79 inches)	474 mm (18.66 inches)	500 mm (19.69 inches)
WLS15..0640..	566.4 mm (22.3 inches)	614 mm (24.17 inches)	640 mm (25.2 inches)
WLS15..0920..	846.4 mm (33.32 inches)	894 mm (35.2 inches)	920 mm (36.22 inches)
WLS15..1200..	1126.4 mm (44.35 inches)	1174 mm (46.22 inches)	1200 mm (47.24 inches)

Performance Curves

Optical data shown below is for daylight white only. To get lux and candela values for warm white, green, red, yellow, blue, and amber, multiply the values shown on the charts by the following factors:

<ul style="list-style-type: none"> • Warm white: 0.971 • Green: 0.600 • Red: 0.314 	<ul style="list-style-type: none"> • Yellow: 0.943 • Blue: 0.143 • Amber: 0.314
---	--

220 mm Models

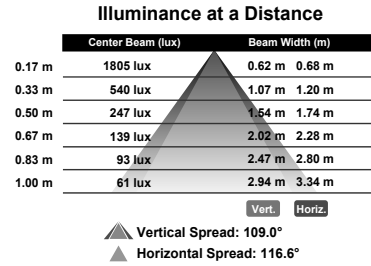
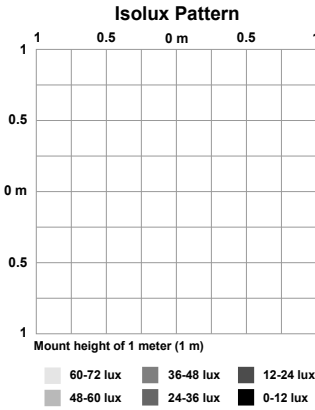
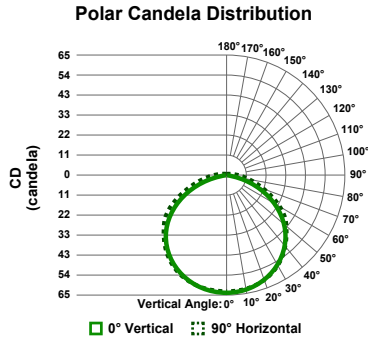

360 mm Models

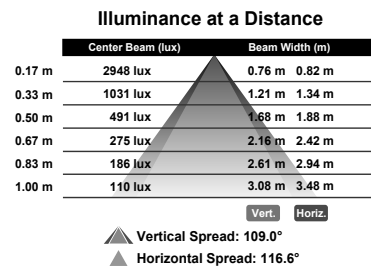
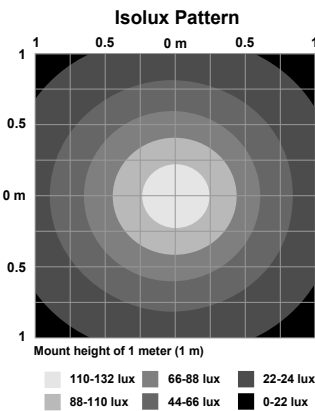
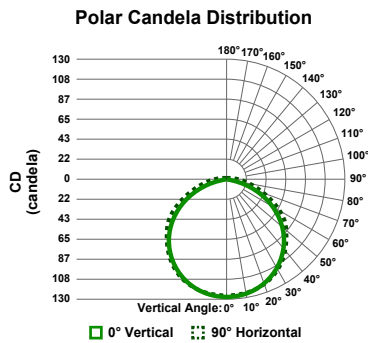

500 mm Models

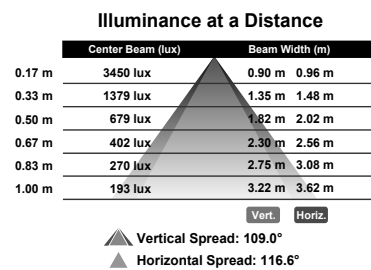
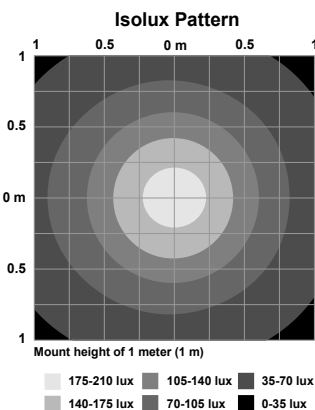
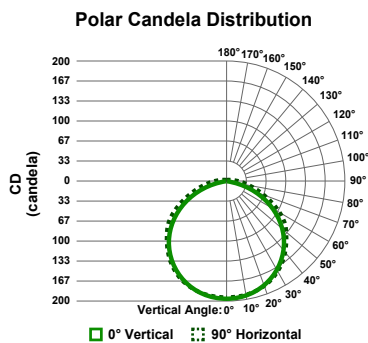

640 mm Models

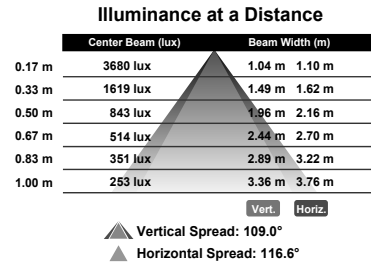
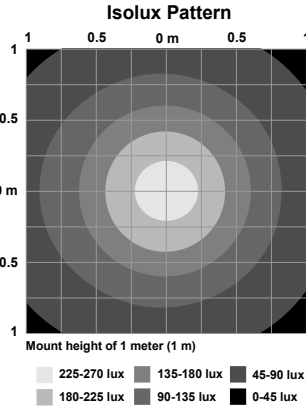
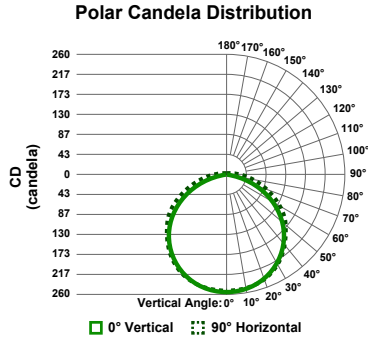

920 mm Models

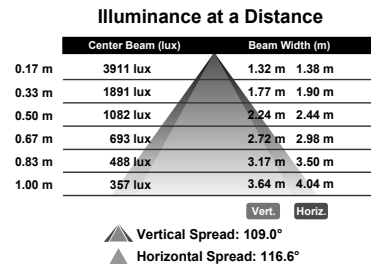
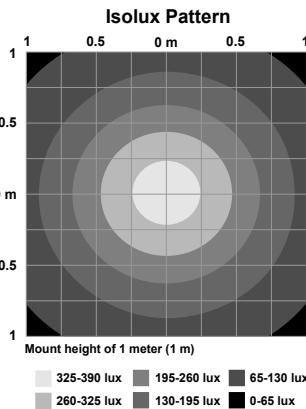
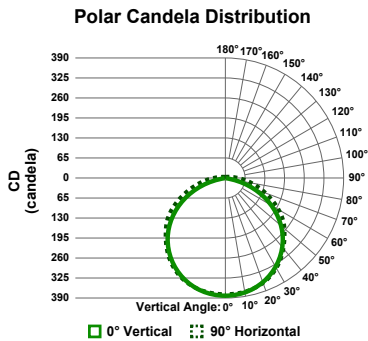

1200 mm Models

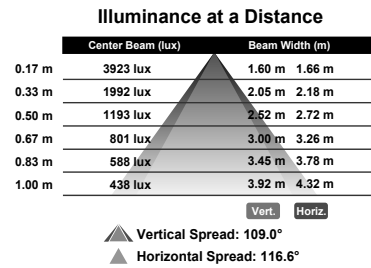
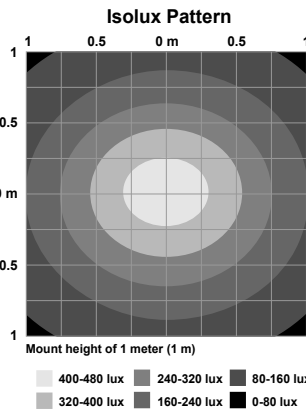
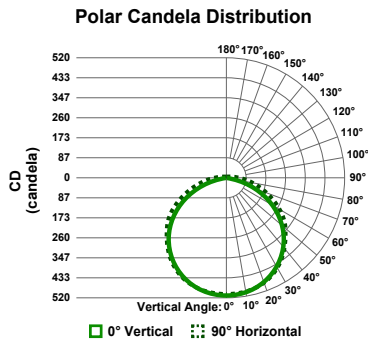

Accessories

Cordsets

Use single-ended cordsets between the power source and the QD connection of a stand-alone light or the first light in a cascade. Use double-ended cordsets between lights in a cascade.

4-Pin Threaded M12 Cordsets—Single Ended				
Model	Length	Style	Dimensions	Pinout (Female)
MQDC-406	2 m (6.56 ft)	Straight		
MQDC-415	5 m (16.4 ft)			
MQDC-430	9 m (29.5 ft)			
MQDC-450	15 m (49.2 ft)	Right-Angle		
MQDC-406RA	2 m (6.56 ft)			
MQDC-415RA	5 m (16.4 ft)			
MQDC-430RA	9 m (29.5 ft)			
MQDC-450RA	15 m (49.2 ft)			<p>1 = Brown 2 = White 3 = Blue 4 = Black 5 = Unused</p>

4-Pin Threaded M12 Cordsets—Double Ended				
Model	Length	Style	Dimensions	Pinout
MQDEC-401SS	0.31 m (1 ft)	Male Straight/Female Straight		<p>Female</p>
MQDEC-403SS	0.91 m (2.99 ft)			
MQDEC-406SS	1.83 m (6 ft)			
MQDEC-412SS	3.66 m (12 ft)			
MQDEC-420SS	6.10 m (20 ft)			
MQDEC-430SS	9.14 m (30.2 ft)			
MQDEC-450SS	15.2 m (49.9 ft)			<p>Male</p> <p>1 = Brown 2 = White 3 = Blue 4 = Black</p>

4-Pin Threaded M12 Splitter Cordsets—Flat Junction			
Model	Branches (Female)	Trunk (Male)	Pinout
CSB-M1240M1240	No branch	No trunk	<p>Female</p> <p>Male</p> <p>1 = Brown 2 = White 3 = Blue 4 = Black</p>
CSB-M1240M1241	2 × 0.3 m (1 ft)	No trunk	
CSB-M1241M1241		0.30 m (1 ft)	
CSB-M1248M1241		2.44 m (8 ft)	
CSB-M12415M1241		4.57 m (15 ft)	
CSB-M12425M1241		7.60 m (25 ft)	
CSB-UNT425M1241		7.60 m (25.0 ft) Unterminated	

Single Color Only Cordsets





2-Pin Deutsch Cordset—Single Ended				
Model	Length	Style	Dimensions	Pinout
DTMC-206	1.83 m (6 ft)	Straight		Male
DTMC-215	4.57 m (15 ft)			Female
DTMC-230	9.15 m (30 ft)			<p>1 = Brown 2 = Blue</p>

2-Pin Deutsch Cordset—Double Ended				
Model	Length	Style	Dimensions	Pinout
DTMEC-2005	0.16 m (0.5 ft)	Straight		Male
DTMEC-201	0.31 m (1 ft)			Female
DTMEC-203	0.91 m (3 ft)			<p>1 = Brown 2 = Blue</p>
DTMEC-206	1.83 m (6 ft)			
DTMEC-212	3.66 m (12 ft)			
DTMEC-220	6.10 m (20 ft)			
DTMEC-230	9.15 m (30 ft)			

Mounting Accessories

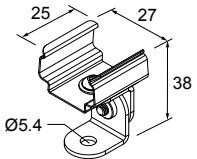
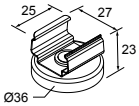
All measurements are listed in millimeters [inches], unless noted otherwise.

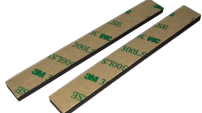
<p>LMBWLS15</p> <ul style="list-style-type: none"> • Stainless steel clip bracket • Includes 3 clip brackets and 2 plastic spacers • Clearance hole for M5 hardware 	
---	--

<p>LMBWLS15-150S</p> <ul style="list-style-type: none"> • Set of 2 stainless steel swivel bracket, allows for 150° of movement • Clearance hole for M5 button head screw 	
<p>LMBWLS15MAG</p> <ul style="list-style-type: none"> • Set of 2 brackets • Magnetic mounting bracket for attachment to steel and iron surfaces 	
<p>LMBWLS15TD</p> <ul style="list-style-type: none"> • Includes 4 100 mm (4 in) strips of 3M™ Dual Lock™ reclosable fasteners • Recommended for mounting to metal and plastic surfaces • Strong, pressure-sensitive adhesive bonds on contact 	
<p>LMBWLS15TF</p> <ul style="list-style-type: none"> • Includes 2 100 mm (4 in) strips of double-sided foam urethane strips • Acrylic adhesive provides high bond strength to most surfaces • Bonds to low surface energy plastics such as polypropylene and powder-coated paints 	
<p>ACC-CAP M12-10</p> <ul style="list-style-type: none"> • 10 Caps • Seal and protect exposed, unterminated cascade quick disconnect connectors 	

Power Supplies

For use with cascades of lights that do not exceed a total maximum operating current of 4A (refer to maximum current specifications):

<p>PSD-24-4</p> <ul style="list-style-type: none"> • 90 to 264 V AC 50/60 Hz input • Includes a 1.8 m (6 ft) US style 5-15P input plug • 24 V DC UL Listed Class 2 M12 connector output • 4 A total current 	
--	---

For use with all non-cascaded lights or cascades of lights that do not exceed a total maximum operating current of 1A (refer to maximum current specifications):

<p>PSW-24-1</p> <ul style="list-style-type: none"> • 24 V DC, 1 A Class 2 UL Listed power supply • 100 V AC to 240 V AC 50/60 Hz input • 2 m (6.5 ft) PVC cable with M12 quick disconnect • Includes Type A (US, Canada, Japan, Puerto Rico, Taiwan), Type C (Germany, France, South Korea, Netherlands, Poland, Spain, Turkey), Type G (United Kingdom, Ireland, Singapore, Vietnam), and Type I (China, Australia, New Zealand) AC detachable input plugs 	
--	---

Banner Engineering Corp Limited Warranty

Banner Engineering Corp. warrants its products to be free from defects in material and workmanship for one year following the date of shipment. Banner Engineering Corp. will repair or replace, free of charge, any product of its manufacture which, at the time it is returned to the factory, is found to have been defective during the warranty period. This warranty does not cover damage or liability for misuse, abuse, or the improper application or installation of the Banner product.

THIS LIMITED WARRANTY IS EXCLUSIVE AND IN LIEU OF ALL OTHER WARRANTIES WHETHER EXPRESS OR IMPLIED (INCLUDING, WITHOUT LIMITATION, ANY WARRANTY OF MERCHANTABILITY OR FITNESS FOR A PARTICULAR PURPOSE), AND WHETHER ARISING UNDER COURSE OF PERFORMANCE, COURSE OF DEALING OR TRADE USAGE.

This Warranty is exclusive and limited to repair or, at the discretion of Banner Engineering Corp., replacement. **IN NO EVENT SHALL BANNER ENGINEERING CORP. BE LIABLE TO BUYER OR ANY OTHER PERSON OR ENTITY FOR ANY EXTRA COSTS, EXPENSES, LOSSES, LOSS OF PROFITS, OR ANY INCIDENTAL, CONSEQUENTIAL OR SPECIAL DAMAGES RESULTING FROM ANY PRODUCT DEFECT OR FROM THE USE OR INABILITY TO USE THE PRODUCT, WHETHER ARISING IN CONTRACT OR WARRANTY, STATUTE, TORT, STRICT LIABILITY, NEGLIGENCE, OR OTHERWISE.**

Banner Engineering Corp. reserves the right to change, modify or improve the design of the product without assuming any obligations or liabilities relating to any product previously manufactured by Banner Engineering Corp. Any misuse, abuse, or improper application or installation of this product or use of the product for personal protection applications when the product is identified as not intended for such purposes will void the product warranty. Any modifications to this product without prior express approval by Banner Engineering Corp will void the product warranties. All specifications published in this document are subject to change; Banner reserves the right to modify product specifications or update documentation at any time. Specifications and product information in English supersede that which is provided in any other language. For the most recent version of any documentation, refer to: www.bannerengineering.com.

For patent information, see www.bannerengineering.com/patents.

Mexican Importer

Banner Engineering de México, S. de R.L. de C.V. | David Alfaro Siqueiros 103 Piso 2 Valle oriente | San Pedro Garza Garcia Nuevo León, C. P. 66269

81 8363.2714

Document title: WLS15 LED Strip Light Instruction Manual

Part number: 197493

Revision: H

Original Instructions

© Banner Engineering Corp. All rights reserved.



197493