

Datasheet

3-wire AC Self-Contained Sensors with Solid-State Outputs

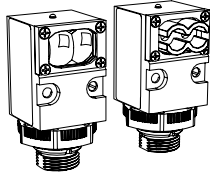

- Sensors with 3-wire hookup for 24 V ac to 130 V ac
- All sensing modes available: opposed, retroreflective, diffuse (proximity), convergent, and fiberoptic
- Switch-selectable light- or dark-operate
- Totally encapsulated circuitry in a rugged, molded plastic housing; NEMA 1, 2, 3, 3S, 4, 4X, 12, and 13
- Integral conduit fitting and 1.8 m (6 ft) PVC-covered cable supplied on standard models; NEMA-4 Turck *Minifast*™ Quick Disconnect cable/connector combination optional
- Adjustable sensitivity
- Versatile mounting options



WARNING:

- Do not use this device for personnel protection
- Using this device for personnel protection could result in serious injury or death.
- This device does not include the self-checking redundant circuitry necessary to allow its use in personnel safety applications. A device failure or malfunction can cause either an energized (on) or de-energized (off) output condition.

Models

To order the 9 m (30 ft) PVC cable model, add the suffix "W/30" to the cabled model number. For example, SMA91E W/30.

To order the quick-disconnect (QD) model, add the suffix "QD" to the model number. For example, SMA91EQD. A model with a QD connector requires a mating cable; see [Quick-Disconnect Cordsets](#) (p. 6).

Opposed Mode Emitter (E) and Receiver (R) Models

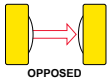

OPPOSED

Infrared, 880 nm

Opposed mode sensors have higher excess gain than other models, and therefore should be used whenever possible. The small size of these sensors makes them ideal for many conveyor applications. Their small effective beam size (particularly of the ESR/RSR models) enables them to reliably detect relatively small objects. VALU-BEAM opposed mode sensors have a visible red tracer beam which simplifies sensor alignment. ESR/RSR models have a wide beam angle for very forgiving alignment within the 3 m (10 ft) range. E/R models have a narrow beam spread and should be used when it is important to minimize optical crosstalk between adjacent emitter-receiver pairs at close range in multiple sensor arrays.

Models	Range	Supply Voltage	Response	Repeatability	Effective Beam
SMA91E	61 m (200 ft)	10 V ac/dc to 250 V ac/dc	8 ms on/4 ms off	1 ms	0.5 in diameter
SMA91R		24 V ac to 130 V ac			
SMA91ESR	3 m (10 ft)	24 to 130 V ac	8 ms on/4 ms off		0.14 in diameter
SMA91RSR					

Retroreflective Models

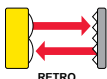

RETRO

Non-Polarized

Visible red, 650 nm



POLAR RETRO

Polarized

A visible-red light beam reduces the potential for false signals from highly reflective objects (proxing) and simplifies alignment. Anti-glare (AG) models polarize the emitted light and filter out unwanted reflections, making their use possible in applications otherwise unsuited to retroreflective sensing (when reduced excess gain is acceptable). Maximum range with "LV" units is attained when using the model BRT-3 76 mm (3 in) corner cube reflector. For details on retroreflective target materials, see www.bannerengineering.com.

Models	Range	Supply Voltage	Response	Repeatability	Beam
SMA912LV	152.4 mm to 9.1 m (6 in to 30 ft)	24 V ac to 130 V ac	4 ms on/4 ms off	1.3 ms	Visible red, 650 nm
SMA912LVAG	0.3 m to 4.6 m (1 ft to 15 ft)				Visible red, 650 nm with polarizing filter

Diffuse Mode Models

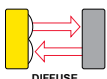

DIFFUSE

Infrared, 880 nm

These sensors operate by detecting the reflection of their own light from the object being sensed, and require no special reflectors. "DSR" models have better response than "D" models to objects within 76 mm (3 inches) of the sensor. Use "DSR" models when it is necessary to minimize sensor response to background objects.



Models	Range	Supply Voltage	Response	Repeatability
SMA912D	762 mm (30 in)	24 V ac to 130 V ac	4 ms on/4 ms off	1.3 ms
SMA912DSR	381 mm (15 in)			

Convergent Mode Models



VALU-BEAM convergent sensors produce a precise 1.5 mm (0.06 in) diameter sensing spot at a focus point 38 mm (1.5 inches) in front of the sensor lens. Due to their very narrow depth of field, they excel at detecting small objects only a fraction of an inch away from backgrounds. They are also ideal for some high-contrast color-registration applications. Their visible red sensing beam simplifies alignment.

Visible red, 650 nm

Models	Focus	Supply Voltage	Response	Repeatability
SMA912CV	38 mm (1.5 in)	24 V ac to 130 V ac	4 ms on/4 ms off	1.3 ms

Opposed Fiber Optic Mode (Glass Fibers)



The opposed mode fiber optic emitter-receiver pairs are used where the separation between emitting and receiving fibers is greater than a few feet, or where it is inconvenient to run both fibers from a single VALUBEAM sensor. These models have a watertight o-ring sealed sensor/fiber interface, and are compatible with all Banner glass fiber optic assemblies (see www.bannerengineering.com).

Infrared, 880 nm

Models	Range	Supply Voltage	Response	Repeatability
SMA91EF	See the Excess Gain curves	10 V ac/dc to 250 V ac/dc	8 ms on/4 ms off	1 ms
SMA91RF		24 V ac to 130 V ac		

Glass Fiber Optic Models

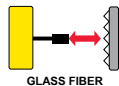
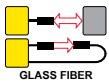

Fiber optic sensing is often the answer when, due to space or environmental limitations, the sensor itself cannot be placed at the actual sensing position. These sensors' powerful modulated infrared beam is compatible with all Banner glass fiber optics in the opposed, retroreflective, and diffuse sensing modes. See www.bannerengineering.com for glass fiber optic selection information. Sensor/fiber interface is waterproof to maintain complete sensing system moisture rejection.

Infrared, 880 nm

Models	Range	Supply Voltage	Response	Repeatability
SMA912F	See the Excess Gain curves	24 V ac to 130 V ac	4 ms on/4 ms off	1.3 ms

Overview

Banner SMA912 Series VALU-BEAMs are rugged, self-contained photoelectric sensors designed for especially demanding industrial applications where economy, performance, and durability are important.

SMA912 Series sensors may be mounted from either the front or the rear using their two through-mounting holes, or by the outside threads of their base (mounting nut supplied), making them ideal for conveyor and other production line applications.

Power modulated LED light sources give the SMA912 a high degree of immunity to ambient light.

SMA912 Series VALU-BEAM sensors have an easily visible top-mounted red LED indicator to assist in alignment and system monitoring. SMA912 series sensors have Banner's Alignment Indicating Device (AID™) system¹, which lights the indicator LED whenever the sensor sees its modulated light source, and also pulses the LED at a rate proportional to the received light signal strength.

¹ US patent #4356393

Wiring Diagrams

Key

- 1 = Brown
- 3 = Blue
- 4 = Black

Emitters²

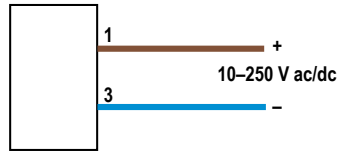

All Other Models

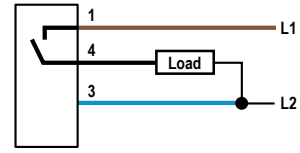

Specifications

Supply Voltage

24 V ac to 130 V ac (50/60Hz), except for SMA91E, ESR, and EF emitters, which operate from 10 V ac/dc to 250 V ac/dc

Output Configuration

Solid-state switching element

Output Rating

500 mA continuous (60 VA); 5 A inrush

Response Time

4 milliseconds ON, 8 milliseconds OFF (except receiver-only units, which are 4 ms ON and 4 ms OFF)
Response time specification of the load should be considered when important

Repeatability

1.3 milliseconds, except for receiver-only units, which are 1.0 millisecond

Environmental Rating

Meets NEMA standards 1, 2, 3, 3S, 4, 4X, 12, and 13

Construction

Reinforced PBT polyester housing
Totally encapsulated, molded acrylic lenses
Stainless steel hardware

Cable

2 m (6.5 ft) PVC-jacketed 3-conductor cable standard
3-pin quick-disconnect (QD) models are available (one connector pin is unused for emitters). A model with a QD connector requires a mating cable.

Adjustments

LIGHT/DARK OPERATE select switch and SENSITIVITY control potentiometer, both located on the rear of the sensor

Indicator LED

Top-mounted red AID™ system³ LED indicator turns on when the sensor sees its own (or its emitter's) modulated light, and pulses at a rate proportional to the received signal strength
Model SMA91E emitter has a visible-red tracer beam which indicates power on and enables easy line-of-sight alignment

Operating Temperature

-20 °C to +70 °C (-4 °F to +158 °F)

Dimensions

Cabled Models

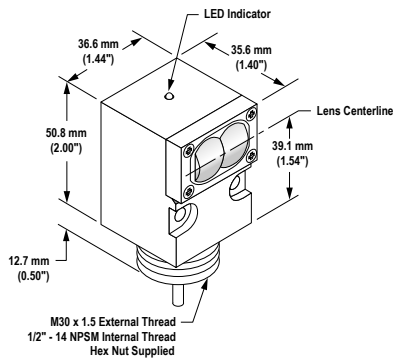

QD Models

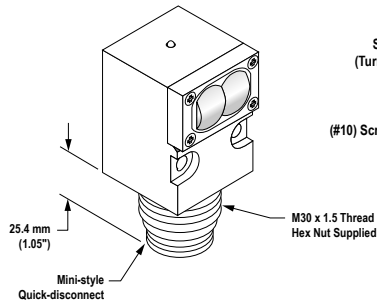

Rear View

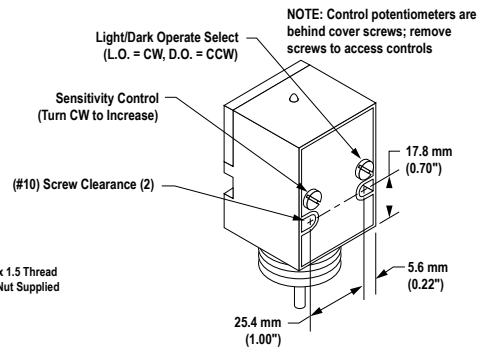

Note: Emitters have no light/dark operate switch, sensitivity control, or indicator LED.

Excess Gain Curves

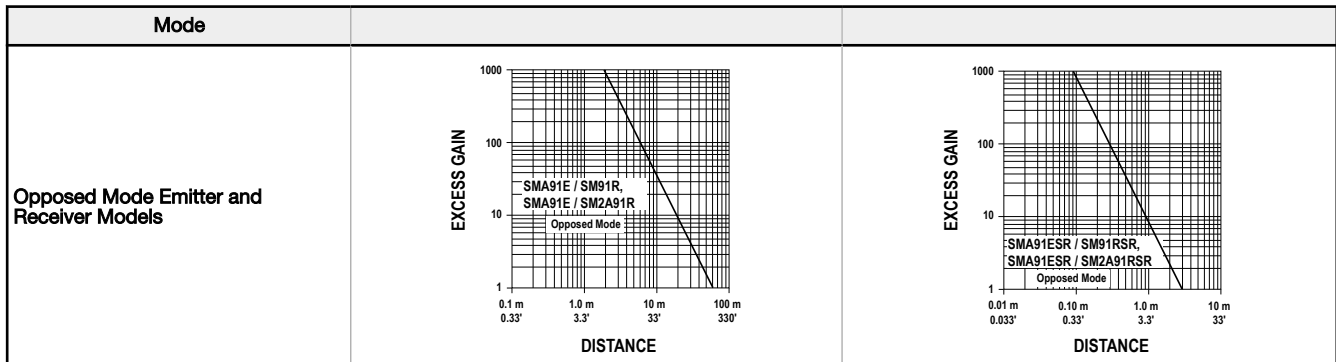

² There is no polarity for emitter hookup to ac voltage.
³ US Patent #4356393

Mode		
Retroreflective Mode Models		
Diffuse Mode Models		
Convergent Mode Models		
Opposed Glass Fiber Optic Models		
Glass Fiber Optic Models		

Beam Patterns

Mode		
<p>Opposed Mode Emitter and Receiver Models</p>		
<p>Retroreflective Mode Models</p>		
<p>Diffuse Mode Models</p>		
<p>Convergent Mode Models</p>		
<p>Opposed Glass Fiber Optic Models</p>		

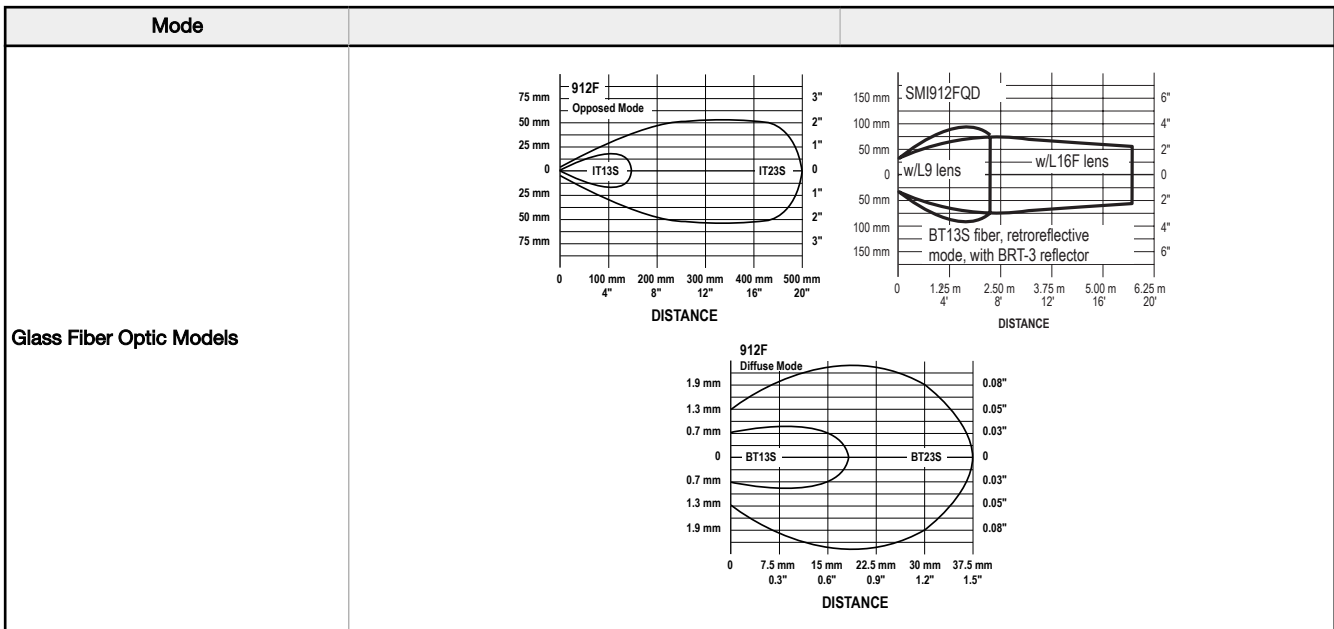

Accessories

Quick-Disconnect Cordsets

3-Pin Mini-Style Cordsets				
Model	Length	Style	Dimensions	Pinout (Female)
MBCC-306	1.83 m (6 ft)	Straight		<p>1 = Brown 3 = Blue 4 = Black</p>
MBCC-312	3.66 m (12 ft)			
MBCC-330	9.14 m (30 ft)			

Cabling Accessories

Model	Description	
AC-6	2 m (6.5 ft) armored cable jacket	I.D. 5/16-in; O.D. 7/16-in
PVC-6	2 m (6.5 ft) flexible PVC tubing (not for QD models)	I.D. 1/4-in; O.D. 3/8-in
RF1-2NPS	Compression fitting for attaching armored cable or PVC tubing	-
HF1-2NPS	<ul style="list-style-type: none"> Flexible black nylon cable protector Includes a neoprene gland that compresses around the VALU-BEAM cable to provide an additional seal against moisture Resistant to gasoline, alcohol, oil, grease, solvents and weak acids Working temperature range of -30 °C to +100 °C (-22 °F to +212 °F) 	

Mounting Brackets

SMB900

- Right Angle Mounting
- 11 Gauge Stainless Steel
- Curved mounting slot for versatility/orientation

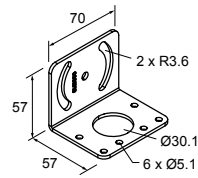

SMB30C

- 30 mm split clamp, black PBT bracket
- Stainless steel mounting hardware included
- Mounting hole for 30 mm sensor

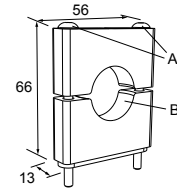

Hole center spacing: A=Ø 45
Hole size: B=Ø 27.2

SMB30S

- Swivel bracket with 30 mm mounting hole for sensor
- Adjustable captive swivel ball
- Black reinforced thermoplastic polyester
- Stainless steel mounting and swivel locking hardware included

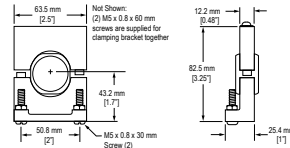

Extension Cable (without connectors)

The following cable is available for extending the length of existing sensor cable. Connectors, if used, must be customer-supplied.

Model	Type	Length	Used With:
EC900A-100	3-conductor	30 m (100 ft)	SMA912 Series ac sensors

Banner Engineering Corp. Limited Warranty

Banner Engineering Corp. warrants its products to be free from defects in material and workmanship for one year following the date of shipment. Banner Engineering Corp. will repair or replace, free of charge, any product of its manufacture which, at the time it is returned to the factory, is found to have been defective during the warranty period. This warranty does not cover damage or liability for misuse, abuse, or the improper application or installation of the Banner product.

THIS LIMITED WARRANTY IS EXCLUSIVE AND IN LIEU OF ALL OTHER WARRANTIES WHETHER EXPRESS OR IMPLIED (INCLUDING, WITHOUT LIMITATION, ANY WARRANTY OF MERCHANTABILITY OR FITNESS FOR A PARTICULAR PURPOSE), AND WHETHER ARISING UNDER COURSE OF PERFORMANCE, COURSE OF DEALING OR TRADE USAGE.

This Warranty is exclusive and limited to repair or, at the discretion of Banner Engineering Corp., replacement. **IN NO EVENT SHALL BANNER ENGINEERING CORP. BE LIABLE TO BUYER OR ANY OTHER PERSON OR ENTITY FOR ANY EXTRA COSTS, EXPENSES, LOSSES, LOSS OF PROFITS, OR ANY INCIDENTAL, CONSEQUENTIAL OR SPECIAL DAMAGES RESULTING FROM ANY PRODUCT DEFECT OR FROM THE USE OR INABILITY TO USE THE PRODUCT, WHETHER ARISING IN CONTRACT OR WARRANTY, STATUTE, TORT, STRICT LIABILITY, NEGLIGENCE, OR OTHERWISE.**

Banner Engineering Corp. reserves the right to change, modify or improve the design of the product without assuming any obligations or liabilities relating to any product previously manufactured by Banner Engineering Corp. Any misuse, abuse, or improper application or installation of this product or use of the product for personal protection applications when the product is identified as not intended for such purposes will void the product warranty. Any modifications to this product without prior express approval by Banner Engineering Corp will void the product warranties. All specifications published in this document are subject to change; Banner reserves the right to modify product specifications or update documentation at any time. Specifications and product information in English supersede that which is provided in any other language. For the most recent version of any documentation, refer to: www.bannerengineering.com.

For patent information, see www.bannerengineering.com/patents.