

# MICRO-AMP<sup>®</sup> System

## MA3 and MA3P Modulated Amplifiers



Banner MICRO-AMP<sup>®</sup> modules MA3 and MA3P are modulated amplifiers designed for use with the miniature SP100 Series remote sensors. Miniature photoelectric sensors, such as the SP100s, have traditionally been used as non-modulated devices with very limited response. These specially-engineered amplifiers bring about a dramatic improvement in the optical performance of miniature remote sensors.

MICRO-AMP modules are powered by 10 to 30 volts dc, and feature the patented Banner Alignment Indicator Device (AID<sup>™</sup>) signal strength LED. Sensor sensitivity is adjustable via a top-mounted GAIN potentiometer. Model MA3 has complementary current sinking (NPN) outputs; model MA3P has complementary current sourcing (PNP) outputs. Circuitry is epoxy-encapsulated and enclosed in a tough molded VALOX<sup>®</sup> housing. Connections may be made to the MICRO-AMP via the optional RS8 socket/wiring base, or the module may be mounted directly to a printed circuit board (see page 3).

The small size and the slim ribbon-style connecting cable of SP100 Series sensors make it possible to use photoelectrics in many situations previously thought to be impractical or even impossible.



### MICRO-AMP<sup>®</sup> Model MA3 Specifications

**SUPPLY VOLTAGE:** 10 to 30V dc at less than 20 milliamps (exclusive of load); 10% maximum ripple.

**OUTPUT CONFIGURATION:** two open-collector NPN (current sinking) transistor (solid-state) switches; one normally open (light operate) and one normally closed (dark operate); 150 milliamps maximum, each output. Saturation voltage less than 0.5V dc at 10 milliamp load. Off-state leakage current less than 1 microamp.

**RESPONSE SPEED:** 1 millisecond ON and OFF.

**REPEATABILITY:** 0.3 millisecond.

**SENSOR LEAD LENGTH:** 15 feet (4,5 m) maximum.

**ADJUSTMENT:** GAIN adjustment (single-turn potentiometer; adjust with small flat-blade screwdriver).

**INDICATOR:** exclusive Banner Alignment Indicator Device (AID<sup>™</sup>) system lights a red LED indicator whenever the sensor "sees" its own modulated light source, and pulses at a rate proportional to the strength of the received light signal.

**CONSTRUCTION\*:** totally encapsulated plug-in package with molded VALOX<sup>®</sup> housing. Gold-flashed connection pins.

**OPERATING TEMPERATURE:**  
0 to +70 degrees C (32 to +158 degrees F).

\*A Dimension Drawing appears on page 3.

### Functional Schematic, MA3 Amplifier

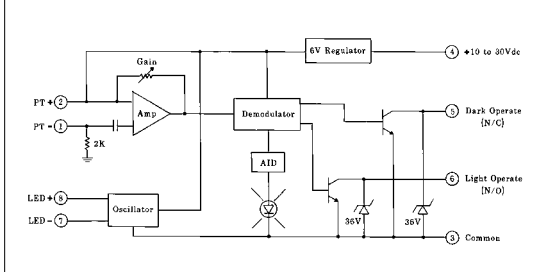

### Hookup Diagram, MA3 Amplifier

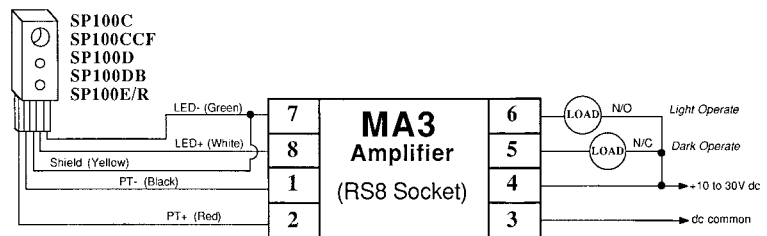

### Model MA3P: PNP (current sourcing) output

Model MA3P has the same specifications and performance as the MA3 amplifier, except that the MA3P has complementary PNP outputs in place of the MA3's NPN configuration.

**OUTPUT:** two PNP transistors, complementary outputs; one normally open (light operate) and one normally closed (dark operate). 150 milliamps maximum, each output. Saturation voltage is less than 1V dc at 10 milliamps. Off-state leakage current is less than 1 microamp.

### Hookup Diagram, MA3P Amplifier

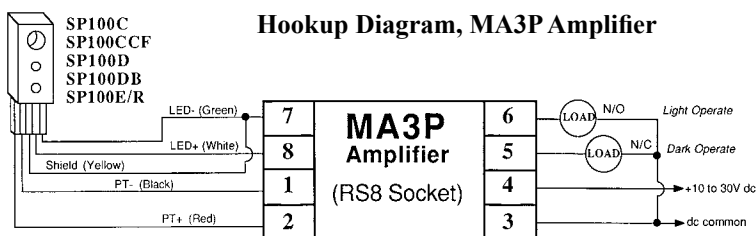

# Sensors for use with MA3 and MA3P Modulated Amplifiers

Temperature range for all miniature modulated remote sensors is 0 to 70 degrees C (+32 to 158 degrees F).  
Sensors are epoxy-encapsulated and optics are hermetically sealed.

## Models/Dimensions

## Excess Gain

## Beam Pattern



### SP100E & SP100R

**Range:** 8 inches (20cm)  
**Beam:** infrared, 880nm  
**Effective beam:** .05 inch (1,3mm diameter)

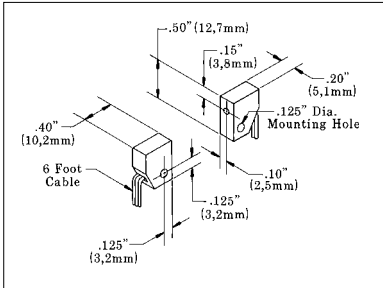

**Cable (all 6-foot lengths):**  
 SP100E: 2-wire ribbon cable (white, green).  
 SP100R: 3-wire ribbon cable (red, black, yellow).

SP100D, DB, C, CCF: 5-wire ribbon cable (white, green, red, black, yellow). See hookup drawing.

### OPPOSED Mode Sensors

SP100E and SP100R miniature opposed sensors have a slim right-angle design which allows them to be mounted in very tight locations. The thin, flexible ribbon cable which exits from one corner may be run in any direction away from the sensing point. The SP100E and R have a wide beam angle for forgiving line-of-sight alignment. Alignment is easily made exact (and monitored) using the AID™ LED on the MICRO-AMP module.

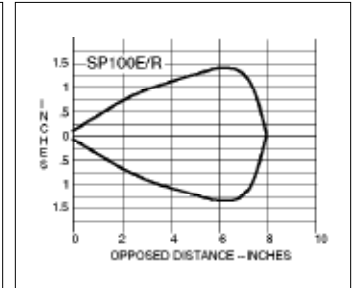
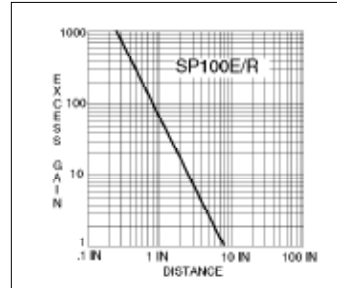

### SP100D

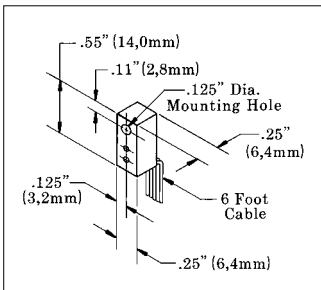
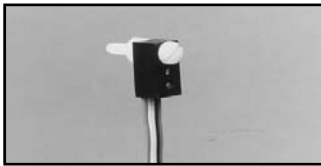

### SP100DB

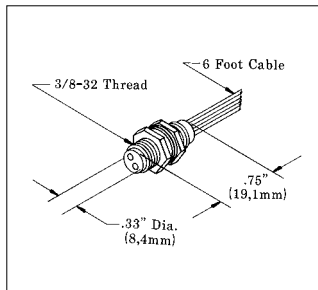
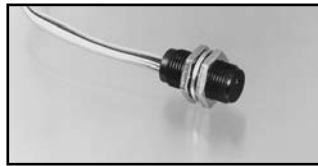

### DIFFUSE Mode Sensors

Models SP100D and SP100DB are general-purpose miniature diffuse sensors which detect the reflection of their own light from the surface of an object. The SP100D is a right-angle design which is generally held in place using a #4 (3mm) screw. The SP100DB ("B" = Barrel) is an in-line threaded barrel which typically mounts through a 3/8" (10mm) diameter hole using the lock nuts which are supplied. The optical response characteristics of these two sensors are identical.

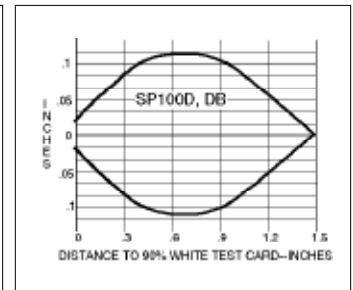
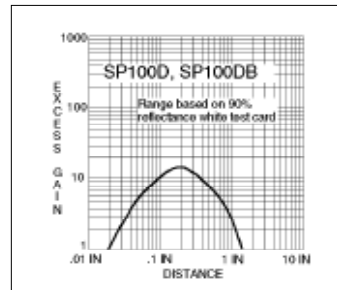

### SP100C

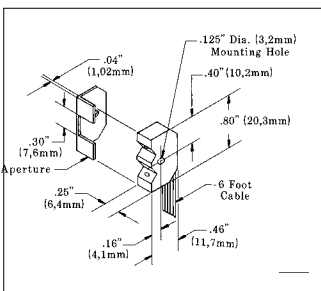
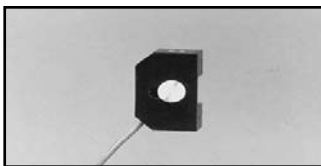

### SP100CCF

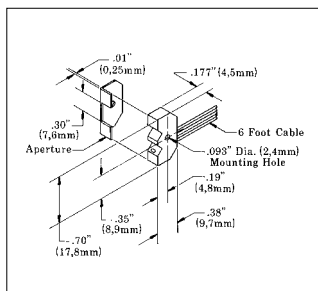
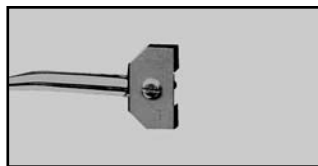

### CONVERGENT Mode Sensors

Models SP100C and CCF are ideally suited to applications where depth of field is critical. The emitter and receiver are both directed at a point 0.1 inch (2,5mm) ahead of the front surface. An aperture is included which, when attached, narrows the depth of field (see curves, below). This is particularly useful when it is necessary to detect an object while ignoring another object or a surface just a fraction of an inch farther away. The high excess gain at the focus allows detection of objects of low reflectivity. The SP100C and CCF differ only in housing style. Model SP100C is for general application. Model SP100CCF is used where a narrow profile is important for mounting.

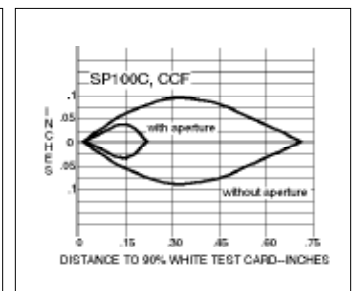
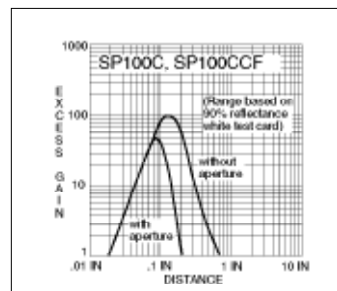

# MICRO-AMP® System Accessories

## RS8 Socket

The RS8 socket is the most frequently used means of mounting and wiring a MICRO-AMP module. It consists of a socket with two four-terminal connection strips, all wired together onto a PC board. The PC board assembly slides into a 1 inch (25mm) long PVC track which is used to mount the entire assembly. A hold-down screw keys the correct polarity of the module.



## Dimensions, MA3 and MA3P, shown with RS8 Wiring Socket

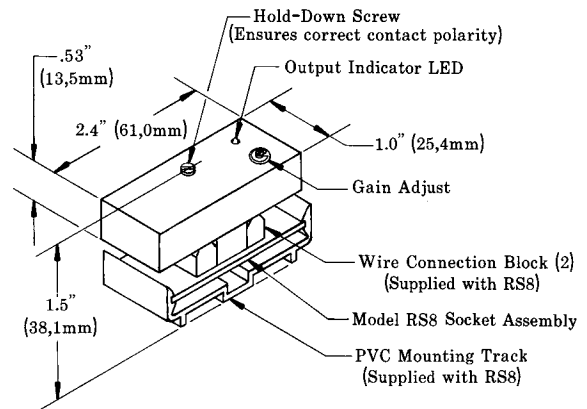

## RS8K Socket

The RS8K is a kit of parts that comprise the socket portion of the RS8 assembly. It is used to provide a socket for MICRO-AMP modules that are installed onto printed circuit boards. The RS8K consists of a molded socket block and 8 individual socket pins. A nylon screw is included to affix the socket block to the PC board. The drill size for the pins is #50 (.070"; 1,8mm). Drill pattern dimensions are included.

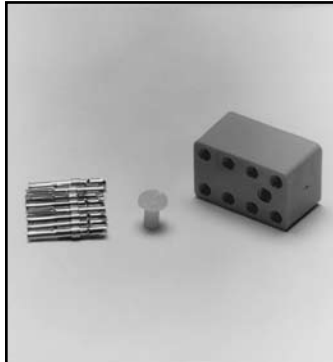

MICRO-AMP® module pin configuration.

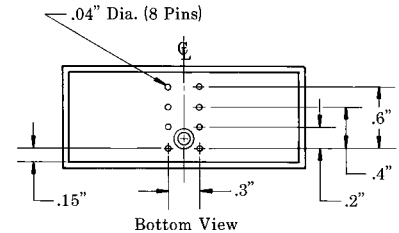

## Mounting Track

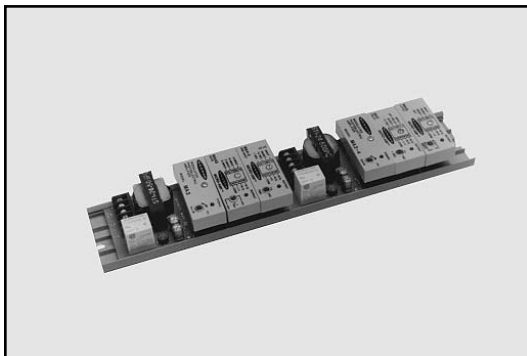

- TR100-1** 1 inch (25mm) long (supplied with RS8 socket)
- TR100-4** 4 inch (100mm) long (supplied with MPS-15 series power supply)
- TR100-6** 6 inch (150mm) long
- TR100-12** 12 inch (300mm) long

PVC mounting track for MICRO-AMP components is available in 6 and 12 inch lengths for systems which use multiple components. For example, a 6-inch length will accommodate one MPS-15 power supply plus two additional RS8 sockets with modules.

Longer lengths of mounting track may be supplied on a quote basis.

## Dimensions, TR-100 Mounting Track

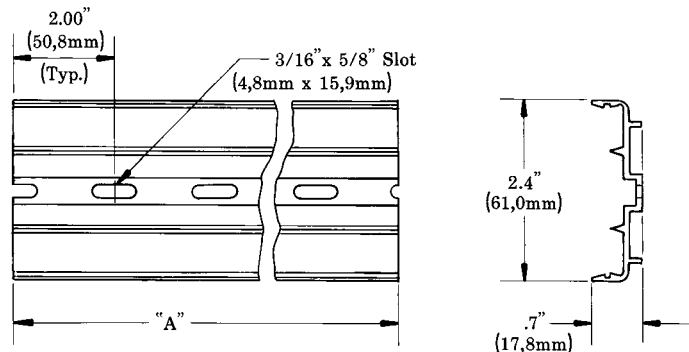

| Track Model | "A" Dimension | Minimum number of slots |
|-------------|---------------|-------------------------|
| TR100-1     | 1" (25mm)     | 1                       |
| TR100-4     | 4" (10cm)     | 2                       |
| TR100-6     | 6" (15cm)     | 3                       |
| TR100-12    | 12" (30cm)    | 8                       |

# MPS-15 and MPS-15-230 Power Supplies

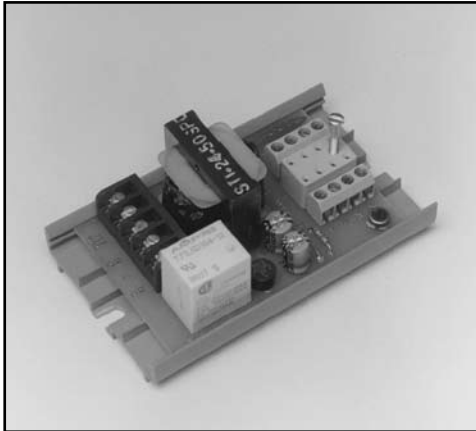

The **MPS-15 Series** power supplies are designed specifically to supply power for the Banner MICRO-AMP series amplifiers and logic modules. They are constructed on small PC boards that are track-mountable for compatibility with other track-mounted MICRO-AMP components. The MPS-15 includes a socket for a MICRO-AMP amplifier or logic module having **current sinking (NPN) output\***. The combination of an MPS-15 series power supply and a MICRO-AMP module makes a complete and compact sensing and/or control system.

A built-in 5-amp rated SPDT output relay is supplied for easy interfacing to an external load or circuit. Its action is controlled by the outputs of a MICRO-AMP module which is plugged into the on-board module socket\*. A switch on the PC board selects which module output (normally open or normally closed) will activate the relay.

Two models are available. Model MPS-15 is for 120V ac operation. Model MPS-15-230 is for 220/240V ac power. Up to three MICRO-AMP modules may be powered by one MPS-15 or MPS-15-230 power supply. A 4-inch (10cm) long mounting track is included with each supply. Optional 6-inch (15cm) track model TR100-6 neatly accommodates the MPS-15 Series PC board plus the PC boards of two additional RS8 sockets to form a complete three-module MICRO-AMP sensing/logic system. (See Mounting Track information, page 3.)

\*Do **not** plug MICRO-AMP modules with PNP (current sourcing) outputs ("P" suffix) into the socket on the MPS-15 or MPS-15-230 power supply.

## Other MICRO-AMP® Modules

| Module Model                                 | Modulated Amplifier   | Logic Functions                     | Used with (Input)  | Full Description                   |
|--|---|-------------------------------------|--|------------------------------------|
| MA3A   | YES   | NONE (ON/OFF)                       | Banner SP100FF modulated fixed-field sensor  | Banner catalog or data sheet 03523 |
| MA3-4 and MA3-4P                             | YES   | NONE (ON/OFF)                       | Banner high-performance remote sensors   | Banner catalog or data sheet 03341 |
| MA4-2  | MICRO-AMP logic modules are designed to accept the output signal from a MICRO-AMP amplifier and process that signal for a required logic function. MICRO-AMP logic modules themselves contain no amplifier. | ONE-SHOT                            | Switches, contacts, or NPN (current sinking) output of dc sensors or amplifiers, including: Banner MULTI-BEAM, MAXI-BEAM, VALU-BEAM, MINI-BEAM, and ECONO-BEAM sensors; plus MAXI-AMP and MICRO-AMP modules. | Banner catalog or data sheet 03350 |
| MA4G   |   | 4-input logic gate: AND, NOR, X-NOR |  | Banner catalog or data sheet 03351 |
| MA4L   |   | Latch or alternate-action flip-flop |  | Banner catalog or data sheet 03352 |
| MA5  |   | ON-delay or OFF-delay               |  | Banner catalog or data sheet 03353 |
| MPC3<br>(for printed circuit board mounting) | YES   | NONE (ON/OFF)                       | Banner SP100 Series miniature modulated remote sensors   | Banner catalog or data sheet 03336 |



**WARNING** MICRO-AMP® Systems do NOT include the self-checking redundant circuitry necessary to allow their use in personnel safety applications. A sensor or amplifier failure or malfunction can result in either an energized or a de-energized output condition.

Never use this product as a sensing device for personnel protection. Its use as a safety device may create an unsafe condition which could lead to serious injury or death.

Only MACHINE-GUARD and PERIMETER-GUARD Systems, and other systems so designated, are designed to meet OSHA and ANSI machine safety standards for point-of-operation guarding devices. No other Banner sensors or controls are designed to meet these standards, and they must NOT be used as sensing devices for personnel protection.

**WARRANTY:** Banner Engineering Corporation warrants its products to be free from defects for one year. Banner Engineering Corporation will repair or replace, free of charge, any product of its manufacture found to be defective at the time it is returned to the factory during the warranty period. This warranty does not cover damage or liability for the improper application of Banner products. This warranty is in lieu of any other warranty either expressed or implied.