

ISOMETRIC VIEW
SCALE 1:1

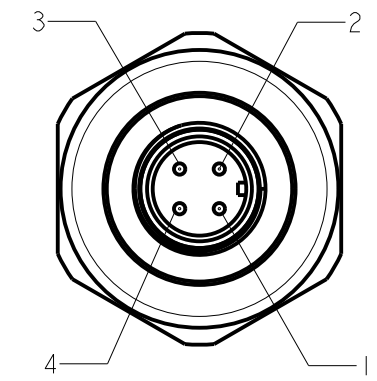

MALE POLES

- 1. SUPPLY V+
- 2. OUTPUT
- 3. N/C
- 4. N/C

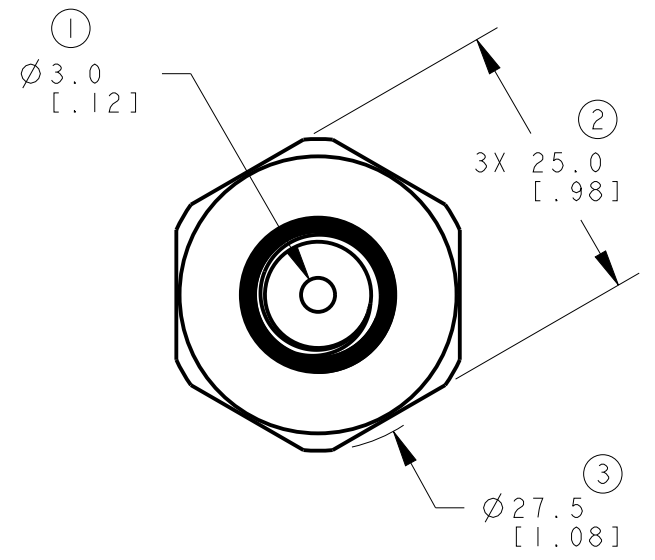
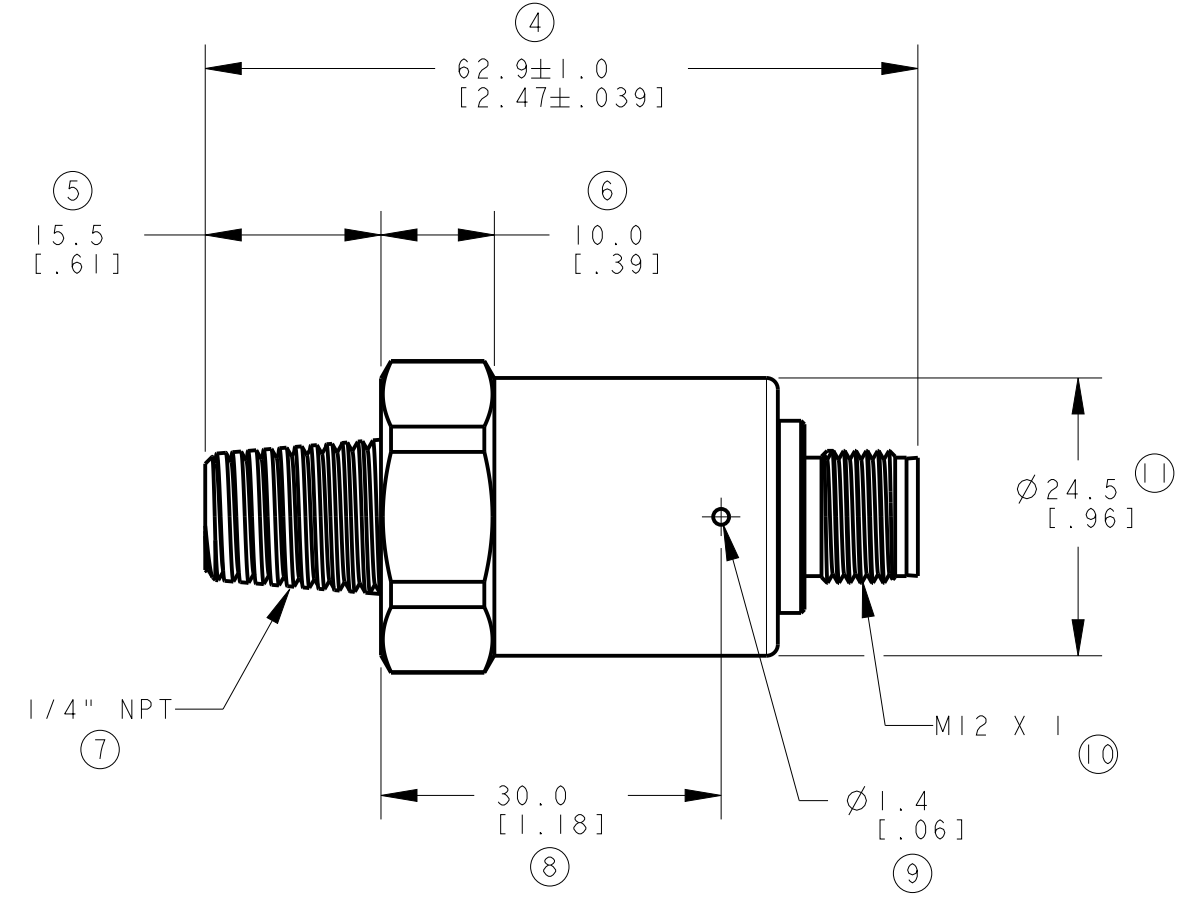

This drawing is the property of BANNER ENGINEERING CORP. Any use or reproduction, in any form, without prior written permission of Banner is prohibited. © 2015 Banner Engineering Corp.



BANNER ENGINEERING CORP.
www.bannerengineering.com

THIRD ANGLE PROJECTION

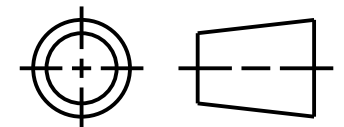

TITLE
PRESSURE SENSOR 50PSI 4-20MA STAINLESS

SIZE B	DRAWING NO. 236418	REV. A
SCALE 3:2	SHEET 1 OF 1	

NOTES:
1. ALL DIMENSIONS ARE MILLIMETERS [INCHES] UNLESS OTHERWISE NOTED.
2. REFER TO "www.bannerengineering.com" FOR ADDITIONAL DATA AND SPECIFICATIONS.