

8 7 6 5 4 3 2 1

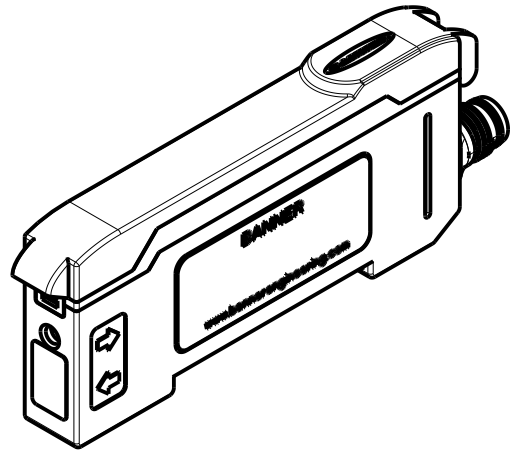
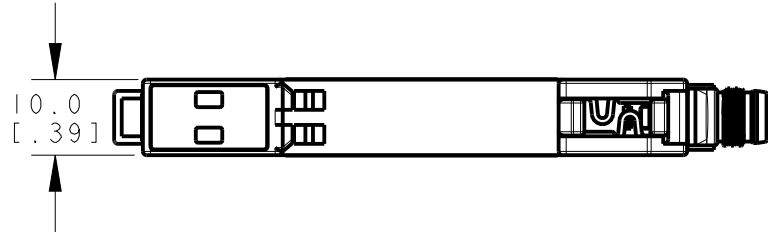
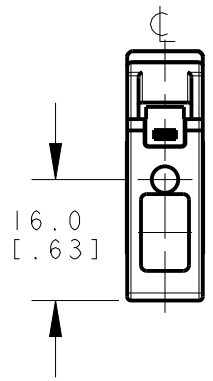
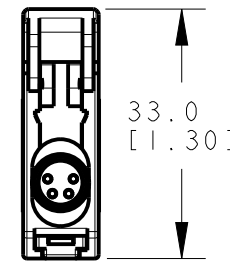
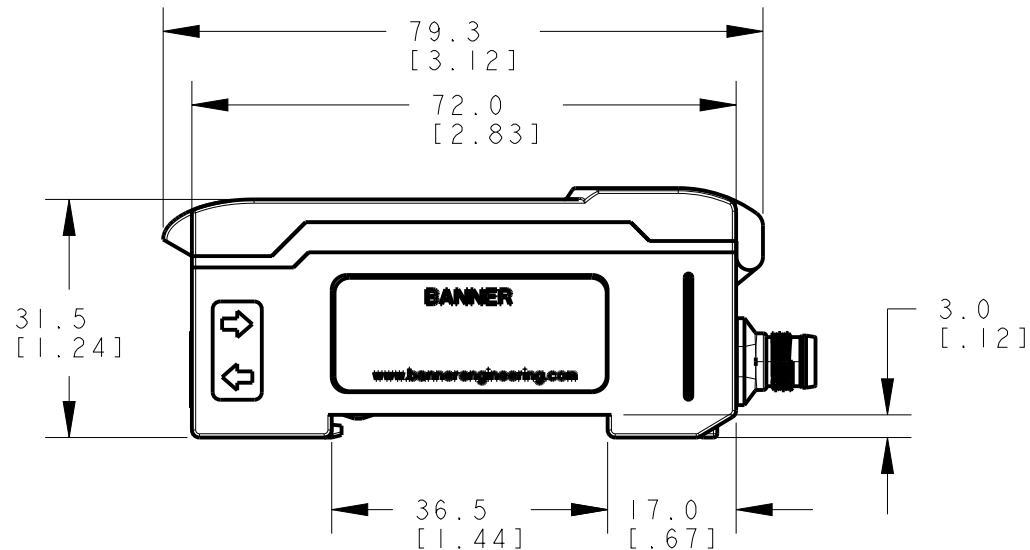
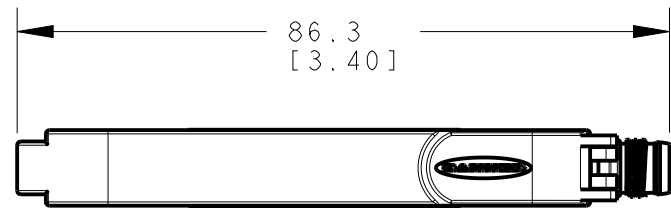

This drawing is the property of BANNER ENGINEERING CORP. and is proprietary in general and in detail. Its contents shall not be revealed to outside parties without written consent of BANNER.

**BANNER** ENGINEERING CORP.  
P.O. BOX 9414  
MINNEAPOLIS, MN 55440

THIRD ANGLE PROJECTION

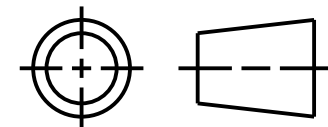

TITLE

**DF-GI RECEIVER OD**

SIZE B	DRAWING NO. <b>177887</b>	REV. <b>A</b>
-----------	------------------------------	------------------

SCALE 1:1	SHEET 1 OF 1
--------------	-----------------

NOTES:  
1. ALL DIMENSIONS ARE MILLIMETERS [INCHES] UNLESS OTHERWISE NOTED.

8 7 6 5 4 3 2 1

PRO/E