

8

7

6

5

4

3

2

1

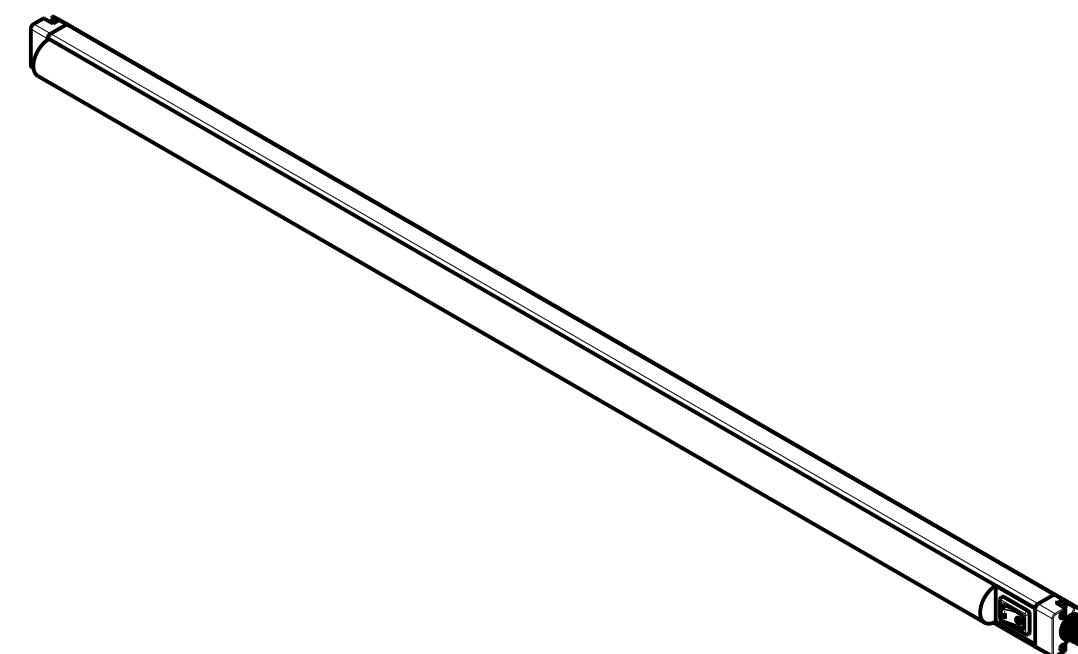
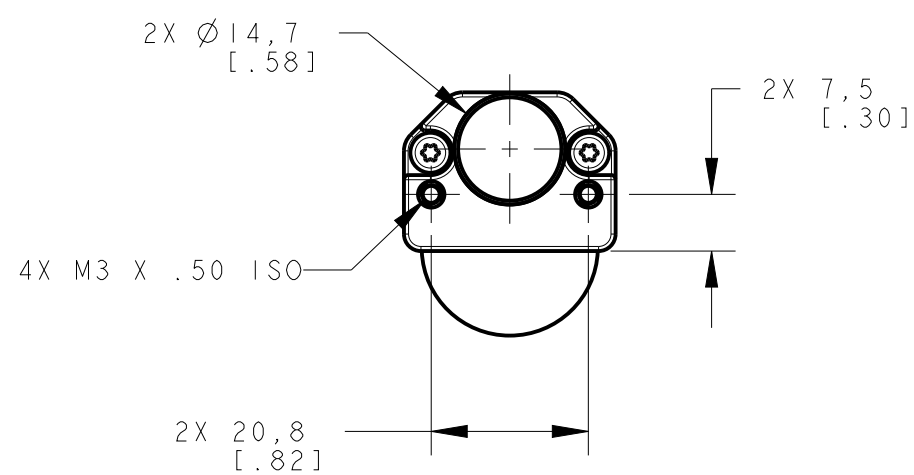

ISOMETRIC VIEW
SCALE 1:4

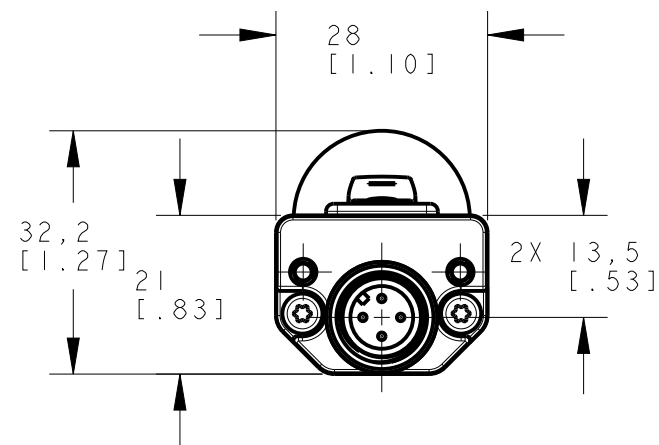
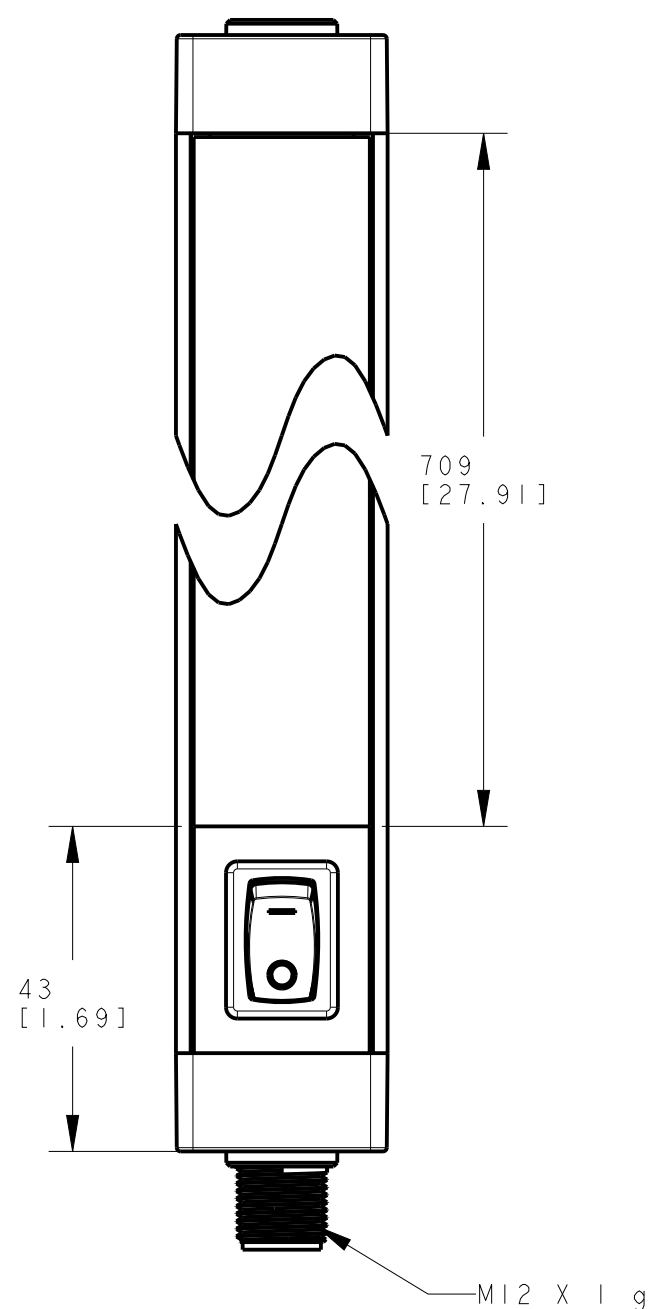
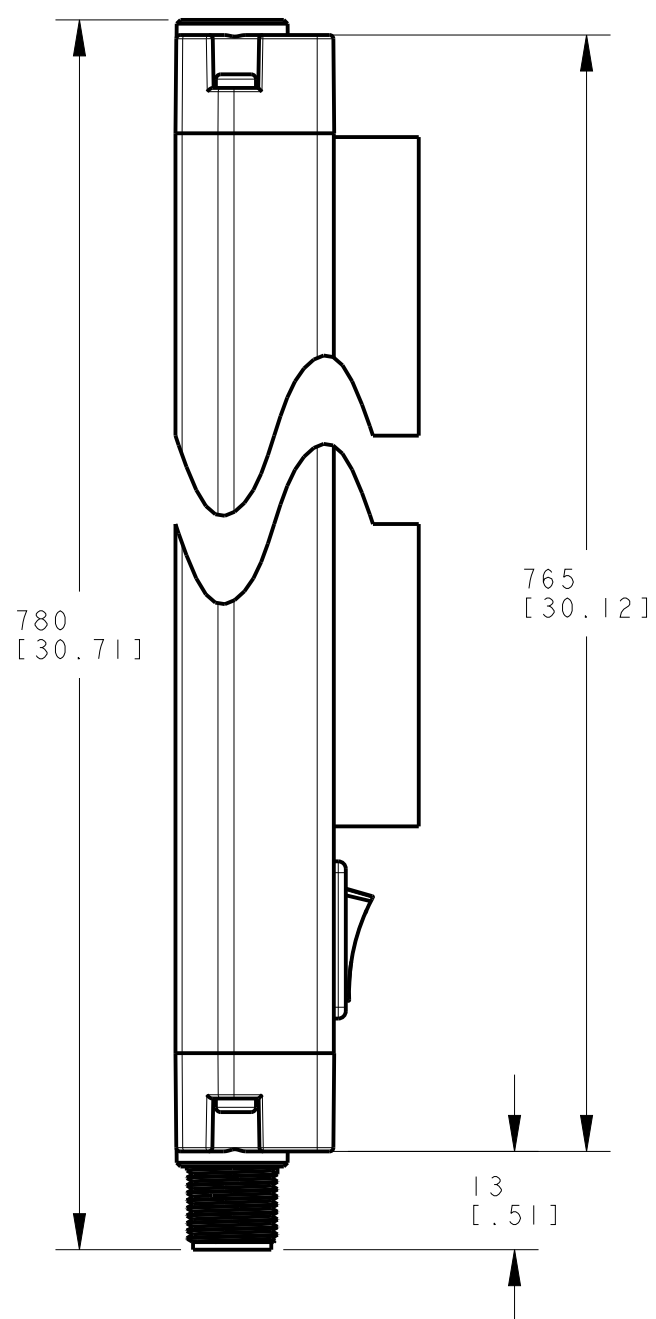

NOTES:
1. ALL DIMENSIONS ARE MILLIMETERS [INCHES] UNLESS OTHERWISE NOTED.

This drawing is the property of BANNER ENGINEERING CORP. and is proprietary in general and in detail. Its contents shall not be revealed to outside parties without written consent of BANNER.

BANNER BANNER ENGINEERING CORP.
P.O. BOX 9414
MINNEAPOLIS, MN 55440

THIRD ANGLE PROJECTION

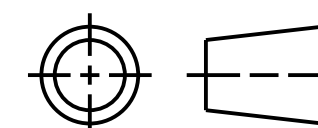

TITLE		
WLS28X710L25XPBO		
SIZE C	DRAWING NO. 177630	REV. A
SCALE 1:1	SHEET 1 OF 1	

8

7

6

5

4

3

2

1

PRO/E