

8 | 7 | 6 | 5 | 4 | 3 | 2 | 1

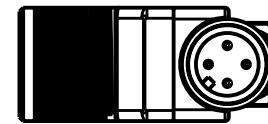
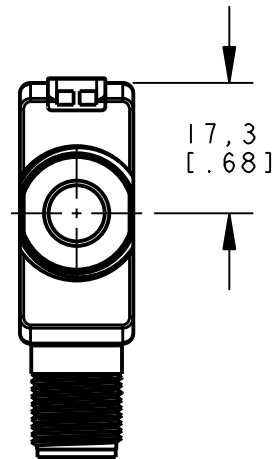
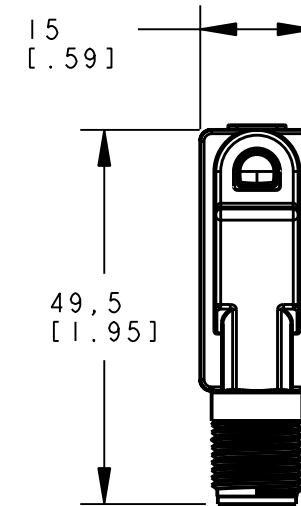
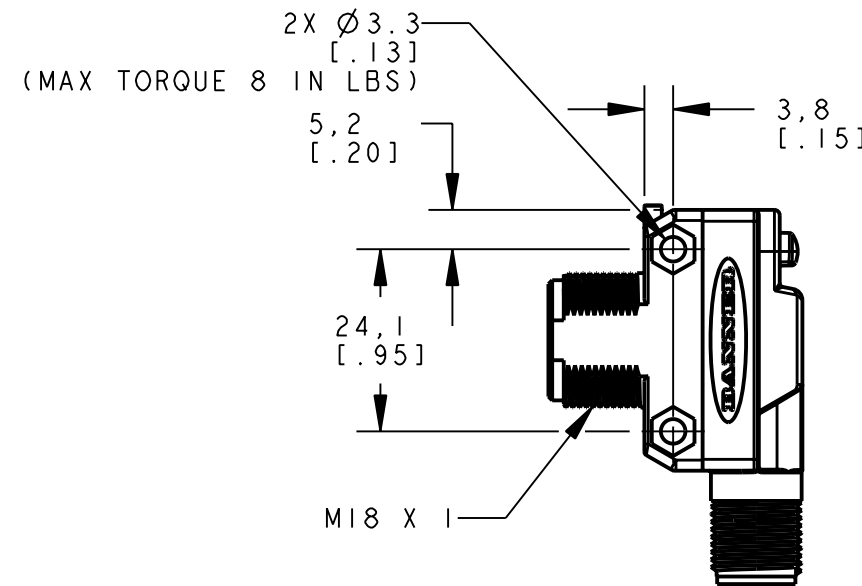
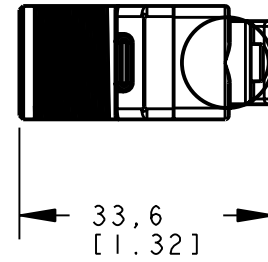
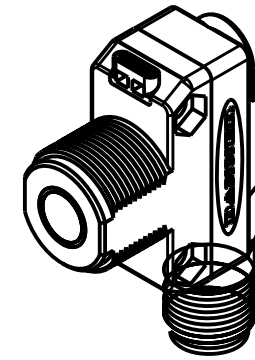

This drawing is the property of BANNER ENGINEERING CORP. and is proprietary in general and in detail. Its contents shall not be revealed to outside parties without written consent of BANNER.

**BANNER** BANNER ENGINEERING CORP.  
P.O. BOX 9414  
MINNEAPOLIS, MN 55440

THIRD ANGLE PROJECTION

TITLE  
**OS18U EXPERT EURO OD  
WEB CAD DRAWINGS 2D/3D**

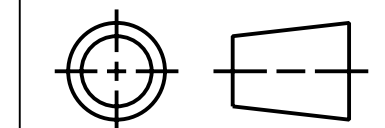

SIZE B DRAWING NO. **148175** REV. **A**

NOTES:  
1. ALL DIMENSIONS ARE MILLIMETERS [INCHES] UNLESS OTHERWISE NOTED.

SCALE 1:1 SHEET 1 OF 1

8 | 7 | 6 | 5 | 4 | 3 | 2 | 1 | PRO/E