

SCALE 1:4

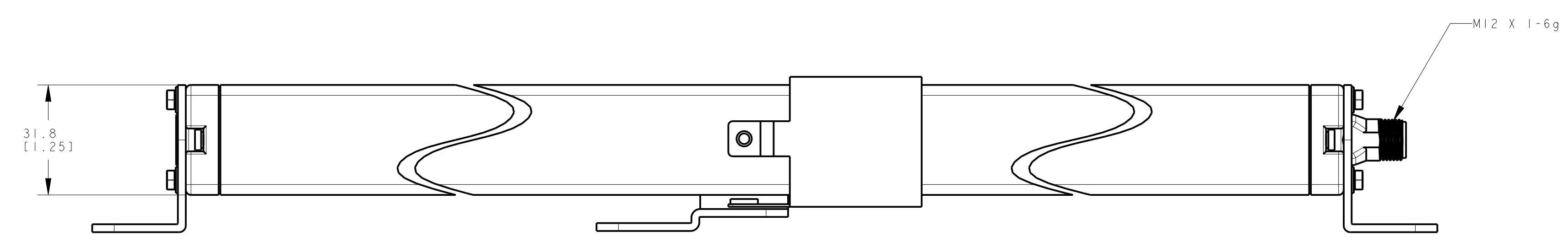
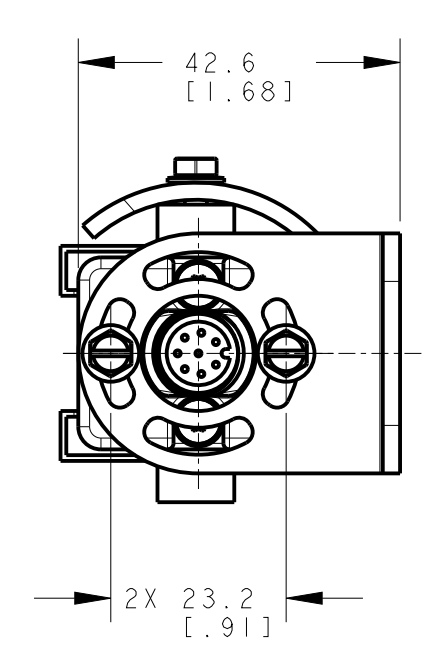
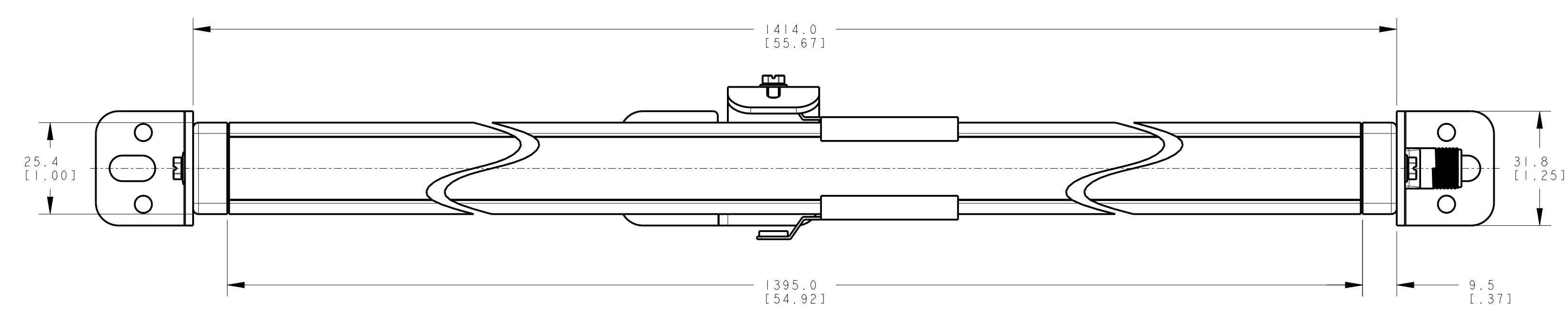
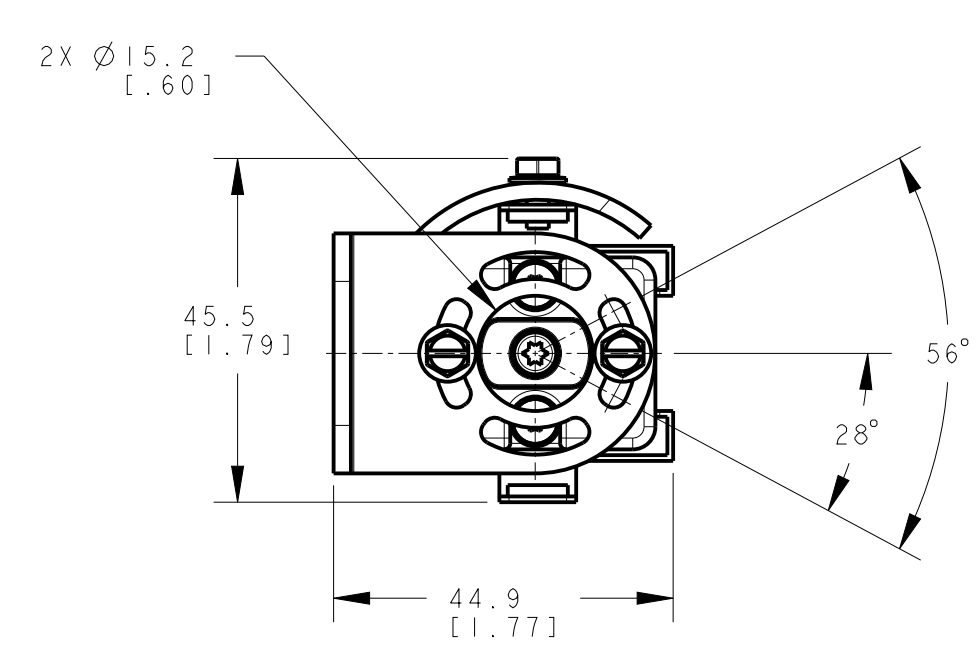
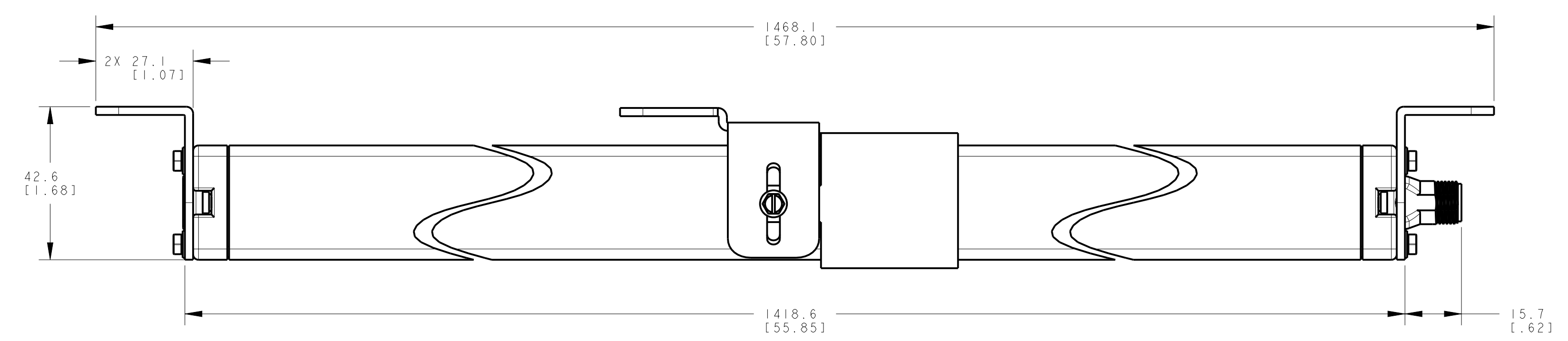
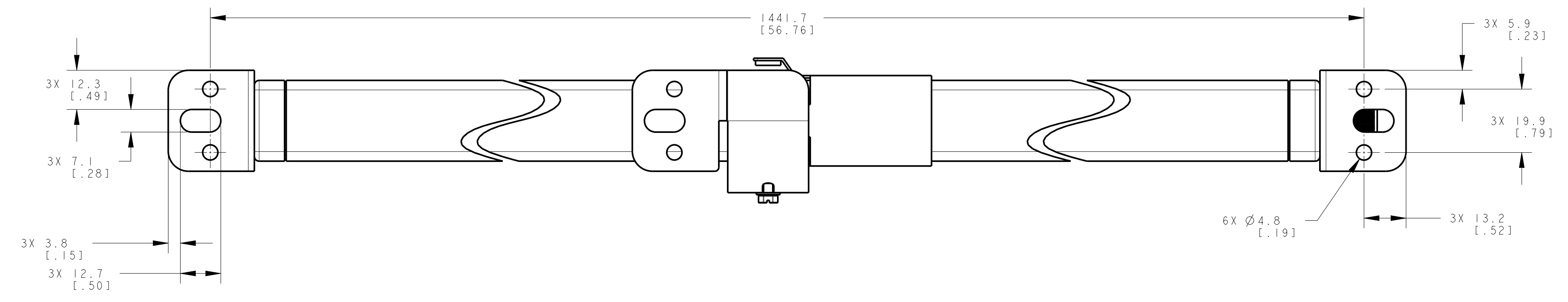

NOTES:
 1. ALL DIMENSIONS ARE MILLIMETERS [INCHES] UNLESS OTHERWISE NOTED.
 2. REFER TO "www.bannerengineering.com" FOR ADDITIONAL DATA AND SPECIFICATIONS.

This drawing is the property of BANNER ENGINEERING CORP. Any use or reproduction, in any form, without prior written permission of Banner is prohibited.
 © 2015 Banner Engineering Corp.

BANNER BANNER ENGINEERING CORP.
 www.bannerengineering.com

TITLE
EZ-SCREEN Type 2, LS2 1350mm OD

THIRD ANGLE PROJECTION

SIZE D	DRAWING NO. 139573	REV. A
SCALE 1:1	SHEET 1 OF 1	

CREO