



TM18 Series Sensors



Self-contained dc-operated photoelectric sensors in a robust metal housing



Features

- Robust die-cast nickel-plated housing with sealed membrane switch is designed to meet IEC IP67 requirements
- Excellent immunity to noise, including high-speed-switching fluorescent lamps and EMI (electromagnetic interference)
- Simple single-button setup procedure
- Selectable light operate/dark operate (push-button toggle)
- Models with selectable NPN or PNP operation (see hookups) or dedicated single NPN or PNP output; 300mA current rating
- Enhanced optical crosstalk avoidance

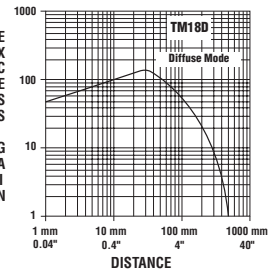
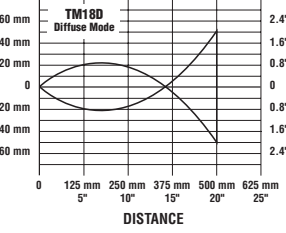
Models

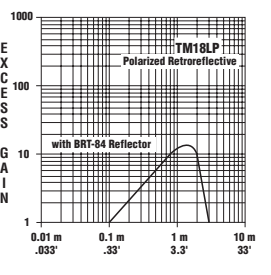
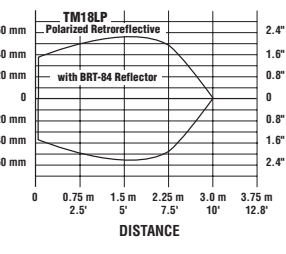
Sensing Range	Model	Range	Cable*	Output	Excess Gain	Beam Pattern
					Data taken at 25° C	
Diffuse 	880 nm Infrared	500 mm (19")	2 m (6.5') 4-wire PVC cable	Selectable NPN or PNP		
	TM18BM6D					
	TM18N6DQP					
	TM18P6DQP			PNP		
Polarized Retroreflective 	660 nm Visible Red	3 m (10') See Note (1)	2 m (6.5') 4-wire PVC cable	Selectable NPN or PNP		
	TM18BM6LP					
	TM18N6LPQP					
	TM18P6LPQP			PNP		

*For selectable NPN/PNP models, other cable/connector options are available:

- **9 m cable:** add suffix "W/30" to the model number (e.g., **TM18BM6D W/30**)
- **4-pin Euro-style integral QD:** add suffix "Q" to the model number (e.g., **TM18BM6DQ**)

(1) Retroreflective range is specified using one model BRT-84 reflector. Actual sensing range may be more or less than specified, depending upon efficiency and reflective area of the reflector(s) in use. For example, using a BRT-92x92C reflector will increase range to 5 m.



WARNING . . . Not To Be Used for Personnel Protection

Never use these products as sensing devices for personnel protection. Doing so could lead to serious injury or death.

These sensors do NOT include the self-checking redundant circuitry necessary to allow their use in personnel safety applications. A sensor failure or malfunction can cause either an energized or de-energized sensor output condition. Consult your current Banner Safety Products catalog for safety products which meet OSHA, ANSI and IEC standards for personnel protection.

TM18 Series Sensors – Self-Contained Photoelectric Sensors in a Metal Housing

Sensor Configuration

Configuring the TM18 sensor is easy, using one push-button switch on the sensor housing. Set the sensor for application sensing conditions using Dark SET, or toggle between Light Operate or Dark Operate sensing with the same button.

Dark SET allows the sensor to maximize the signal-to-noise ratio without setting multiple targets. With Dark SET, the sensor learns the darkest condition. For diffuse models, this is typically the area behind the object to be sensed. For LP models, this is typically the object to be sensed.

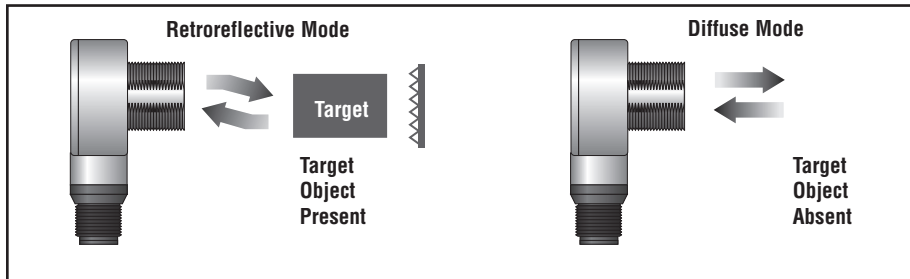

Figure 1. Dark sensing condition

Dark SET Procedure

- **Diffuse mode:** Remove object to be sensed from sensor's field of view.
- **Retroreflective mode:** Place object to be sensed between the retroreflector and the sensor.
- Press push button approximately 2 seconds; Signal LED flashes yellow/green.
- Release button; LED stops flashing when programming is complete.

Light Operate/Dark Operate Select

Select Light Operate (output conducts when object is present) or Dark Operate (output conducts when object is absent) using the push button to toggle between the selections. Toggling the sensing mode does not affect the sensor's gain.

- Press push button approximately 10 seconds; release push button.
- Signal LED flashes yellow/green, followed by 5 flashes of 1 color to designate current selection:
5 green flashes = Light Operate
5 yellow flashes = Dark Operate

Sensor Condition	Power LED	Signal LED
RUN Mode		
Signal Absent	ON	OFF
Signal Present	ON	Yellow
SET Mode	ON	Flashes yellow/green during configuration
Toggled to Light Operate	ON	Final 5 flashes – green
Toggled to Dark Operate	ON	Final 5 flashes – yellow

Figure 2. Indicator status during RUN and TEACH modes

TM18 Series Sensors – Self-Contained Photoelectric Sensors in a Metal Housing

Specifications

Supply Voltage	10 to 30V dc (10% maximum ripple) at less than 40 mA, exclusive of load Protected against reverse polarity and transient voltages
Output Configuration	Solid-state selectable models: NPN or PNP (current sinking or sourcing); depending on hookup Dedicated single-output models: NPN or PNP (current sinking or sourcing); depending on model Rating: 300 mA maximum output at 25°C Off-state leakage current: NPN less than 100 µA @ 30V dc PNP less than 300 µA @ 30V dc ON-state saturation voltage: less than 1V @ 10 mA; less than 1.5V @ 300 mA Protected against false pulse on power-up and continuous overload or short circuit of outputs
Output Response	3 milliseconds ON/OFF NOTE: 300 millisecond delay on power-up; outputs do not conduct during this time
Repeatability	300 microseconds maximum
Adjustments	Push-button dark SET, light/dark operate toggle NPN/PNP selected via hookup
Indicators	2 LED indicators: Power ON/OFF (green) Signal (bi-color yellow/green)
Construction	Copper/nickel-plated zinc alloy housing; rated IEC IP67; NEMA 6
Connections	2 m (6.5') 4-wire PVC cable, 9 m (30') PVC cable, 4-pin Euro-style integral QD, or 4-pin Euro-style 150 mm (6") polyurethane pigtail QD, depending on model (see model listing on page 1)
Operating Conditions	Temperature: -20° to +55° C (-4° to +132° F) Relative Humidity: 90% @ 50° C (non-condensing)
Certifications	

Dimensions and Features

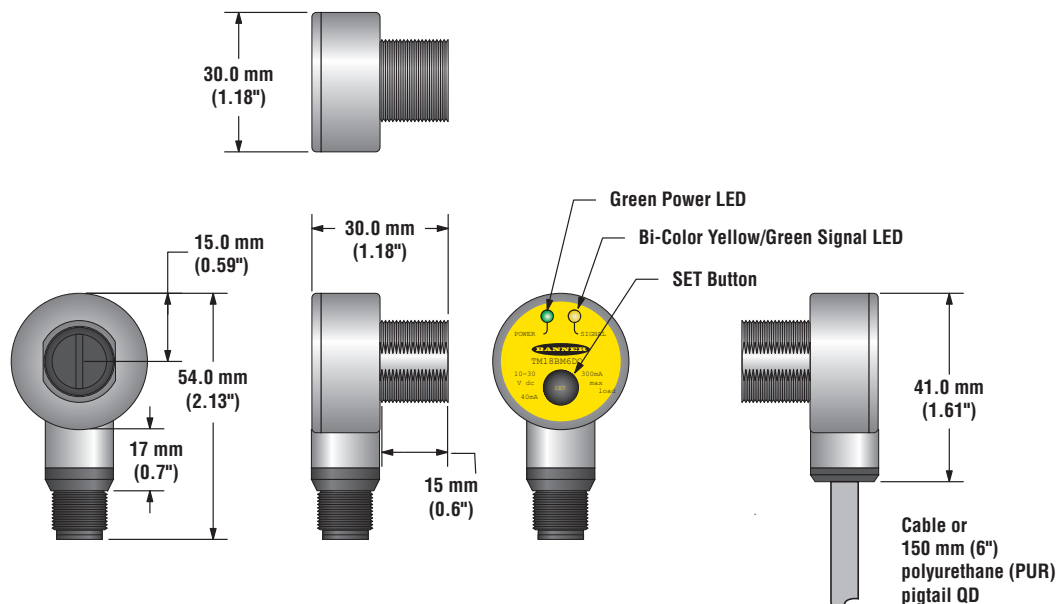

TM18 Series Sensors – Self-Contained Photoelectric Sensors in a Metal Housing

Hookups

Selectable-Output Models

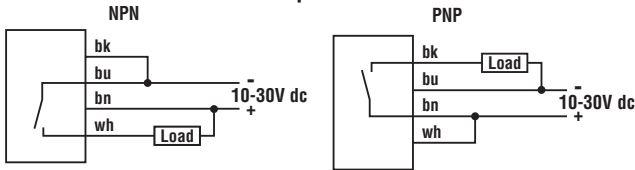

Dedicated-Output Models

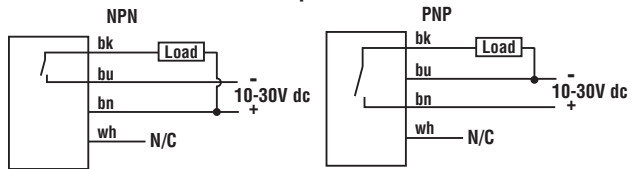

NOTE: QD model hookups are functionally identical.

Accessories

Quick-Disconnect Cables

Style	Model	Length	Dimensions
4-pin straight	MQDC-406	2 m (6.5')	
	MQDC-415	5 m (15')	
	MQDC-430	9 m (30')	
4-pin right-angle	MQDC-406RA	2 m (6.5')	
	MQDC-415RA	5 m (15')	
	MQDC-430RA	9 m (30')	

SMBT18Y

- Die-cast bracket
- Accommodates Euro-style QD connectors and cabled sensor models

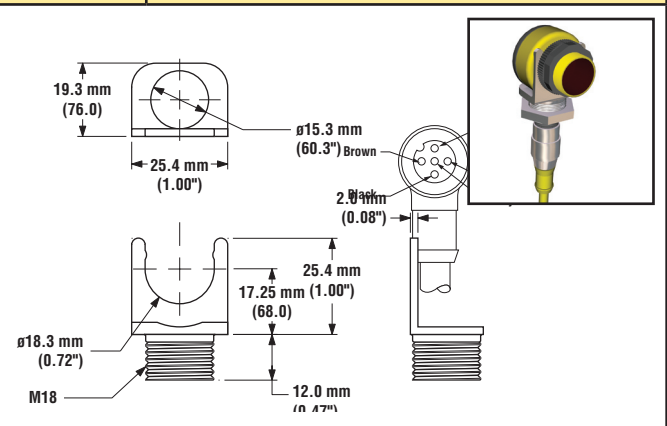

more sensors, more solutions

Banner Engineering Corp Limited Warranty

Banner Engineering Corp. warrants its products to be free from defects in material and workmanship for one year following the date of shipment. Banner Engineering Corp. will repair or replace, free of charge, any product of its manufacture which, at the time it is returned to the factory, is found to have been defective during the warranty period. This warranty does not cover damage or liability for misuse, abuse, or the improper application or installation of the Banner product.

THIS LIMITED WARRANTY IS EXCLUSIVE AND IN LIEU OF ALL OTHER WARRANTIES WHETHER EXPRESS OR IMPLIED (INCLUDING, WITHOUT LIMITATION, ANY WARRANTY OF MERCHANTABILITY OR FITNESS FOR A PARTICULAR PURPOSE), AND WHETHER ARISING UNDER COURSE OF PERFORMANCE, COURSE OF DEALING OR TRADE USAGE.

This Warranty is exclusive and limited to repair or, at the discretion of Banner Engineering Corp., replacement. IN NO EVENT SHALL BANNER ENGINEERING CORP. BE LIABLE TO BUYER OR ANY OTHER PERSON OR ENTITY FOR ANY EXTRA COSTS, EXPENSES, LOSSES, LOSS OF PROFITS, OR ANY INCIDENTAL, CONSEQUENTIAL OR SPECIAL DAMAGES RESULTING FROM ANY PRODUCT DEFECT OR FROM THE USE OR INABILITY TO USE THE PRODUCT, WHETHER ARISING IN CONTRACT OR WARRANTY, STATUTE, TORT, STRICT LIABILITY, NEGLIGENCE, OR OTHERWISE.

Banner Engineering Corp. reserves the right to change, modify or improve the design of the product without assuming any obligations or liabilities relating to any product previously manufactured by Banner Engineering Corp.