

## Instruction Manual

### Miniature Self-Contained Photoelectric Sensors in Universal Housing

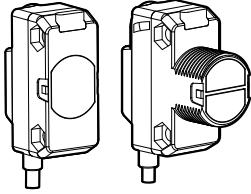

- Easily fits (or retrofits) almost any mounting situation
- Exceptional optical performance, comparable to larger “MINI-style” or barrel sensors
- 10 V dc to 30 V dc operation, with complementary (SPDT) NPN or PNP outputs, depending on model
- Bright LED operating status indicators are visible from 360°
- Rugged sealed housing, protected circuitry
- Models available with or without 18 mm threaded “nose”
- Less than 1 millisecond output response for excellent sensing repeatability
- Choose 2 m (6.5 ft) or 9 m (30 ft) cable or 150 mm (6 inch) Pico-style cabled QD



#### WARNING: Not To Be Used for Personnel Protection









Never use this device as a sensing device for personnel protection. Doing so could lead to serious injury or death. This device does not include the self-checking redundant circuitry necessary to allow its use in personnel safety applications. A sensor failure or malfunction can cause either an energized or de-energized sensor output condition.

## Models

Model <sup>1</sup>	Opposed Mode	Range	Output
QS186EV (624 nm Visible red)	Effective beam: 13 mm (0.5 inch) 	20 m (66 ft)	—
QS186E (940 nm Infrared)			—
QS18VN6R			NPN
QS18VP6R			PNP
QS186EB (940 nm Infrared)	Effective beam: 13 mm (0.5 inch) 	3 m (10 ft)	—
QS18VN6RB			NPN
QS18VP6RB			PNP
Model <sup>1</sup>	Polarized Retroreflective Mode	Range	Output
QS18VN6LP	630 nm Visible red 	3.5 m (12 ft)	NPN
QS18VP6LP			PNP
Model <sup>1</sup>	Retroreflective Mode	Range	Output
QS18VN6LV	628 nm Visible red 	6.5 m (21 ft)	NPN
QS18VP6LV			PNP

- <sup>1</sup>
- To order the 9 m (30 ft) PVC cable model, add the suffix “W/30” to the cabled model number. For example, QS186E W/30.
  - To order the 4-pin M12/Euro-style integral quick disconnect model, add the suffix “Q8” to the model number. For example, QS186EQ8.
  - To order the 4-pin M8/Pico-style integral quick disconnect model, add the suffix “Q7” to the model number. For example, QS186EQ7.
  - To order the 150 mm (6 in) PVC cable model with a 4-pin M12/Euro-style quick disconnect, add the suffix “Q5” to the model number. For example, QS186EQ5.
  - To order the 150 mm (6 in) PVC cable model with a 4-pin M8/Pico-style quick disconnect, add the suffix “Q” to the model number. For example, QS186EQ.
  - Models with a quick disconnect require a mating cordset.



Model 1	Convergent Mode	Range	Output
QS18VN6CV15	630 nm Visible red 	16 mm (0.63 in)	NPN
QS18VP6CV15			PNP
QS18VN6CV45		43 mm (1.7 in)	NPN
QS18VP6CV45			PNP
Model 1	Diffuse Mode	Range	Output
QS18VN6D	940 nm Infrared 	450 mm (18 in)	NPN
QS18VP6D			PNP
QS18VN6DL		600 mm (24 in)	NPN
QS18VP6DL			PNP
QS18VN6DB (Diffuse, wide)		450 mm (18 in)	NPN
QS18VP6DB (Diffuse, wide)			PNP
Model 1	Divergent Mode	Range	Output
QS18VN6W	940 nm Infrared 	100 mm (4 in)	NPN
QS18VP6W			PNP
Model 1	Fixed Field Mode	Range	Output
QS18VN6FF50	660 nm Visible red 	50 mm (2 in)	NPN
QS18VP6FF50			PNP
QS18VN6FF100		100 mm (4 in)	NPN
QS18VP6FF100			PNP
Model 1	Plastic Fiber Optic Mode	Range	Output
QS18VN6FP	660 nm Visible Red 	Range varies by sensing mode and fiber optics used	NPN
QS18VP6FP			PNP
Model 1	Glass Fiber Optic Mode	Range	Output
QS18VN6F	940 nm Infrared 	Range varies by sensing mode and fiber optics used	NPN
QS18VP6F			PNP

## Wiring Diagrams

QS18 with NPN (Sinking) Outputs

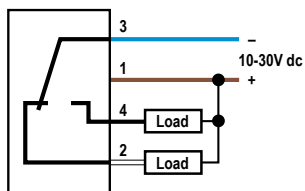

QS18 with PNP (Sourcing) Outputs

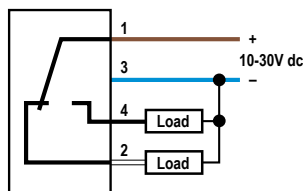

QS18 Emitters

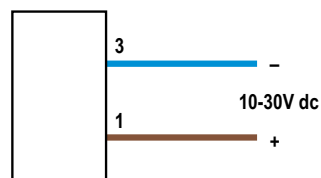

Key

- 1 = Brown
- 2 = White
- 3 = Blue
- 4 = Black

Quick disconnect (QD) wiring diagrams are functionally identical.

## Installing Fibers

### Cutting Unterminated Plastic Fibers QS18V..6FP

Unterminated plastic fibers are designed to be cut by the user to the length required for the application.

To facilitate cutting, a Banner model PFC-1 cutting device is supplied with the fiber. Cut the fiber as follows:

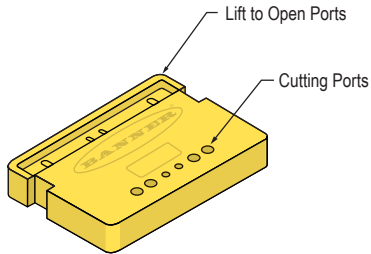

Figure 1. PFC-1 Cutting Device

Use small ports for fiber sizes:

- 0.25 mm (0.01 inches)
- 0.5 mm (0.02 inches)

Use large ports for fiber sizes:

- 0.75 mm (0.03 inches)
- 1.0 mm (0.04 inches)
- 1.5 mm (0.06 inches)

1. Locate the control end of the fiber (the unfinished end).
2. Determine the length of fiber required for the application. If using a bifurcated fiber, separate the two halves of the fiber at least 51 mm (2 inches) beyond the fiber cutting location.
3. Lift the top (blade) of the cutter to open the cutting ports.
4. Insert one of the control ends through one of the cutting ports on the cutter so that the excess fiber protrudes from the back of the cutter.
5. Double-check the fiber length, and close the cutter until the fiber is cut.
6. Using a different cutting port, cut the second control end to the required length.



**NOTE:** To ensure a clean cut each time, do not use a cutting port more than once.

7. Gently wipe the cut ends of the fiber with a clean, dry cloth to remove any contamination. Do not use solvents or abrasives on any exposed optical fiber.

### Installing Plastic Fibers QS18V..6FP

Follow these steps to install the plastic fibers.

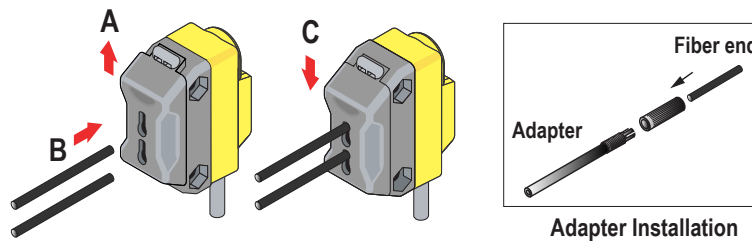

Figure 2. Installing Plastic Fibers

1. Slide the fiber gripper up to unlock it (A).
2. If using 0.25 mm or 0.5 mm core fibers, slide the plastic fiber adapters onto the fibers, flush with the fiber ends.
3. Carefully insert the prepared plastic fiber ends into the ports (B) as far as possible without applying extra force.
4. Slide the fiber gripper down to lock the fibers in place (C).

## Installing Glass Fibers QS18V..6F

Follow these steps to install the glass fibers.

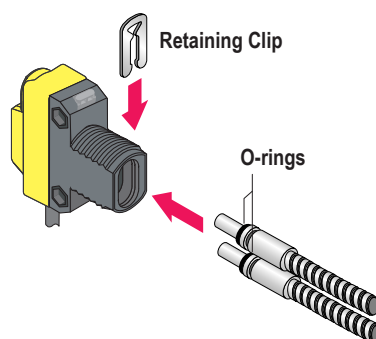

Figure 3. Installing Glass Fibers

1. Slide the supplied o-ring on the sensor end of the fibers, as shown.
2. Press the fiber ends firmly into the ports located on the front of the sensor.
3. Slide the supplied u-shaped retaining clip into the slot in the sensor's barrel until the clip snaps into place.

## Specifications

### Supply Voltage

10 V to 30 V dc (10% maximum ripple) at less than 25 mA, exclusive of load

Protected against reverse polarity and transient voltages

### Light Source

Glass Fiber Optic, Opposed and Diffuse mode models: Infrared, 940 nm  
 Plastic Fiber Optic, Retroreflective, Convergent and FF mode models: Visible red, 660 nm

### Adjustments

Glass Fiber Optic, Plastic Fiber Optic, Convergent, Diffuse, and Retroreflective mode models (only): Single-turn sensitivity (Gain) adjustment potentiometer

### Indicators

2 LED indicators on sensor top:

Green solid: Power on

Amber solid: Light sensed

Green flashing: Output overloaded

Amber flashing: Marginal excess gain (1 to 1.5 times excess gain)



NOTE: Prior to date code 0223, the output indicator was red.

### Required Overcurrent Protection



WARNING: Electrical connections must be made by qualified personnel in accordance with local and national electrical codes and regulations.

Overcurrent protection is required to be provided by end product application per the supplied table.

Overcurrent protection may be provided with external fusing or via Current Limiting, Class 2 Power Supply.

Supply wiring leads < 24 AWG shall not be spliced.

For additional product support, go to [www.bannerengineering.com](http://www.bannerengineering.com).

Supply Wiring (AWG)	Required Overcurrent Protection (Amps)
20	5.0
22	3.0
24	2.0
26	1.0
28	0.8
30	0.5

### Repeatability

Opposed Mode: 100 microseconds

FF Mode: 160 microseconds

DL Mode: 90 microseconds

All Other Modes: 150 microseconds

### Output Configuration

Solid-state complementary (SPDT): NPN or PNP (current sinking or sourcing), depending on model;

Rating: 100 mA maximum each output at 25 °C

DL Mode ON-state Saturation Voltage: less than 1.5 V at 10 mA; less than 3 V at 100 mA

All Other Modes: ON-state Saturation Voltage: less than 1 V at 10 mA; less than 1.5 V at 100 mA

Protected against false pulse on power-up and continuous overload or short circuit of outputs

### Output Response

Opposed Mode: 750 microseconds ON; 375 microseconds OFF

FF and DL Modes: 850 microseconds ON/OFF

All Other Modes: 600 microseconds ON/OFF

Note: 100 millisecond delay on power-up; outputs do not conduct during this time

### Construction

ABS housing

3 mm mounting hardware included

### Connections

2 m (6.5 ft) 4-wire PVC cable, 9 m (30 ft) 4-wire PVC cable, 4-pin Pico-style or Euro-style QD, 4-pin Pico-style or Euro-style 150 mm (6 in) QD, depending on model

### Environmental

IEC IP67; NEMA 6

### Operating Conditions

Temperature: -20 °C to 70 °C (-4 °F to 158 °F)

Relative Humidity: 95% at +50 °C maximum relative humidity (non-condensing)

### Certifications



## Dimensions and Features

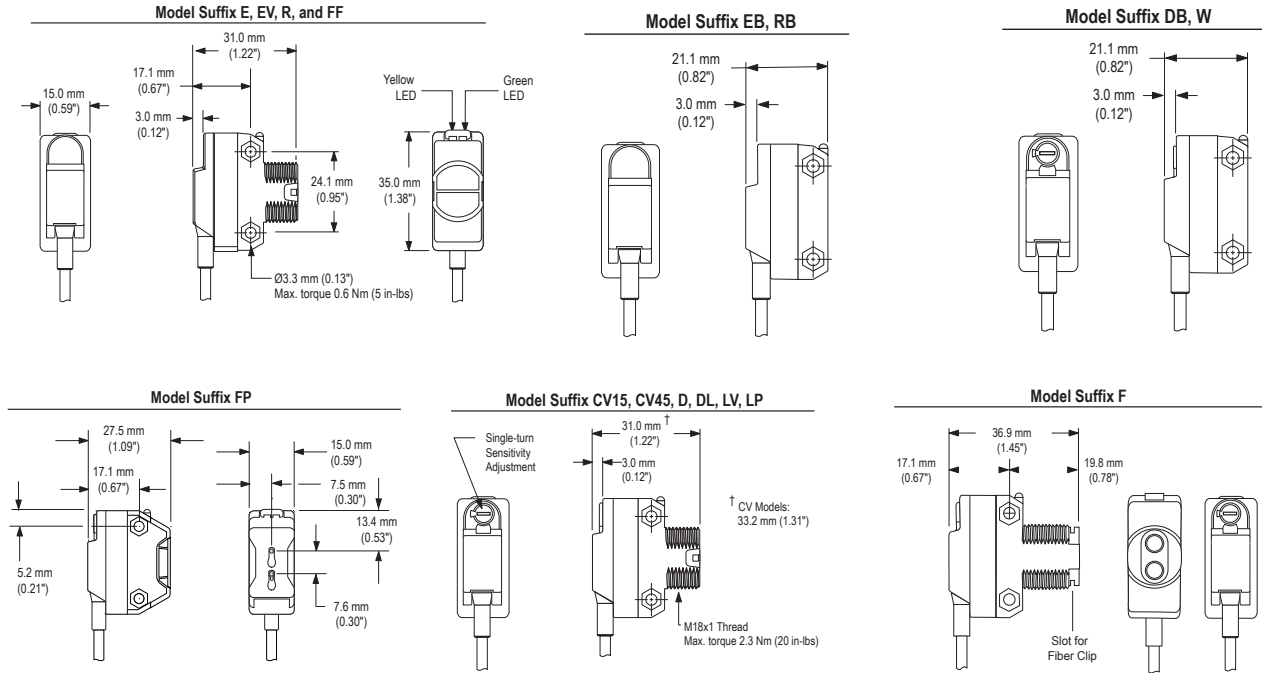

**Model Suffix Q**  
(e.g. QS186EQ)

**Model Suffix Q5**  
(e.g. QS186EQ5)

**Model Suffix Q7**  
(e.g. QS186EQ7)

**Model Suffix Q8**  
(e.g. QS186EQ8)

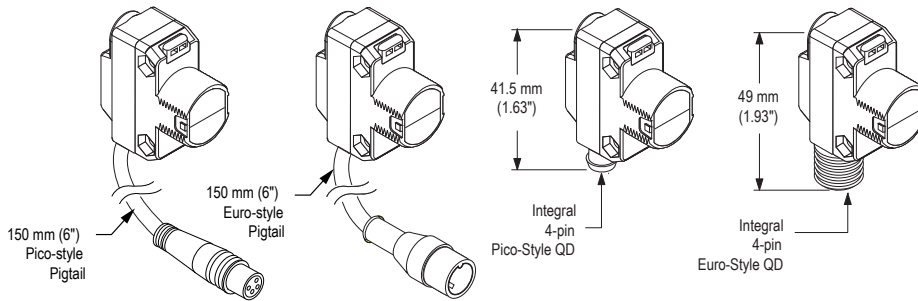

### M18 x 1 Jam Nut

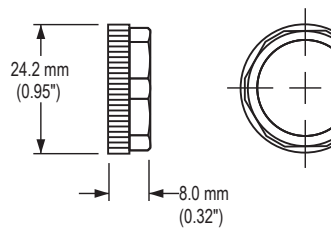

- M3 hardware packet contents:
- 2 - M3 x 0.5 x 20 mm stainless steel screw
  - 2 - M3 x 0.5 stainless steel hex nut
  - 2 - M3 stainless steel washer

### Packing List

- Sensor
- M18 x 1 jam nut
- M3 hardware packet
- Installation sheet, p/n 63687

Performance Curves

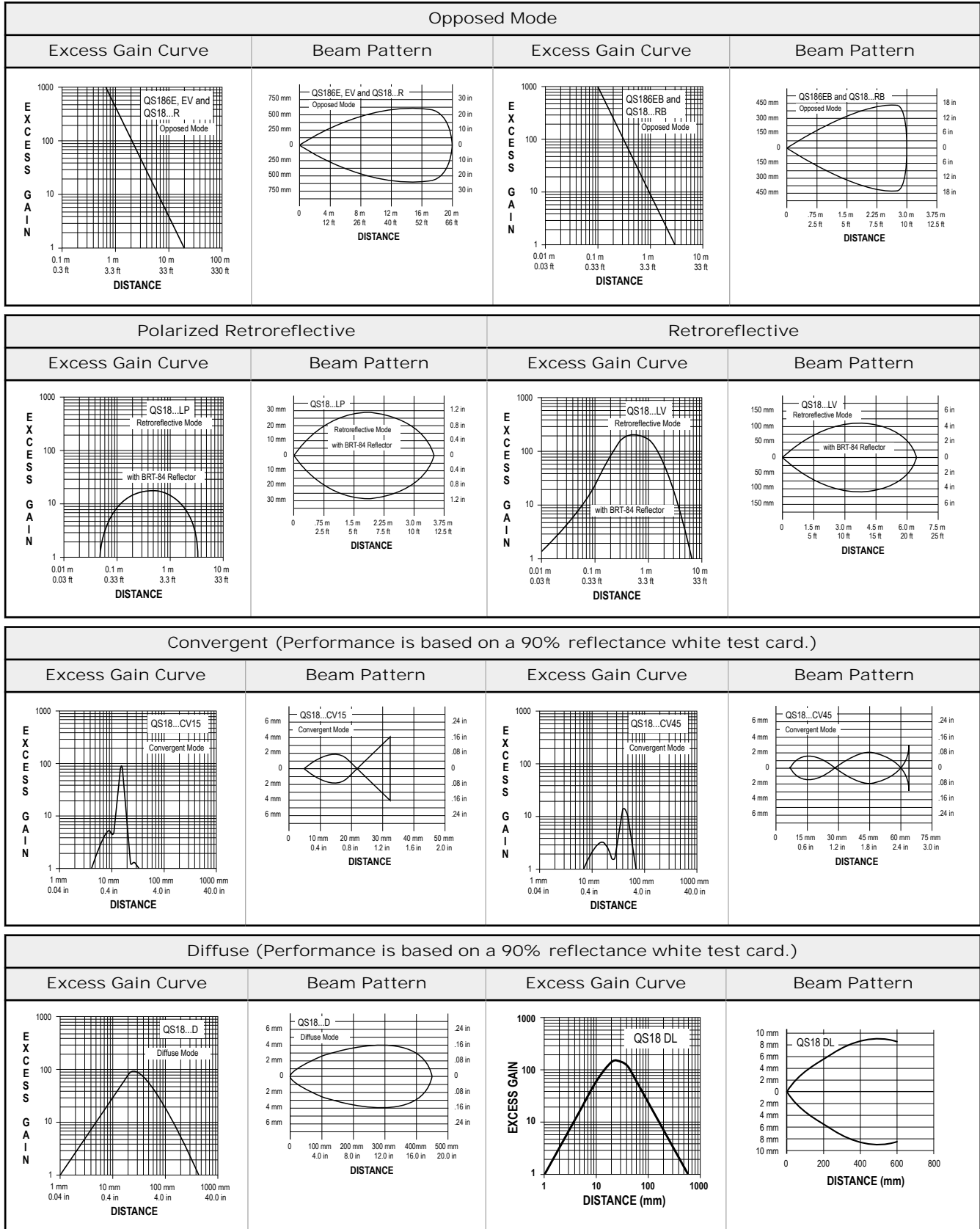

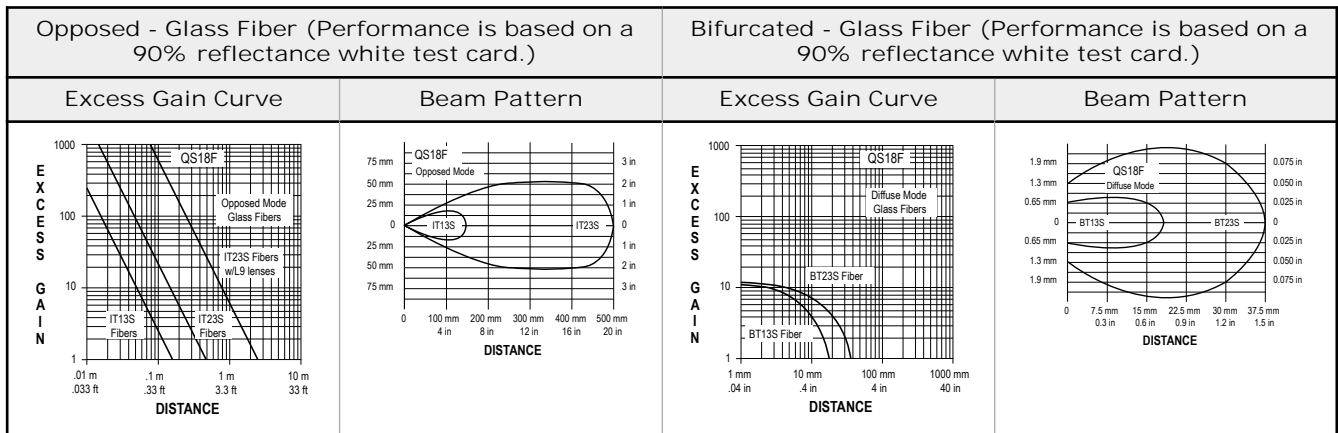
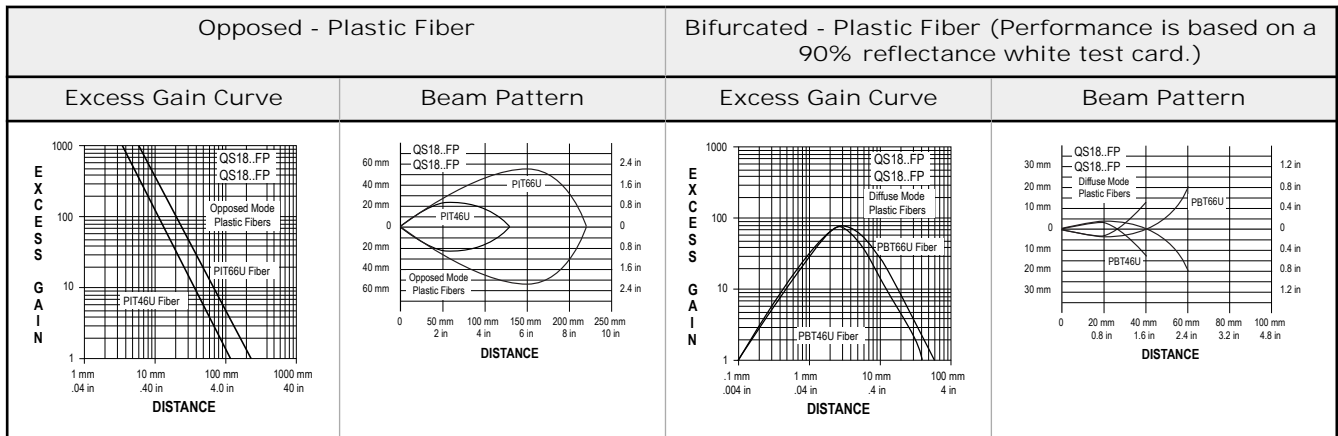
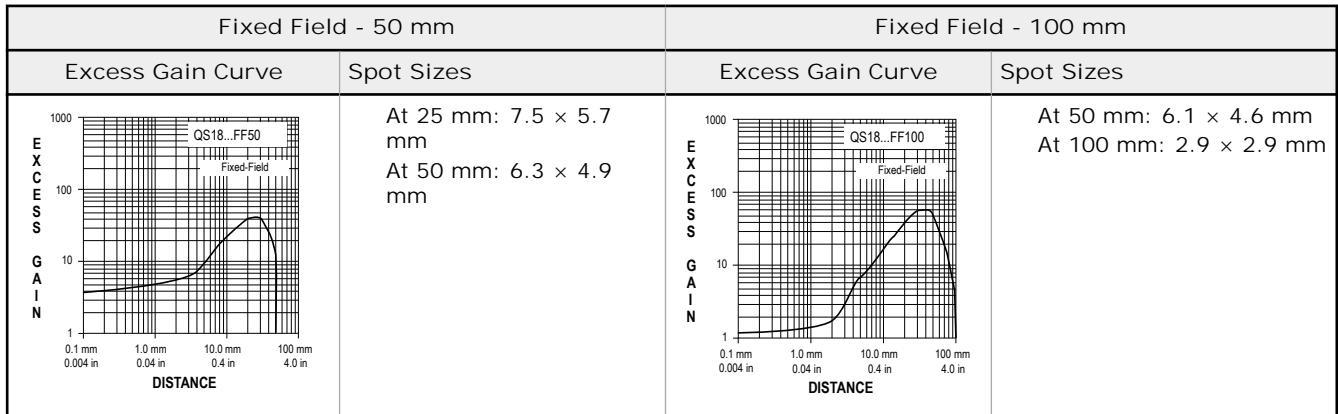
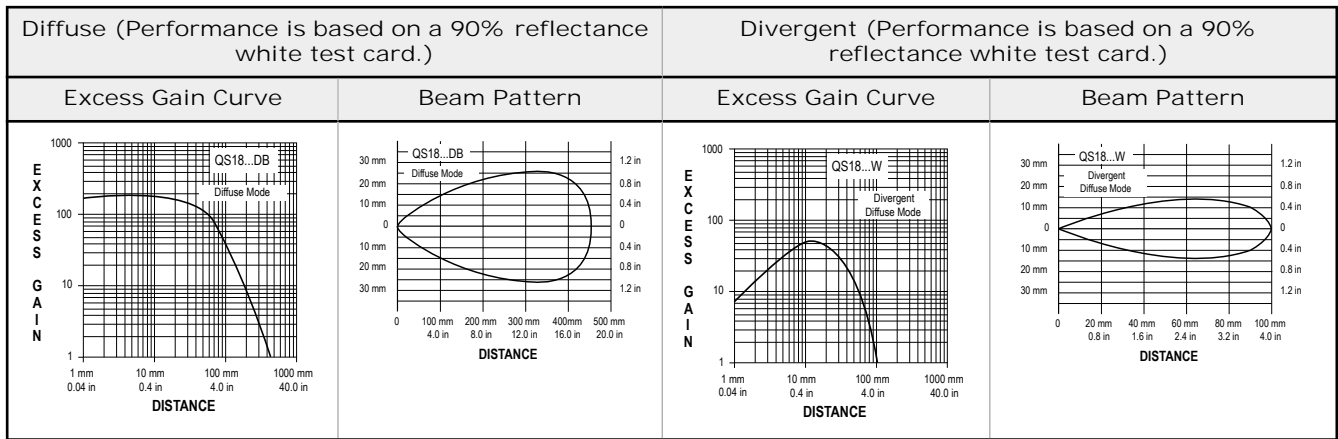

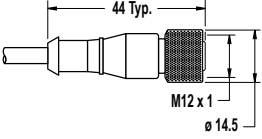
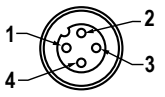
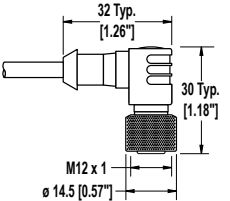

## Accessories

### Cordsets

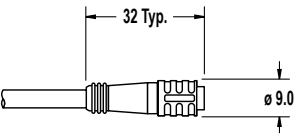
4-Pin Threaded M12/Euro-Style Cordsets				
Model	Length	Style	Dimensions	Pinout (Female)
MQDC-406	1.83 m (6 ft)	Straight		
MQDC-415	4.57 m (15 ft)			
MQDC-430	9.14 m (30 ft)			
MQDC-450	15.2 m (50 ft)			
MQDC-406RA	1.83 m (6 ft)	Right-Angle		1 = Brown 2 = White 3 = Blue 4 = Black
MQDC-415RA	4.57 m (15 ft)			
MQDC-430RA	9.14 m (30 ft)			
MQDC-450RA	15.2 m (50 ft)			

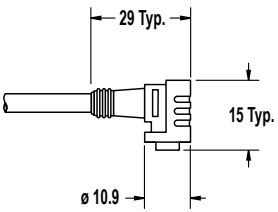
4-Pin Snap-on M8/Pico-Style Cordsets				
Model	Length	Style	Dimensions	Pinout (Female)
PKG4-2	2 m (6.56 ft)	Straight		
PKW4Z-2	2 m (6.56 ft)	Right-Angle		1 = Brown 2 = White 3 = Blue 4 = Black

### WORLD-BEAM QS18 Brackets

#### SMB18A

- Right-angle mounting bracket with a curved slot for versatile orientation
- 12-ga. stainless steel
- 18 mm sensor mounting hole
- Clearance for M4 (#8) hardware

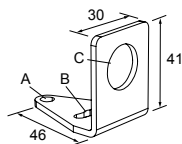

Hole center spacing: A to B = 24.2  
 Hole size: A = ø 4.6, B = 17.0 × 4.6, C = ø 18.5

#### SMB312S

- Stainless steel 2-axis, side-mount bracket

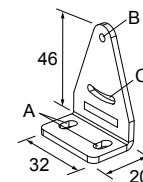

A = 4.3 × 7.5, B = diam. 3, C = 3 × 15.3

All measurements are in millimeters.



## Retroreflective Targets

Go to [www.bannerengineering.com](http://www.bannerengineering.com) or see the Accessories section of your current Banner Engineering Corp catalog for complete information.



NOTE: Polarized sensors require corner cube type retroreflective targets only.

## Plastic and Glass Fiber Optics

Go to [www.bannerengineering.com](http://www.bannerengineering.com) or see the Accessories section of your current Banner Engineering Corp catalog for a list of plastic and glass fiber optic cables.

## Banner Engineering Corp. Limited Warranty

---

Banner Engineering Corp. warrants its products to be free from defects in material and workmanship for one year following the date of shipment. Banner Engineering Corp. will repair or replace, free of charge, any product of its manufacture which, at the time it is returned to the factory, is found to have been defective during the warranty period. This warranty does not cover damage or liability for misuse, abuse, or the improper application or installation of the Banner product.

THIS LIMITED WARRANTY IS EXCLUSIVE AND IN LIEU OF ALL OTHER WARRANTIES WHETHER EXPRESS OR IMPLIED (INCLUDING, WITHOUT LIMITATION, ANY WARRANTY OF MERCHANTABILITY OR FITNESS FOR A PARTICULAR PURPOSE), AND WHETHER ARISING UNDER COURSE OF PERFORMANCE, COURSE OF DEALING OR TRADE USAGE.

This Warranty is exclusive and limited to repair or, at the discretion of Banner Engineering Corp., replacement. IN NO EVENT SHALL BANNER ENGINEERING CORP. BE LIABLE TO BUYER OR ANY OTHER PERSON OR ENTITY FOR ANY EXTRA COSTS, EXPENSES, LOSSES, LOSS OF PROFITS, OR ANY INCIDENTAL, CONSEQUENTIAL OR SPECIAL DAMAGES RESULTING FROM ANY PRODUCT DEFECT OR FROM THE USE OR INABILITY TO USE THE PRODUCT, WHETHER ARISING IN CONTRACT OR WARRANTY, STATUTE, TORT, STRICT LIABILITY, NEGLIGENCE, OR OTHERWISE.

Banner Engineering Corp. reserves the right to change, modify or improve the design of the product without assuming any obligations or liabilities relating to any product previously manufactured by Banner Engineering Corp. Any misuse, abuse, or improper application or installation of this product or use of the product for personal protection applications when the product is identified as not intended for such purposes will void the product warranty. Any modifications to this product without prior express approval by Banner Engineering Corp will void the product warranties. All specifications published in this document are subject to change; Banner reserves the right to modify product specifications or update documentation at any time. Specifications and product information in English supersede that which is provided in any other language. For the most recent version of any documentation, refer to: [www.bannerengineering.com](http://www.bannerengineering.com).