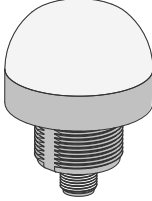
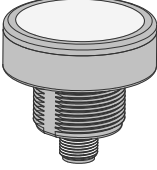
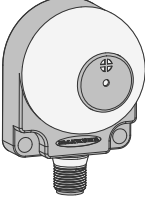

## Features

50 mm IO-Link controlled multicolor RGB indicator with audible models

 <p><b>Standard model</b></p>	 <p><b>Compact model</b></p>	 <p><b>Flush-mount model</b></p>	<ul style="list-style-type: none"> <li>Bright, uniform indicator light</li> <li>IO-Link control allows access to full color, flashing, and dimming controls as well as advanced animations</li> <li>Millions of color possibilities</li> <li>30 mm threaded polycarbonate base</li> <li>Translucent polycarbonate dome (standard models)</li> <li>Compact models are available for lower profile applications</li> <li>Rugged IP66, IP67, IP69K per DIN 40050-9, and UL Type 4X and UL Type 13 design</li> <li>Models with integrated audible alarm available</li> <li>Models constructed from FDA-grade materials available</li> </ul>
--	---	---	---

## Models

Model Key

Family	Material	Color and Input	Audible Alarm <sup>(1)</sup>	Connector <sup>(2)</sup>
K50L2 = Dome	Blank = Standard	RGBK = RGB Multicolor with IO-Link	Blank = No Audible	Q = Integral 4-pin M12 male quick-disconnect connector <sup>(3)</sup>
K50CL2 = Compact <sup>(3)</sup>	F = FDA-grade		A1 = Audible	QP = 150 mm (6 in) PVC-jacketed cable with a 4-pin M12 male quick-disconnect connector
K50FL2 = Flush-mount <sup>(3)</sup>			AL1 = Loud Audible ALS = Sealed Audible (IP67)	

## Wiring Diagram

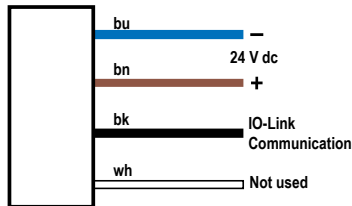

## IO-Link® Process Out Data

IO-Link is a point-to-point communication link between a master device and a sensor and/or light. It can be used to automatically parameterize sensors or lights and to transmit and/or receive process data. For the latest IO-Link protocol and specifications, please visit [www.io-link.com](http://www.io-link.com). For the latest IO-Link files, please refer to the Banner Engineering Corp website at: [www.bannerengineering.com](http://www.bannerengineering.com).

Process Data is transmitted cyclically to the IO-Link device from the IO-Link master. These parameters are written to the K50 acyclically and are used to perform the following functions:

- Indicator light on and off
- Audible on and off (audible models only)
- Full color control of indicator light (defined colors and ability to create custom colors)
- Full flashing control of indicator light (defined flashing rates and ability to create custom rates)
- Full dimming control of indicator light (defined intensities and ability to create custom intensities)
- Various animation control and configurability
  - Flashing: flash light at defined flash rate (50/50 duty cycle)
  - Two-Color Flashing: flash two colors at defined flash rate, alternating (50/50 duty cycle)
  - Strobe: strobe light at defined flash rate (80/20 duty cycle)
  - Half/Half: show half one color and half another color
  - Half/Half Rotate: animation that shows half one color and half another color while rotating clockwise or counter-clockwise

<sup>(1)</sup> Audible models are not available in FDA-grade material or compact models.

<sup>(2)</sup> Models with a quick-disconnect connector require a mating cordset.

<sup>(3)</sup> Compact models, flush-mount models, and models with an integral quick-disconnect connector are not available in FDA-grade materials.

- Chase: animation that shows a single spot in one color against a background of another color while rotating clockwise or counter-clockwise
- Demo Mode: cycles through defined colors and then through color spectrum

**NOTE:** Additional color shades can be made by adjusting intensity

IO-Link Process Data Out for the K50	
Name	Values
Color 1	Green, Red, Orange, Yellow, Lime Green, Spring Green, Cyan, Sky Blue, Blue, Violet, Magenta, Rose, White, 5 Custom Colors to define
Color 2	
Color Flash Rate (Hz)	0.5, 1.5, 3, 6, 9, 12, Custom Rate to define
Color 1 Intensity	High, Medium, Low, Custom Intensity to define
Color 2 Intensity	
Audible Mode	Off, On, Pulsed
Animation Mode	Steady, Flash, Two-Color Flash, Strobe, Half/Half, Half/Half Rotate, Chase, Demo Mode
Rotation Direction	Counter Clockwise, Clockwise

For more information see IO-Link Data Reference Guide: K50 Pro Indicator (p/n 200721).

## Specifications

### Supply Voltage and Current

- 24 V DC ± 25%
- 115 mA typical at 24 V DC
- 150 mA maximum at 18 V DC

### Supply Protection Circuitry

Protected against reverse polarity and transient voltages

### Input Response Time

30 milliseconds maximum while active

### Audible Alarm

- All models have a steady tone
- A1 Model:** 75 dB at 1 m (typical), 3 kHz ± 500 Hz
- AL1 Model:** 95 dB at 1 m (typical), 2.7 kHz ± 500 Hz
- ALS Model:** 94 dB at 1 m (typical), 2.9 kHz ± 250 Hz

### Connections

Integral 4-pin M12 male quick-disconnect connector, or 150 mm (6 in) PVC-jacketed cable with a 4-pin M12 male quick-disconnect connector, depending on model  
Models with a quick disconnect require a mating cordset

### Mounting

M30 by 1.5 threaded base, maximum torque 4.5 N·m (40 inch·lbf)  
Mounting nut included

### Construction

**Standard and Compact Model Base, Dome, and Nut:** Polycarbonate  
**FDA Model Base, Dome, and Nut:** FDA-grade polycarbonate

### Vibration and Mechanical Shock

Meets IEC 60068-2-6 requirements (Vibration: 10 Hz to 55 Hz, 1.0 mm amplitude, 5 minutes sweep, 30 minutes dwell)  
Meets IEC 60068-2-27 requirements (Shock: 30G 11 ms duration, half sine wave)

### Required Overcurrent Protection



**WARNING:** Electrical connections must be made by qualified personnel in accordance with local and national electrical codes and regulations.

Overcurrent protection is required to be provided by end product application per the supplied table.  
Overcurrent protection may be provided with external fusing or via Current Limiting, Class 2 Power Supply.  
Supply wiring leads < 24 AWG shall not be spliced.  
For additional product support, go to [www.bannerengineering.com](http://www.bannerengineering.com).

Supply Wiring (AWG)	Required Overcurrent Protection (A)	Supply Wiring (AWG)	Required Overcurrent Protection (A)
20	5.0	26	1.0
22	3.0	28	0.8
24	1.0	30	0.5

## Indicator Characteristics

Color	Dominant Wavelength (nm) or Color Temperature (CCT)	Color Coordinates <sup>(1)</sup>		Lumen Output (Typical at 25 °C) <sup>(2)</sup>
		x	y	
Green	530 nm	0.197	0.72	20.9
Red	625 nm	0.687	0.308	5.5
Yellow	–	0.493	0.471	14.6
Blue	470 nm	0.14	0.076	5.1
Orange	–	0.612	0.372	8.1
White	5700 K	0.328	0.337	20
Cyan	–	0.164	0.35	24
Magenta	–	0.382	0.179	7.3
Lime Green	–	0.387	0.561	25.9
Spring Green	–	0.18	0.529	22
Sky Blue	–	0.155	0.25	22.8
Violet	–	0.213	0.107	8.1

<sup>(1)</sup> Refer to CIE 1931 chromaticity diagram or color chart, to show equivalent color with indicated color coordinates.

<sup>(2)</sup> Values shown apply to dome models only. Compact models are 20% lower.

Color	Dominant Wavelength (nm) or Color Temperature (CCT)	Color Coordinates		Lumen Output (Typical at 25 °C)
		x	y	
Rose	–	0.507	0.231	6.2

### Operating Conditions

–40 °C to +50 °C (–40 °F to +122 °F)

90% at +50 °C maximum relative humidity (non-condensing)

Storage Temperature: –40 °C to +70 °C (–40 °F to +158 °F)

### Environmental Rating

Standard and Compact Models:

Non-Audible Models: IP66, IP67, IP69K per DIN 40050-9  
A1 and AL1 Models: IP50

ALS Models: IP67

All Models: Meets UL Type 4X and UL Type 13 when mounted in a UL Type 4X or Type 13 enclosure

All Cabled Models also meet IP69K per DIN 40050-9 if the cable and cable entrance are protected from high-pressure spray

FDA Models: IP66, IP67, IP69K per DIN 40050-9

### Certifications



## FCC Part 15 Class B

This equipment has been tested and found to comply with the limits for a Class B digital device, pursuant to part 15 of the FCC Rules. These limits are designed to provide reasonable protection against harmful interference in a residential installation. This equipment generates, uses and can radiate radio frequency energy and, if not installed and used in accordance with the instructions, may cause harmful interference to radio communications. However, there is no guarantee that interference will not occur in a particular installation. If this equipment does cause harmful interference to radio or television reception, which can be determined by turning the equipment off and on, the user is encouraged to try to correct the interference by one or more of the following measures:

- Reorient or relocate the receiving antenna.
- Increase the separation between the equipment and receiver.
- Connect the equipment into an outlet on a circuit different from that to which the receiver is connected.
- Consult the dealer or an experienced radio/TV technician for help.

## Industry Canada ICES-003(B)

This device complies with CAN ICES-3 (B)/NMB-3(B). Operation is subject to the following two conditions: 1) This device may not cause harmful interference; and 2) This device must accept any interference received, including interference that may cause undesired operation.

Cet appareil est conforme à la norme NMB-3(B). Le fonctionnement est soumis aux deux conditions suivantes : (1) ce dispositif ne peut pas occasionner d'interférences, et (2) il doit tolérer toute interférence, y compris celles susceptibles de provoquer un fonctionnement non souhaité du dispositif.

## Dimensions

All measurements are listed in millimeters [inches], unless noted otherwise.

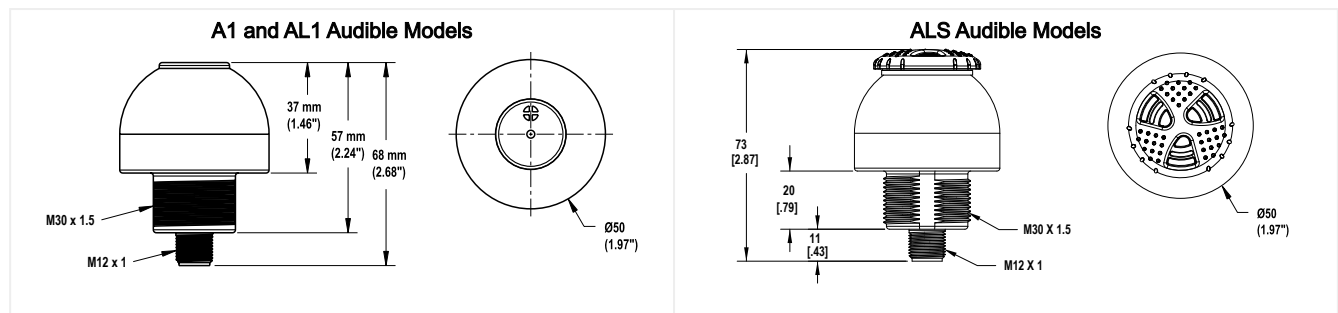

Continued on page 4

Continued from page 3

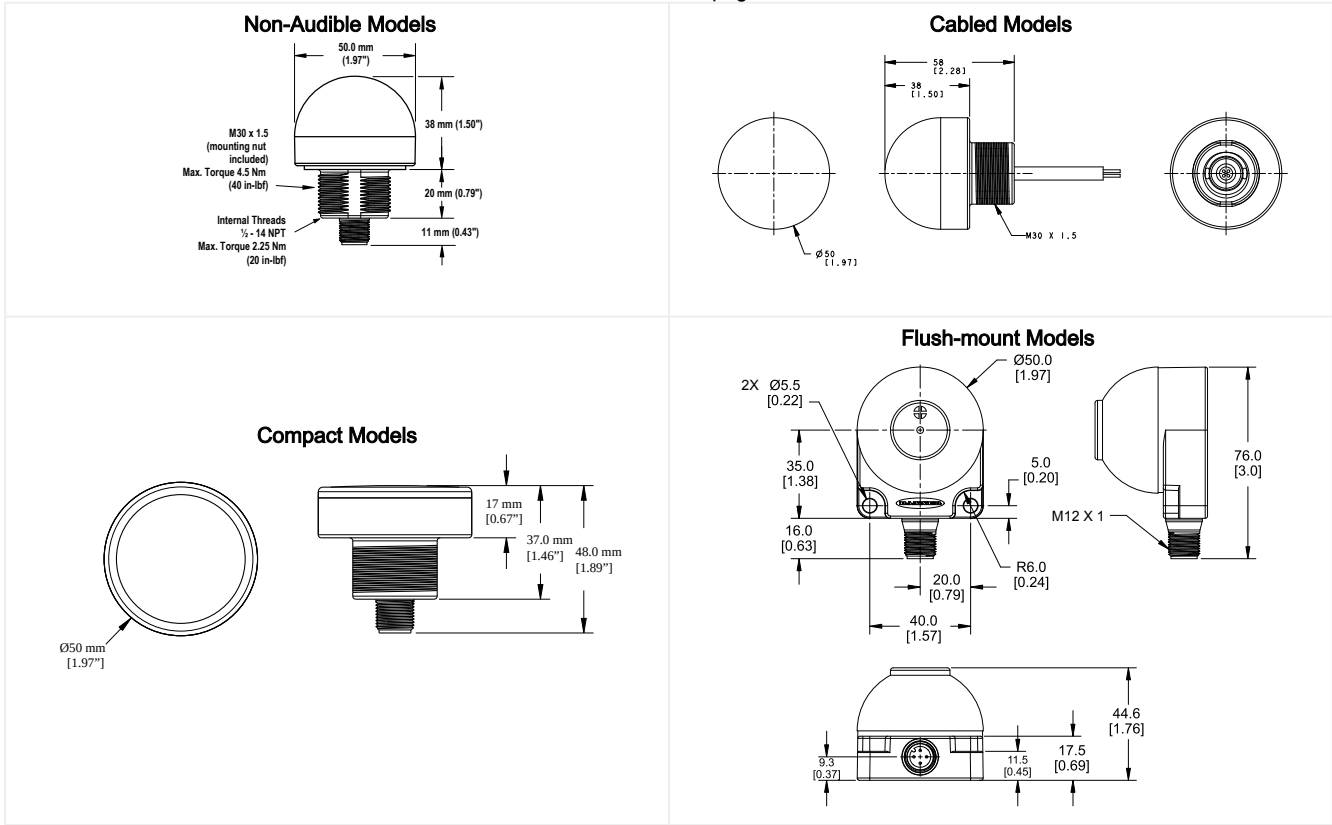

## Accessories

### Cordsets

4-Pin Threaded M12 Cordsets—Double Ended				
Model	Length	Style	Dimensions	Pinout
MQDEC-401SS	0.31 m (1 ft)	Male Straight/Female Straight		Female
MQDEC-403SS	0.91 m (2.99 ft)			Male
MQDEC-406SS	1.83 m (6 ft)			
MQDEC-412SS	3.66 m (12 ft)			
MQDEC-420SS	6.10 m (20 ft)			
MQDEC-430SS	9.14 m (30.2 ft)			
MQDEC-450SS	15.2 m (49.9 ft)			1 = Brown 2 = White 3 = Blue 4 = Black

## Brackets

### SMB30A

- Right-angle bracket with curved slot for versatile orientation
- Clearance for M6 (¼ in) hardware
- Mounting hole for 30 mm sensor
- 12-gauge stainless steel

**Hole center spacing:** A to B=40

**Hole size:** A=∅ 6.3, B= 27.1 × 6.3, C=∅ 30.5

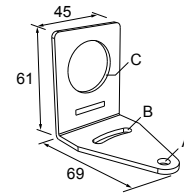

### SMB30FVK

- V-clamp, flat bracket and fasteners for mounting to pipe or extensions
- Clamp accommodates 28 mm dia. tubing or 1 in. square extrusions
- 30 mm hole for mounting sensors

**Hole size:** A= ∅ 31

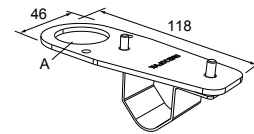

### SMB30RAVK

- V-clamp, right-angle bracket and fasteners for mounting sensors to pipe or extrusion
- Clamp accommodates 28 mm dia. tubing or 1 in. square extrusions
- 30 mm hole for mounting sensors

**Hole size:** A = ∅ 30.5

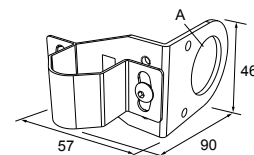

### SMBAMS30P

- Flat SMBAMS series bracket
- 30 mm hole for mounting sensors
- Articulation slots for 90°+ rotation
- 12-gauge 300 series stainless steel

**Hole center spacing:** A=26.0, A to B=13.0

**Hole size:** A=26.8 × 7.0, B=∅ 6.5, C=∅ 31.0

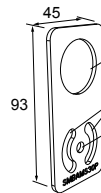

### SMBAMS30RA

- Right-angle SMBAMS series bracket
- 30 mm hole for mounting sensors
- Articulation slots for 90°+ rotation
- 12-gauge (2.6 mm) cold-rolled steel

**Hole center spacing:** A=26.0, A to B=13.0

**Hole size:** A=26.8 × 7.0, B=∅ 6.5, C=∅ 31.0

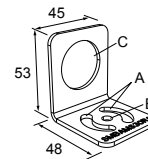

### SMB30MM

- 12-gauge stainless steel bracket with curved mounting slots for versatile orientation
- Clearance for M6 (¼ in) hardware
- Mounting hole for 30 mm sensor

**Hole center spacing:** A = 51, A to B = 25.4

**Hole size:** A = 42.6 × 7, B = ∅ 6.4, C = ∅ 30.1

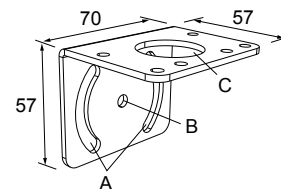

### SMB30SC

- Swivel bracket with 30 mm mounting hole for sensor
- Black reinforced thermoplastic polyester
- Stainless steel mounting and swivel locking hardware included

**Hole center spacing:** A=∅ 50.8

**Hole size:** A=∅ 7.0, B=∅ 30.0

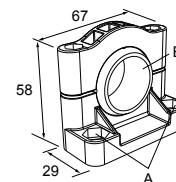

**SMB30FA**

- Swivel bracket with tilt and pan movement for precise adjustment
- Mounting hole for 30 mm sensor
- 12-gauge 304 stainless steel
- Easy sensor mounting to extrude rail T-slot
- Metric- and inch-size bolt available

**Bolt thread:** SMB30FA, A= 3/8 - 16 × 2 in; SMB30FAM10, A= M10 - 1.5 × 50  
**Hole size:** B= ø 30.1

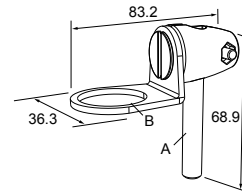

**LMBE12RA35**

- Direct mounting of stand-off pipe, with common bracket type
- Zinc-plated steel
- 1/2-14 NPSM nut
- Mounting distance from the wall to the center of the 1/2-14 NPSM nut is 35 mm

**Hole center spacing:** 20.0

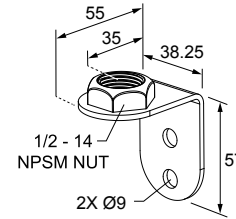

**LMBE12RA45**

- Direct mounting of stand-off pipe, with common bracket type
- Zinc-plated steel
- 1/2-14 NPSM nut
- Mounting distance from the wall to the center of the 1/2-14 NPSM nut is 45 mm

**Hole center spacing:** 35.0

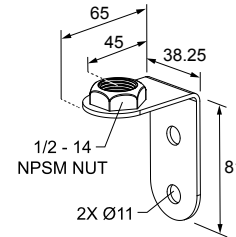

All measurements are listed in millimeters [inches], unless noted otherwise.

## Banner Engineering Corp Limited Warranty

Banner Engineering Corp. warrants its products to be free from defects in material and workmanship for one year following the date of shipment. Banner Engineering Corp. will repair or replace, free of charge, any product of its manufacture which, at the time it is returned to the factory, is found to have been defective during the warranty period. This warranty does not cover damage or liability for misuse, abuse, or the improper application or installation of the Banner product.

**THIS LIMITED WARRANTY IS EXCLUSIVE AND IN LIEU OF ALL OTHER WARRANTIES WHETHER EXPRESS OR IMPLIED (INCLUDING, WITHOUT LIMITATION, ANY WARRANTY OF MERCHANTABILITY OR FITNESS FOR A PARTICULAR PURPOSE), AND WHETHER ARISING UNDER COURSE OF PERFORMANCE, COURSE OF DEALING OR TRADE USAGE.**

This Warranty is exclusive and limited to repair or, at the discretion of Banner Engineering Corp., replacement. **IN NO EVENT SHALL BANNER ENGINEERING CORP. BE LIABLE TO BUYER OR ANY OTHER PERSON OR ENTITY FOR ANY EXTRA COSTS, EXPENSES, LOSSES, LOSS OF PROFITS, OR ANY INCIDENTAL, CONSEQUENTIAL OR SPECIAL DAMAGES RESULTING FROM ANY PRODUCT DEFECT OR FROM THE USE OR INABILITY TO USE THE PRODUCT, WHETHER ARISING IN CONTRACT OR WARRANTY, STATUTE, TORT, STRICT LIABILITY, NEGLIGENCE, OR OTHERWISE.**

Banner Engineering Corp. reserves the right to change, modify or improve the design of the product without assuming any obligations or liabilities relating to any product previously manufactured by Banner Engineering Corp. Any misuse, abuse, or improper application or installation of this product or use of the product for personal protection applications when the product is identified as not intended for such purposes will void the product warranty. Any modifications to this product without prior express approval by Banner Engineering Corp will void the product warranties. All specifications published in this document are subject to change; Banner reserves the right to modify product specifications or update documentation at any time. Specifications and product information in English supersede that which is provided in any other language. For the most recent version of any documentation, refer to: [www.bannerengineering.com](http://www.bannerengineering.com).

For patent information, see [www.bannerengineering.com/patents](http://www.bannerengineering.com/patents).

Document title: K50 Pro Indicator with IO-Link  
 Part number: 197816  
 Revision: G  
 Original Instructions  
 © Banner Engineering Corp. All rights reserved.

