

# WLS28-2 LED Strip Light - PWM Dimmable



## Datasheet



Banner's LED Strip Lights have sturdy aluminum housings, shatterproof windows, and impressive environmental ratings, making them an ideal general-purpose LED light for machine, enclosure, or other industrial lighting applications.

- Intensity can be controlled from 0 to 100% using Pulse Width Modulation (PWM) on an input control wire
- 40% brighter and 40% more efficient than previous model
- Low-profile, space-saving design
- Rugged, water-resistant IP69K option
- Available in eight lengths from 145 mm to 1130 mm
- Lensed models or choice of clear or diffuse window
- Daisy chain power to multiple lights to control intensity simultaneously
- Optional snap clips for easy installation and repositioning
- Automatic temperature protection built into the unit. Above 50 °C, the light dims to manage heat and protect product lifetime



For PWM dimming, use with the LC65 Dimmer Module. For more information, refer to the LC65 LED Dimmer Module datasheet, p/n [177086](#).

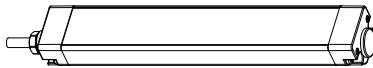

Stand-Alone Light—cable

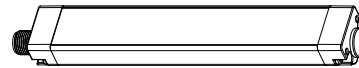

Stand-Alone Light or End Light in a Cascade—QD

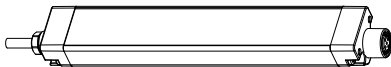

First Light in a Cascade—cable

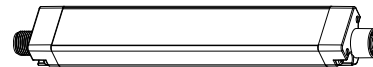

First or Middle of a Cascade—QD

WLS28-2 Work Light Strips are available as either stand-alone models, or as cascade models that can be "daisy-chained" together for a continuous length of lighting, with a minimum of wiring.

Stand-alone models have cable or male QD fitting at one end for power connection, no connections at opposite end. A stand-alone model may be used as the last in the cascade series.

Cascade models have cable or male QD fitting at one end for power connection, female QD fitting at opposite end for connection to other lights in the cascade. Cascade models with cable end can only be used as the first light in the cascade series. A double-ended accessory cordset must be used between each pair of lights in a cascade.

## Models

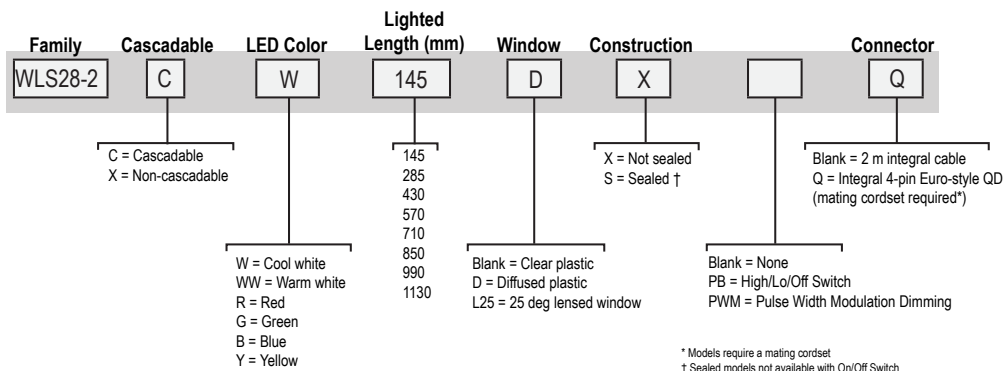

Table 1: IP50 Models

Stand-Alone <sup>1</sup>	Cascade <sup>1</sup>	Lighted Length	Power Connector
WLS28-2XW145XPWM	WLS28-2CW145XPWM	145 mm	2 m cable
WLS28-2XW285XPWM	WLS28-2CW285XPWM	285 mm	
WLS28-2XW430XPWM	WLS28-2CW430XPWM	430 mm	
WLS28-2XW570XPWM	WLS28-2CW570XPWM	570 mm	
WLS28-2XW710XPWM	WLS28-2CW710XPWM	710 mm	
WLS28-2XW850XPWM	WLS28-2CW850XPWM	850 mm	
WLS28-2XW990XPWM	WLS28-2CW990XPWM	990 mm	
WLS28-2XW1130XPWM	WLS28-2CW1130XPWM	1130 mm	

Table 2: IP67/IP69K Models

Stand-Alone <sup>1</sup>	Cascade <sup>1</sup>	Lighted Length	Power Connector
WLS28-2XW145SPWM	WLS28-2CW145SPWM	145 mm	2 m cable
WLS28-2XW285SPWM	WLS28-2CW285SPWM	285 mm	
WLS28-2XW430SPWM	WLS28-2CW430SPWM	430 mm	
WLS28-2XW570SPWM	WLS28-2CW570SPWM	570 mm	
WLS28-2XW710SPWM	WLS28-2CW710SPWM	710 mm	
WLS28-2XW850SPWM	WLS28-2CW850SPWM	850 mm	
WLS28-2XW990SPWM	WLS28-2CW990SPWM	990 mm	
WLS28-2XW1130SPWM	WLS28-2CW1130SPWM	1130 mm	

## Wiring Diagram

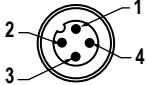
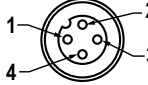
Male	Female	Pin	Wire Color	Connection
		1	brown	12 to 30 V dc
		3	blue	dc common
		4	black	Pulse width modulation (PWM) input. For maximum intensity, leave the black wire floating or connected to common.
		2	white	Not used

<sup>1</sup> Integral 2 m (6.5 ft) unterminated cable models are listed. To order the 4-pin M12/Euro-style integral quick disconnect model, add the suffix "Q" to the model number. For example, WLS28-2XW285XPWMQ.

## Specifications

### Supply Voltage and Current

12 V dc to 30 V dc  
Use only with suitable Class 2 power supply (UL) or a SELV power supply (CE).

### Supply Protection Circuitry

Protected against reverse polarity and transient voltages

### Light Characteristics

Color: Cool White  
Color Temperature (CCT): 6000–7100K  
Lumen output: 650 (± 5%) per foot, typical at 25 °C (77 °F)  
Luminous efficacy: 90 lumens/Watt typical at 24 V dc at 25 °C (77 °F)  
CRI: 85, typical

### LED Lifetime

Lumen Maintenance - L<sub>70</sub>  
When operating within specifications, output will decrease less than 30% after 50,000 hours.

### Construction

Clear anodized aluminum housing; painted zinc end caps; polycarbonate window on clear and diffuse plastic models; acrylic window on L25 models; zinc plated steel brackets

### Mounting

(2) swivel brackets SMBWLS28RA included and (4) screws

### Connections

Integral 4-pin M12 male quick disconnect (QD) (4-pin connecting cordset required); or 2 m (6.5 ft) integral cable



Note: Do not spray cable with high-pressure sprayer, or cable damage will result.

### Pulse Width Modulation (PWM)

Frequency: Up to 1000 Hz  
Voltage: 8 V dc to 30 V dc  
Current: 4 mA max. per foot

### Environmental Rating

IEC IP50 (non-sealed models) or IEC IP65, IEC IP67, IEC IP69K per DIN 40050 (sealed models)

### Vibration and Mechanical Shock

Vibration 10-55 Hz 1.0 mm p-p amplitude per IEC 60068-2-6  
Shock 15G 11 ms duration, half sine wave per IEC 60068-2-27

### Operating Temperature

-40 °C to +70 °C (-40 °F to +158 °F)  
Light output begins to decrease above 50 °C (122 °F) and will be approximately 65% of max intensity at 60 °C (140 °F) and 30% of max intensity at 70 °C (158 °F)

### Storage Temperature

-40 °C to +70 °C (-40 °F to +158 °F)

### Certifications



Sealed models only

### Application Note

When connecting cascable lights in series it is important not to exceed maximum current limitations:  
Maximum length of light at 12 V dc: 1.4 m (4.6 ft)  
Maximum length of light at 24 V dc: 3.0 m (9.8 ft)  
Maximum length of light at 30 V dc: 3.1 m (10.2 ft)

Table 3: Typical Current

Light Length	Typical Current			Max. Current A	Lumens <sup>2</sup> (Typical @25 °C) Cool White
	12 V dc	24 V dc	30 V dc		
145 mm	0.33 A	0.15 A	0.12 A	0.4	325
285 mm	0.66 A	0.30 A	0.24 A	0.8	650
430 mm	1.01 A	0.46 A	0.36 A	1.2	975
570 mm	1.36 A	0.61 A	0.48 A	1.6	1300
710 mm	1.75 A	0.77 A	0.60 A	2.0	1625
850 mm	2.13 A	0.92 A	0.73 A	2.4	1950
990 mm	2.59 A	1.08 A	0.85 A	2.8	2275
1130 mm	3.04 A	1.24 A	0.97 A	3.2	2600

<sup>2</sup> Lumen values lowered by 25% on diffused window models.

## Dimensions

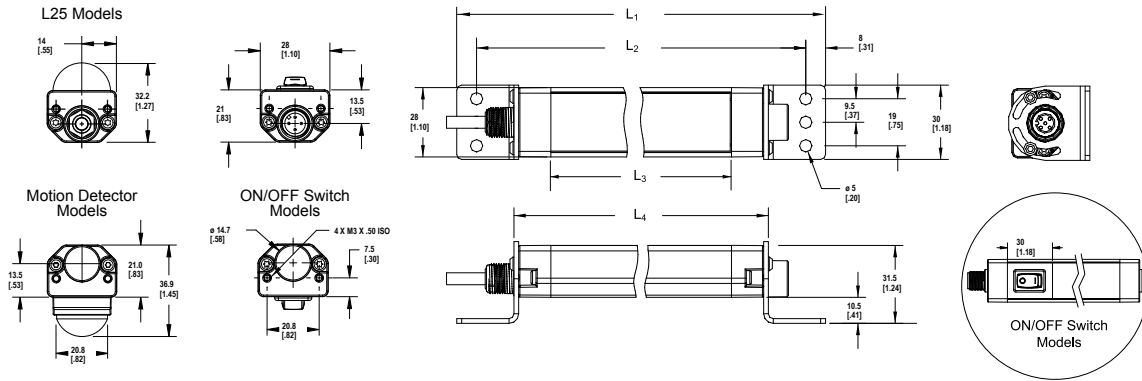

Dimensions are shown with the included SMBWLS28RA bracket.

IP50 Models	IP67/IP69K Models	L <sub>1</sub>	L <sub>2</sub>	L <sub>3</sub>	L <sub>4</sub>
WLS28-2..145XPWM	WLS28-2..145SPWM	221 mm (8.7 in)	205 mm (8.1 in)	145 mm (5.71 in)	175 mm (6.9 in)
WLS28-2..285XPWM	WLS28-2..285SPWM	362 mm (14.3 in)	346 mm (13.6 in)	286 mm (11.26 in)	316 mm (12.4 in)
WLS28-2..430XPWM	WLS28-2..430SPWM	503 mm (19.8 in)	487 mm (19.2 in)	427 mm (16.81 in)	457 mm (18.0 in)
WLS28-2..570XPWM	WLS28-2..570SPWM	644 mm (25.4 in)	628 mm (24.7 in)	568 mm (22.36 in)	598 mm (23.5 in)
WLS28-2..710XPWM	WLS28-2..710SPWM	785 mm (30.9 in)	769 mm (30.3 in)	709 mm (27.91 in)	739 mm (29.1 in)
WLS28-2..850XPWM	WLS28-2..850SPWM	926 mm (36.5 in)	910 mm (35.8 in)	850 mm (33.46 in)	880 mm (34.6 in)
WLS28-2..990XPWM	WLS28-2..990SPWM	1067 mm (42 in)	1051 mm (41.4 in)	991 mm (39.02 in)	1021 mm (40.2 in)
WLS28-2..1130XPWM	WLS28-2..1130SPWM	1208 mm (47.6 in)	1192 mm (46.9 in)	1132 mm (44.57 in)	1162 mm (45.7 in)

## Accessories

### Cordsets

Use single-ended cordsets between the power source and the QD connection of a stand-alone light or the first light in a cascade. Use double-ended cordsets between lights in a cascade.

4-Pin Threaded M12/Euro-Style Cordsets				
Model	Length	Style	Dimensions	Pinout (Female)
MQDC-406	1.83 m (6 ft)	Straight		<p>1 = Brown 2 = White 3 = Blue 4 = Black</p>
MQDC-415	4.57 m (15 ft)			
MQDC-430	9.14 m (30 ft)			
MQDC-450	15.2 m (50 ft)			
MQDC-406RA	1.83 m (6 ft)	Right-Angle		
MQDC-415RA	4.57 m (15 ft)			
MQDC-430RA	9.14 m (30 ft)			
MQDC-450RA	15.2 m (50 ft)			

4-Pin Threaded M12/Euro-Style Cordsets—Double Ended				
Model	Length	Style	Dimensions	Pinout
MQDEC-401SS	0.31 m (1 ft)	Male Straight/ Female Straight		Female
MQDEC-403SS	0.91 m (3 ft)			
MQDEC-406SS	1.83 m (6 ft)			Male
MQDEC-412SS	3.66 m (12 ft)			
MQDEC-420SS	6.10 m (20 ft)			<p>1 = Brown 2 = White 3 = Blue 4 = Black</p>
MQDEC-430SS	9.14 m (30 ft)			
MQDEC-450SS	15.2 m (50 ft)			

4-Pin Threaded M12/Euro-Style <b>Splitter</b> Cordsets—Flat Junction			
Model	Branches (Female)	Trunk (Male)	Pinout
CSB-M1240M1240	No branch	No trunk	<p>Female</p> <p>Male</p> <p>1 = Brown 2 = White 3 = Blue 4 = Black</p>
CSB-M1240M1241	2 x 0.30 m (1 ft)	No trunk	
CSB-M1241M1241		0.30 m (1 ft)	
CSB-M1248M1241		2.50 m (8 ft)	
CSB-M12415M1241		4.57 m (15 ft)	
CSB-M12425M1241		7.60 m (25 ft)	
CSB-UNT425M1241		7.60 m (25 ft) Unterminated	

Brackets

SMBWLS28RA

The bracket kit is available as a replacement for the one that comes with the Work Light Strip. The kit contains two end brackets and four screws.

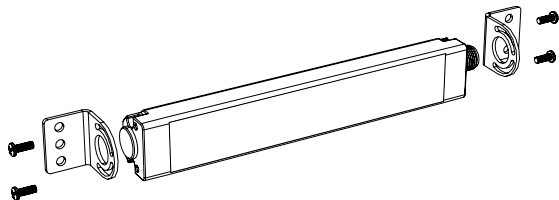

SMBWLS28SM

This kit allows the light to be mounted at a right angle to the mounting surface. The kit contains two end brackets and four screws.

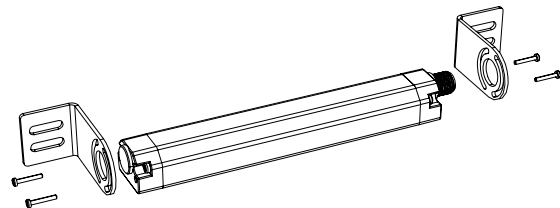

**SMBWLS28SP**

- Stainless steel snap bracket kit
- Includes two brackets

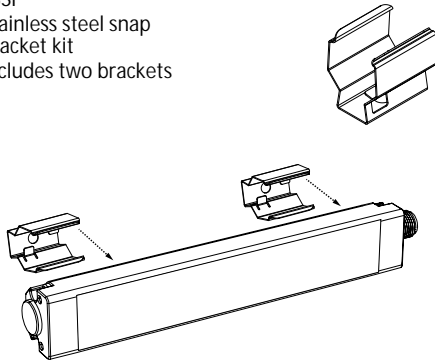
**SMH1316**

This kit allows the light to be mounted to a 1/2-inch Unistrut channel. The kit includes:

- #10-32 spring nuts (qty 2)
- #10-32 socket head cap screws (qty 2)
- #10 lock washers (qty 2)

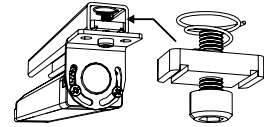
**SMBWLSMAG**

Magnetic mounting bracket for easy attachment to steel surfaces

**SMBWLSMAGR**

Protective cover also available to prevent scratches to painted surfaces

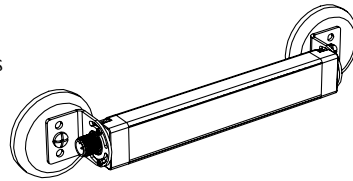

## Banner Engineering Corp. Limited Warranty

Banner Engineering Corp. warrants its products to be free from defects in material and workmanship for one year following the date of shipment. Banner Engineering Corp. will repair or replace, free of charge, any product of its manufacture which, at the time it is returned to the factory, is found to have been defective during the warranty period. This warranty does not cover damage or liability for misuse, abuse, or the improper application or installation of the Banner product.

THIS LIMITED WARRANTY IS EXCLUSIVE AND IN LIEU OF ALL OTHER WARRANTIES WHETHER EXPRESS OR IMPLIED (INCLUDING, WITHOUT LIMITATION, ANY WARRANTY OF MERCHANTABILITY OR FITNESS FOR A PARTICULAR PURPOSE), AND WHETHER ARISING UNDER COURSE OF PERFORMANCE, COURSE OF DEALING OR TRADE USAGE.

This Warranty is exclusive and limited to repair or, at the discretion of Banner Engineering Corp., replacement. IN NO EVENT SHALL BANNER ENGINEERING CORP. BE LIABLE TO BUYER OR ANY OTHER PERSON OR ENTITY FOR ANY EXTRA COSTS, EXPENSES, LOSSES, LOSS OF PROFITS, OR ANY INCIDENTAL, CONSEQUENTIAL OR SPECIAL DAMAGES RESULTING FROM ANY PRODUCT DEFECT OR FROM THE USE OR INABILITY TO USE THE PRODUCT, WHETHER ARISING IN CONTRACT OR WARRANTY, STATUTE, TORT, STRICT LIABILITY, NEGLIGENCE, OR OTHERWISE.

Banner Engineering Corp. reserves the right to change, modify or improve the design of the product without assuming any obligations or liabilities relating to any product previously manufactured by Banner Engineering Corp. Any misuse, abuse, or improper application or installation of this product or use of the product for personal protection applications when the product is identified as not intended for such purposes will void the product warranty. Any modifications to this product without prior express approval by Banner Engineering Corp will void the product warranties. All specifications published in this document are subject to change; Banner reserves the right to modify product specifications or update documentation at any time. Specifications and product information in English supersede that which is provided in any other language. For the most recent version of any documentation, refer to:

[www.bannerengineering.com](http://www.bannerengineering.com).