

# SureCross DX85 Modbus RTU Remote I/O Device



Configurable Modbus slave remote I/O device with four sourcing discrete inputs and eight sourcing discrete outputs

## Features



The SureCross™ wireless system is a radio frequency network with integrated I/O that can operate in most environments while eliminating the need for wiring runs. Systems are built around a Gateway, which acts as the wireless network master device, and one or more Nodes. A remote I/O device with a Modbus interface is used to expand the I/O of the Gateway device or the Modbus host.

- Wireless industrial I/O device with four sourcing discrete inputs and eight sourcing discrete outputs
- 10 to 30V dc power input
- Selectable Modbus slave address
- Modbus RTU protocol using RS-485
- The DX85...C models are certified for use in Class I, Division 2, Group A, B, C, D; and Zone 2 (Group IIC) Hazardous Locations when properly installed in accordance with the National Electrical Code, the Canadian Electrical Code, LCIE/ATEX, or applicable local codes/regulations (see Specifications)

For additional information, the most recent version of all documentation, and a complete list of accessories, refer to Banner Engineering's website, [www.bannerengineering.com/surecross](http://www.bannerengineering.com/surecross).

## Models

Model	Environmental Rating	I/O
DX85M4P8	IP67, NEMA 6	<b>Inputs:</b> Four sourcing discrete <b>Outputs:</b> Eight sourcing discrete
DX85M4P8C	IP20, NEMA 1 Class I, Division 2, Group A, B, C, D Hazardous Locations (see <i>Specifications</i> )	



### WARNING: Not To Be Used for Personnel Protection

Never use this product as a sensing device for personnel protection. Doing so could lead to serious injury or death. This product does NOT include the self-checking redundant circuitry necessary to allow its use in personnel safety applications. A sensor failure or malfunction can cause either an energized or de-energized sensor output condition.



## The SureCross DX80 Wireless Network

The SureCross DX80 wireless I/O network provides reliable monitoring without the burden of wiring or conduit installation. The SureCross wireless network can operate independently or in conjunction with a host system, PLC, and/or PC software.

Each wireless network system consists of one Gateway and one or more Nodes. Devices ship with factory defined inputs and outputs that may be all discrete, all analog, or a mix of discrete and analog I/O.

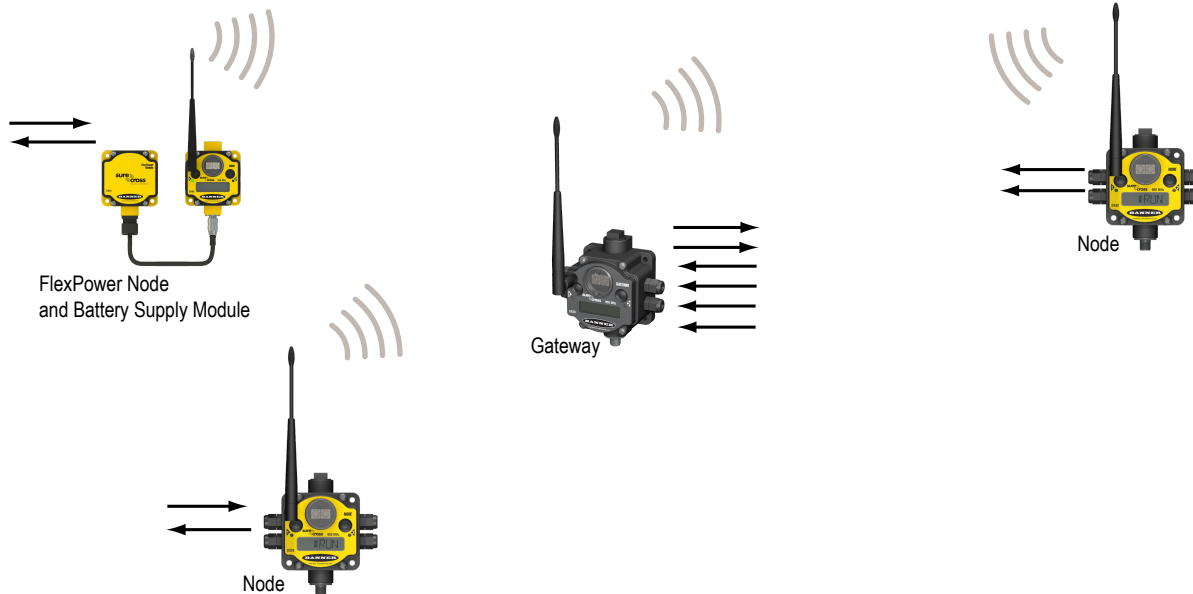

The SureCross DX80 network is a deterministic system—the network identifies when the radio signal is lost and drives relevant outputs to user-defined conditions. Once the radio signal is reacquired, the network returns to normal operation.

### SureCross DX80 Gateways and Nodes

A **Gateway** acts as the master device within each radio network, initiates communication and reporting with the Nodes, and controls the timing for the entire network.

The Gateway also holds the configuration for the network. Every wireless network must have one Gateway that schedules communication traffic and controls the I/O configuration for the network. A radio network contains only one Gateway, but can contain many Nodes. Similar to how a gateway device on a wired network acts as a “portal” between networks, the SureCross Gateway acts as the portal between the wireless network and the central control process.

A **Node** is a wireless network end-point device used to provide sensing capability in a remote area or factory. The Node collects data from sensors and communicates the data back to the Gateway. Nodes are available in a wide variety of power or input/output options. Each Node device can be connected to sensors or output devices and reports I/O status to the Gateway.

### DX85 Modbus RTU I/O Slaves

Use the DX85 Modbus RTU I/O devices to expand the I/O of a Modbus master device. DX85s are hardwired to Modbus master devices using RS-485 and use Modbus RTU to exchange data. DX85s are available with discrete, analog, or a mix of discrete and analog I/O.

### Additional Information

For additional information, including installation and setup, weatherproofing, device menu maps, troubleshooting, and a list of accessories, refer to one of the following product manuals

- SureCross Quick Start Guide: Banner part number [128185](#)
- SureCross Wireless I/O Network Manual: [132607](#)
- Web Configurator Manual (used with "Pro" and DX83 models): [134421](#)

## Wiring Diagrams

### 5-pin Euro-Style Hookup

Wiring the 5-pin Euro-style connector depends on the model and power requirements of the device. Connecting dc power to the communication pins will cause permanent damage.



Wire No.	Wire Color	Description
1	Brown	10 to 30V dc
2	White	RS485 / D1 / B / +
3	Blue	dc common (GND)
4	Black	RS485 / D0 / A / -
5	Gray	Comms Gnd

### Terminal Block (IP67 Housing)

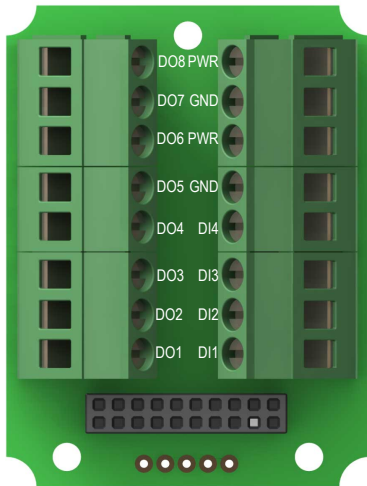

DIx. Discrete IN x.

DOx. Discrete OUT x.

GND. Ground/dc common connection.

PWR. Power, 10 to 30V dc power connection.

### DX80...C Wiring

Wiring power to the DX80...C models varies depending on the power requirements of the model.

Terminal Label	Gateway, DX85 *	10 to 30V dc Powered Nodes	Battery Powered Nodes **
V+	10 to 30V dc	10 to 30V dc	
Tx/+	RS485 / D1 / B / +		
V-	dc common (GND)	dc common (GND)	dc common (GND)
Rx/-	RS485 / D0 / A / -		
B+			3.6 to 5.5V dc

\* Connecting dc power to the communication pins will cause permanent damage.

\*\* For FlexPower devices, do not apply more than 5.5V to the gray wire.

## Terminal Block (IP20 Housing)

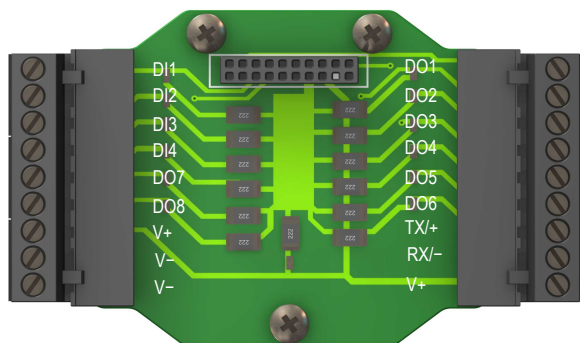

- DIx. Discrete IN x.
- DOx. Discrete OUT x.
- RX/-. Serial comms line
- TX/+. Serial comms line
- V+. Power, 10 to 30V dc power connection.
- V-. Ground/dc common connection.

## Wiring Diagrams for Discrete Inputs

Connecting dc power to the communication pins will cause permanent damage. For the DX8x...C models, PWR in the wiring diagram refers to V+ on the wiring board and GND in the wiring diagram refers to V- on the wiring board.

### Discrete Input Wiring (PNP)

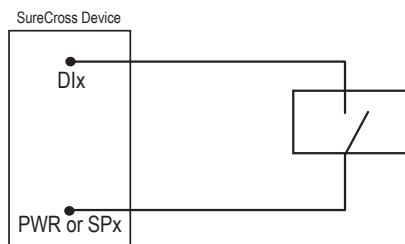

### Discrete Input Wiring (NPN)

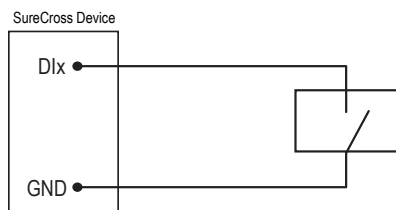

## Wiring Diagrams for Discrete Outputs

Connecting dc power to the communication pins will cause permanent damage. For the DX8x...C models, PWR in the wiring diagram refers to V+ on the wiring board and GND in the wiring diagram refers to V- on the wiring board.

### Discrete Output Wiring (PNP)

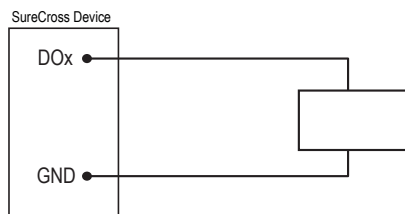

## Modbus Register Table

I/O Point	Modbus Holding Register		I/O Type	Units	I/O Range		Holding Register Representation		Terminal Block Labels
	Gateway or DX85	Any Node			Min. Value	Max. Value	Min. (Dec.)	Max. (Dec.)	
1	1	1 + (Node# × 16)	Discrete IN 1	-	0	1	0	1	DI1
2	2	2 + (Node# × 16)	Discrete IN 2	-	0	1	0	1	DI2
3	3	3 + (Node# × 16)	Discrete IN 3	-	0	1	0	1	DI3
4	4	4 + (Node# × 16)	Discrete IN 4	-	0	1	0	1	DI4

I/O Point	Modbus Holding Register		I/O Type	Units	I/O Range		Holding Register Representation		Terminal Block Labels
	Gateway or DX85	Any Node			Min. Value	Max. Value	Min. (Dec.)	Max. (Dec.)	
5	5	5 + (Node# × 16)							
6	6	6 + (Node# × 16)							
7	7	7 + (Node# × 16)	Reserved						
8	8	8 + (Node# × 16)	Device Message						
9	9	9 + (Node# × 16)	Discrete OUT 1–8	-	0	**	0	255	DO1
10	10	10 + (Node# × 16)							
11	11	11 + (Node# × 16)							
12	12	12 + (Node# × 16)							
13	13	13 + (Node# × 16)							
14	14	14 + (Node# × 16)							
15	15	15 + (Node# × 16)	Control Message						
16	16	16 + (Node# × 16)	Reserved						

The lower eight bits of the 16-bit unsigned register represent each of the eight digital outputs. Therefore, if all outputs are OFF (0) the register contains 0x0000; if all outputs are ON (1) the register contains 0x00FF (255).

When your wireless network does not include a host system, the four input/eight output Node must be mapped to the eight input/four output Gateway.

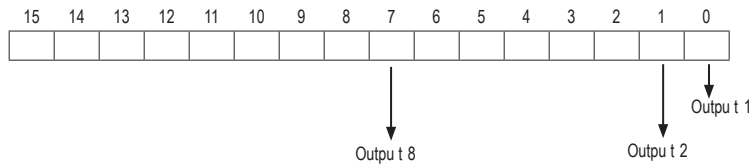

## Device Configuration

### Setting the Slave ID on a DX85 Remote I/O Device

On a DX85 Modbus RTU Remote I/O device, use the rotary dials to set the device's Slave ID.

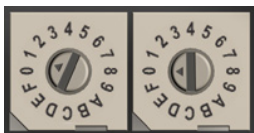

In Rotary Dial Decimal Mode, the left dial acts as the left digit and the right dial acts as the right digit, allowing the Slave ID to be set from 01 through 99.

In Rotary Dial Hex Mode, the left dial acts as the left digit and the right dial acts as the right digit, allowing the Slave ID to be set from 01 through F7 for a total of 247 slaves.

The 12 I/O DX85 models use Rotary Dial Decimal Mode and do not have a DIP switch selection for this option.

To configure the DX85 using the UCT, the DX85's Slave ID must be set to 01.

## DIP Switch Changes

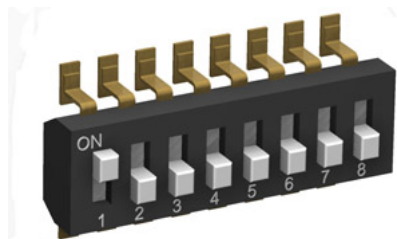

Before making any changes to the DIP switch positions, disconnect the power. For devices with batteries integrated into the housing, remove the battery for at least one minute.

DIP switch changes will not be recognized if power isn't cycled to the device.

## Accessing the DIP Switches

To access the DIP switches, follow these steps:

1. Unscrew the four screws that mount the cover to the bottom housing.
2. Remove the cover from the housing without damaging the ribbon cable or the pins the cable plugs into.
3. Gently unplug the ribbon cable from the board mounted into the bottom housing. For integrated battery models (no ribbon cable) and Class I, Division 2 certified devices (ribbon cable is glued down), skip this step.
4. Remove the black cover plate from the bottom of the device's cover.

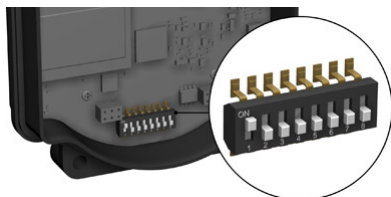

The DIP switches are located behind the rotary dials. After making the necessary changes to the DIP switches, place the black cover plate back into position and gently push into place. Plug the ribbon cable in after verifying that the blocked hole lines up with the missing pin. Mount the cover back onto the housing.

## DIP Switch Settings for a DX85





Use the DIP switches 1 through 4 on the board to set the baud rate and parity and DIP switch 5 to set the rotary dial mode.

	DIP Switches				
	1	2	3	4	5
Baud Rate: 19200	OFF*	OFF*			
Baud Rate: 38400	OFF	ON			
Baud Rate: 9600	ON	OFF			
Baud Rate: 19200	ON	ON			
Parity: None			OFF*	OFF*	
Parity: Even			OFF	ON	
Parity: Odd			ON	OFF	
Parity: None			ON	ON	
Rotary Dial Decimal Mode					OFF*
Rotary Dial Hex Mode					ON

\* Default configuration

## Verify Communications on the DX85 Modbus RTU Remote I/O

After powering up, verify the DX85 is communicating properly. LED 1 should be on and green.

Status	LED 1	LED 2
Power ON	 Green ON	-
Device error, contact factory	 Red flashing	 Red flashing
Modbus communication active	-	 Yellow flashing
Modbus communication error	-	 Red flashing

The Modbus communication LEDs refer to the communication between the DX85 and what it is connected to (host system, Gateway, Data Radio, etc).

## Specifications

### General

#### Power\*

Requirements: +10 to 30V dc (For European applications: +10 to 24V dc,  $\pm 10\%$ ). (See UL section below for any applicable UL specifications)  
Consumption: Less than 1.4 W (60 mA) at 24V dc

#### Housing

Polycarbonate  
Weight: 0.26 kg (0.57 lbs)  
Mounting: #10 or M5 (M5 hardware included)  
Max. Tightening Torque: 0.56 N·m (5 in·lbf)

#### Interface

Indicators: Two bi-color LEDs

#### Wiring Access

Four PG-7, One 1/2-inch NPT, One 5-pin Euro-style male connector

\* For European applications, power the DX80 from a Limited Power Source as defined in EN 60950-1.

### Inputs and Outputs

#### Discrete Inputs

Rating: 3 mA max current at 30V dc  
ON Condition: Greater than 8V  
OFF Condition: Less than 5V

#### Discrete Outputs

ON Condition: Supply minus 2V  
OFF Condition: Less than 2V

#### Discrete Output Rating (PNP)

100 mA max current at 30V dc  
ON-State Saturation: Less than 3V at 100 mA  
OFF-state Leakage: Less than 10  $\mu$ A

### Communication

#### Hardware (RS-485)

Interface: 2-wire half-duplex RS-485  
Baud Rates: 9.6k, 19.2k (default), or 38.4k  
Data Format: 8 data bits, no parity, 1 stop bit

### Environmental

#### Environmental

#### Shock and Vibration

IEC 68-2-6 and IEC 68-2-7

Rating for DX85 models: IEC IP67; NEMA 6; (See UL section below for any applicable UL specifications)

Rating for DX85...C models: IEC IP20; NEMA 1 (In a suitable enclosure: Class I, Division 2, Group A, B, C, D; T4 -40 to 80° C)

Operating Temperature: -40 to +85° C (Electronics);  
-20 to +80° C (LCD)

Operating Humidity: 95% max. relative (non-condensing)

Radiated Immunity: 10 V/m, 80-2700 MHz  
(EN61000-6-2)

Shock: 30g, 11 millisecond half sine wave, 18 shocks

Vibration: 0.5 mm p-p, 10 to 60 Hz

Refer to the SureCross™ DX80 Wireless I/O Network product manual, Banner p/n 132607, for installation and waterproofing instructions. Operating the devices at the maximum operating conditions for extended periods can shorten the life of the device.

## Certifications

### DX8x...C (External Wiring Terminal Models)

CSA: Class I, Division 2, Groups A, B, C, D (Ex/A Ex nA II T4); Certificate: 1921239 c



LCIE/ATEX: Zone 2 (II 3G / Ex nA IIC); Certificate: LCIE 10 ATEX 1012 X



### UL Listing

Maximum ambient temperature: 70°C

Mounting instructions: See document 132607

Power rating: 10 to 30V dc, UL Class 2

Enclosure environmental rating: UL Type 1



## Included with Device (DX85 and DX85...C Models)

The following items ship with the DX85 models.

Included with Device	Model	Qty	Item
DX80 Access Hardware Kit *	BWA-HW-002	4	Plastic threaded plugs, PG-7
		4	Nylon gland fittings, PG-7
		4	Hex nuts, PG-7
		1	Plug, 1/2" NPT
		1	Nylon gland fitting, 1/2" NPT
Mounting Hardware Kit	BWA-HW-001	4	Screw, M5-0.8 x 25mm, SS
		4	Screw, M5-0.8 x 16mm, SS
		4	Hex nut, M5-0.8mm, SS
		4	Bolt, #8-32 x 3/4", SS
PTFE Tape *	BWA-HW-003	1	PTFE Tape
SureCross Literature CD	79685	1	SureCross Literature CD
Cable	MQDC1-506	1	Cable, 5-pin Euro (single ended), Straight, 2m
	BWA-HW-011	1	IP20 Screw Terminal Headers (2 pack) (ships with DX85...C models only)

\* Not included with DX85...C models.



## Warnings

The manufacturer does not take responsibility for the violation of any warning listed in this document.

**Make no modifications to this product.** Any modifications to this product not expressly approved by Banner Engineering could void the user's authority to operate the product. Contact the Factory for more information.

**All specifications published in this document are subject to change.** Banner reserves the right to modify the specifications of products without notice. Banner Engineering reserves the right to update or change documentation at any time. For the most recent version of any documentation, refer to our website: [www.bannerengineering.com](http://www.bannerengineering.com). © 2006-2010 Banner Engineering Corp. All rights reserved.

## Limited Warranty

### Banner Limited Warranty

Banner Engineering Corp. warrants its products to be free from defects in material and workmanship for one year following the date of shipment. Banner Engineering Corp. will repair or replace, free of charge, any product of its manufacture which, at the time it is returned to the factory, is found to have been defective during the warranty period. This warranty does not cover damage or liability for misuse, abuse, or the improper application of the Banner product.

**THIS LIMITED WARRANTY IS EXCLUSIVE AND IN LIEU OF ALL OTHER WARRANTIES WHETHER EXPRESS OR IMPLIED (INCLUDING, WITHOUT LIMITATION, ANY WARRANTY OF MERCHANTABILITY OR FITNESS FOR A PARTICULAR PURPOSE), AND WHETHER ARISING UNDER COURSE OF PERFORMANCE, COURSE OF DEALING OR TRADE USAGE.**

This Warranty is exclusive and limited to repair or, at the discretion of Banner Engineering Corp., replacement. **IN NO EVENT SHALL BANNER ENGINEERING CORP. BE LIABLE TO BUYER OR ANY OTHER PERSON OR ENTITY FOR ANY EXTRA COSTS, EXPENSES, LOSSES, LOSS OF PROFITS, OR ANY INCIDENTAL, CONSEQUENTIAL OR SPECIAL DAMAGES RESULTING FROM ANY PRODUCT DEFECT OR FROM THE USE OR INABILITY TO USE THE PRODUCT, WHETHER ARISING IN CONTRACT OR WARRANTY, STATUTE, TORT, STRICT LIABILITY, NEGLIGENCE, OR OTHERWISE.**

Banner Engineering Corp. reserves the right to change, modify or improve the design of the product without assuming any obligations or liabilities relating to any product previously manufactured by Banner Engineering Corp.

## Contact Us

For more information: Contact your local Banner representative or Banner Corporate Offices around the world.

**Corporate Headquarters: Banner Engineering Corp.** 9714 Tenth Ave. North, Mpls., MN 55441, Tel: 763-544-3164, [www.bannerengineering.com](http://www.bannerengineering.com), [sensors@bannerengineering.com](mailto:sensors@bannerengineering.com)

**Europe: Banner Engineering Europe** Park Lane, Culliganlaan 2F, Diegem B-1831 BELGIUM, Tel: 32-2 456 07 80, Fax: 32-2 456 07 89, [www.bannereurope.com](http://www.bannereurope.com), [mail@bannereurope.com](mailto:mail@bannereurope.com)

**Latin America:** Contact Banner Engineering Corp. (US) or e-mail **Mexico:** [mexico@bannerengineering.com](mailto:mexico@bannerengineering.com); or **Brazil:** [brasil@bannerengineering.com](mailto:brasil@bannerengineering.com)

### Asia:

**Banner Engineering China** Shanghai Rep Office Rm. G/H/I, 28th Flr. Cross Region Plaza No. 899, Lingling Road, Shanghai 200030 CHINA, Tel: 86-21-54894500, Fax: 86-21-54894511, [www.bannerengineering.com.cn](http://www.bannerengineering.com.cn), [sensors@bannerengineering.com.cn](mailto:sensors@bannerengineering.com.cn)

**Banner Engineering Japan** Cent-Urban Building 305 3-23-15, Nishi-Nakajima Yodogawa-Ku, Osaka 532-0011 JAPAN, Tel: 81-6-6309-0411, Fax: 81-6-6309-0416, [www.bannerengineering.co.jp](http://www.bannerengineering.co.jp), [mail@bannerengineering.co.jp](mailto:mail@bannerengineering.co.jp)

**Banner Engineering Int'l Incorporated Taiwan Rep. Office** 8F-2, No. 308, Sec. 1, Neihu Rd. Taipei, Taiwan 114 Phone: +886 2 8751 9966 #15 | Fax: +886 2 8751 2966, [www.bannerengineering.com.tw](http://www.bannerengineering.com.tw), [info@bannerengineering.com.tw](mailto:info@bannerengineering.com.tw)

**Banner Engineering India** Pune Head Quarters Office, No. 1001 Sai Capital, Opp. ICC Senapati Bapat Road, Pune 411016 INDIA, Tel: 91-20-66405624, Fax: 91-20-66405623, [www.bannerengineering.com.in](http://www.bannerengineering.com.in), [india@bannerengineering.com](mailto:india@bannerengineering.com)