



SureCross™ DX80K Wireless Configured FlexPower™ Kit

I/O Repeater Kit with discrete inputs from Node (with switched power output) to other Node



Features

The SureCross™ DX80 is a radio frequency network system built around a Gateway and one or more Nodes. Configured kits are packaged in a box with the preset Gateway, Node(s), accessories, and hardware to get up and running quickly. In this configured kit, the Gateway functions as the I/O repeater.

- Kit contains a 10 to 30V dc Gateway, FlexPower™ Node, 10 to 30V dc Node, and DX81 FlexPower supply module for powering one Node and switched power output of discrete sensor
- Input-to-output mapping connects the one Node's discrete (sinking) inputs with the other Node's two discrete (sinking) outputs
- Node-to-Gateway-to-Node configuration extends the range of the wireless network
- Proprietary radio optimized for effective power management
- Frequency Hopping Spread Spectrum (FHSS) technology and Time Division Multiple Access (TDMA) control architecture combine to ensure reliable data delivery within the unlicensed Industrial, Scientific, and Medical (ISM) bands
- Transceivers provide two-way communication between the Gateway and Node, including fully acknowledged data transmission
- Site Survey analyzes the network's signal strength and reliability
- Lost RF links are detected and relevant outputs set to predefined conditions

For additional information and a complete list of accessories, including FCC approved antennas, please refer to Banner Engineering's website, www.bannerengineering.com/surecross.

Models

Model	Frequency	Power	I/O Mapping	I/O	Devices
DX80K9R3PE1	900 MHz ISM Band	10 to 30V dc (Gateway, Node)	Gateway as I/O Repeater	Discrete (Sinking)	1 Gateway, 2 Nodes
DX80K2R3PE1	2.4 GHz ISM Band	3.6V dc Battery (FlexPower Node)	(See hookup diagram)		1 Battery Module

⚠ WARNING . . . Not To Be Used for Personnel Protection

Never use these products for personnel protection. Doing so could lead to serious injury or death.

These products do NOT include the self-checking redundant circuitry necessary to allow their use in personnel safety applications. A failure or malfunction can cause either an energized or de-energized output condition. Consult your current Banner Safety Products catalog for safety products that meet OSHA, ANSI, and IEC standards for personnel protection.



SureCross™ DX80K Wireless Configured FlexPower™ Kit

Hookup Diagrams

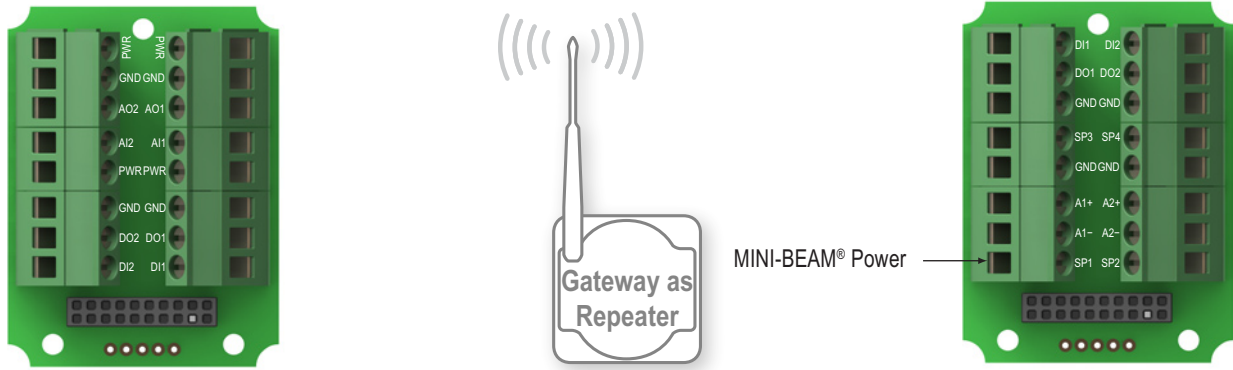

Preconfigured input/output mapping

I/O Point	Terminal Block Label	DX80 Node 1	DX80 Node 2	Terminal Block Label	I/O Point
9	DO1	Discrete OUT 1	Discrete IN 1	DI1	1
10	DO2	Discrete OUT 2	Discrete IN 2	DI2	2

← MINI-BEAM*

These are the I/O points as displayed on the device LCD. Any I/O points not shown in the chart are not enabled for this kit.

* Special low-power MINI-BEAM required when powered by the Node

5-pin Euro-style Hookup (RS-485)



Wire Color	Gateway	10–30V dc Node
1 Brown	+10 to 30V dc Input	+10 to 30V dc Input
2 White	RS485 / D1 / B / +	
3 Blue	dc common (GND)	dc common (GND)
4 Black	RS485 / D0 / A / -	
5 Gray	Comms grd	

* Connecting dc power to the communication pins will cause permanent damage.

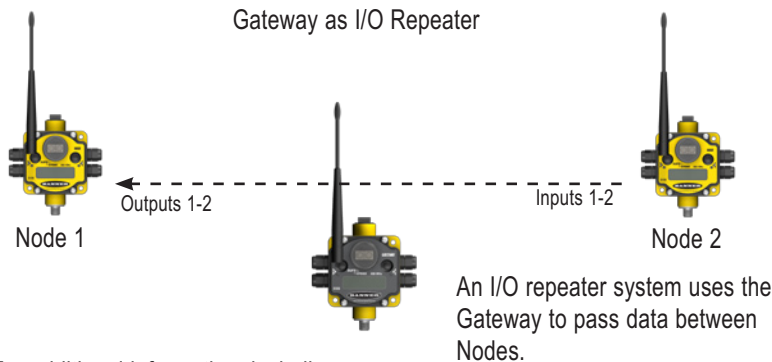

For additional information, including installation and setup, weatherproofing, device menu maps, troubleshooting, and a list of accessories, please refer to the SureCross™ DX80 Wireless I/O Network product manual, Banner part number 132607.

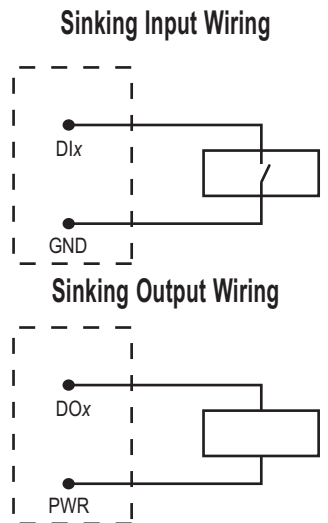

SureCross™ DX80K Wireless Configured FlexPower™ Kit

MINI-BEAM® Input Wiring

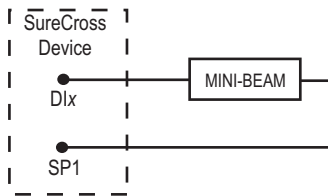

Sample and Report Rates

The sample rate defines how often the Node samples the sensor. The report rate defines how often the Node communicates the I/O status to the Gateway. For FlexPower™ applications, setting the sample and/or report rates to slower rates extends the battery life.

Change of state reporting sets the system to report only when the value crosses the threshold setting.

Configuration

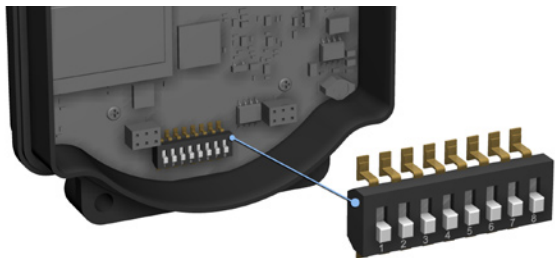

Device Settings	Switches	
	1	2
Rotary Switch Address Mode	OFF*	
Extended Address Mode	ON	
Analog Configuration		OFF
Discrete Configuration		ON*

* Default configuration

Accessing the DIP Switches

To access the DIP switches, follow these steps:

1. Unscrew the four screws that mount the cover to the bottom housing.
2. Remove the cover from the housing without damaging the ribbon cable or the pins the cable plugs into.
3. Gently unplug the ribbon cable from the board mounted into the bottom housing.
4. Remove the black cover plate from the bottom of the device's cover.

The DIP switches are located behind the rotary dials. After making the necessary changes to the DIP switches, place the black cover plate back into position and gently push into place. Plug the ribbon cable in after verifying that the blocked hole lines up with the missing pin. Mount the cover back onto the housing.

Analog or Discrete Configuration

Select between an analog configuration or a discrete configuration using the DIP switch specified in the table. The default switch settings for this device are all in the OFF position.

Cycle Power

After making any changes to the DIP switch positions, cycle power to the device to activate the changes. For devices with batteries integrated into the housing, remove the battery for one minute to cycle power to the device.

Do not change the position of any DIP switch other than DIP switches 1 and 2. This kit is configured at the factory.

Address Mode

The SureCross wireless devices may use one of two types of addressing modes: rotary switch addressing or extended addressing. In rotary switch address mode, the left rotary dial establishes the network ID and the right rotary dial sets the device ID. The wireless network is restricted to a maximum of 16 devices.

Extended address mode binds Nodes to a specific Gateway, allowing network expansion to more than 16 devices in a wireless network. For more information on extended address mode, refer to the SureCross™ Wireless I/O Network product manual.

The device ships in rotary switch address mode by default, with the DIP switch in the OFF position. To use extended address mode, change the DIP switch to the ON position.

Discrete Input Type

Select the discrete input type, sourcing (PNP) or sinking (PNP), using this DIP switch.

Boost Voltage

Select the boost voltage setting for the continuous power supplied to the sensor powered by this FlexPower Node.

Warm-Up Time

The warm-up time defines how long the device must power up the sensor before a stable sensor reading is taken.

Host Configured

Selecting "Host Configured (override switches)" uses the factory's default configuration for this device or allows a host system to set parameters. If the host configured option is not selected, use the DIP switches to configure the device parameters.

SureCross™ DX80K Wireless Configured FlexPower™ Kit

Discrete Configuration (default configuration)

The discrete configuration matches the switch power outputs (SP1, SP2) with the discrete inputs. The analog inputs are disabled. The discrete configuration is selected when switch 2 is in the ON position. Two sinking discrete outputs are active for this configuration.

Discrete Configuration, Switch 2 ON	DIP Switches					
	3	4	5	6	7	8
Discrete Sinking (NPN)	OFF*					
Discrete Sourcing (PNP)	ON					
Booster 5V		OFF*				
Booster 10V		ON				
Warm-up Time 4 milliseconds			OFF*			
Warm-up Time 10 milliseconds			ON			
Sample/Report Rate 62.5 milliseconds				OFF	OFF	OFF
Sample/Report Rate 125 milliseconds				OFF	OFF	ON
Sample/Report Rate 250 milliseconds*				OFF*	ON*	OFF*
Sample/Report Rate 500 milliseconds				OFF	ON	ON
Sample/Report Rate 1 second				ON	OFF	OFF
Sample/Report Rate 2 seconds				ON	OFF	ON
Host configured (override switches)				ON	ON	OFF
Sample/Report Rate 16 seconds				ON	ON	ON

Notes: Discrete IN 1 uses switched power 1 (SP1). Discrete IN 2 uses switched power 2 (SP2). Analog inputs 1 and 2 are disabled. (Default configuration for the PE1 kits)

Analog Configuration

For analog configuration, DIP switch 2 is in the OFF position. Analog configuration has analog IN 1 linked to switch power 1 (SP1) and is programmable using switches four through eight. Analog input 2 uses the report rate and sample intervals listed in the table below. Discrete inputs 1 and 2 are also active in this configuration and the input types are defined using switch 3. Two sinking discrete outputs are active for this configuration.

Analog Configuration, Switch 2 OFF	DIP Switches					
	3	4	5	6	7	8
Discrete Sinking (NPN)	OFF*					
Discrete Sourcing (PNP)	ON					
Booster 10V (Analog IN 1)		OFF*				
Booster 15V (Analog IN 1)		ON				
Warm-up Time 10 milliseconds			OFF*			
Warm-up Time 500 milliseconds			ON			
Sample/Report Rate 1 second				OFF	OFF	OFF
Sample/Report Rate 2 seconds				OFF	OFF	ON
Sample/Report Rate 4 seconds				OFF	ON	OFF
Sample/Report Rate 16 seconds				OFF	ON	ON
Sample/Report Rate 64 seconds				ON	OFF	OFF
Sample/Report Rate 5 minutes				ON	OFF	ON
Host configured (override switches)				ON	ON	OFF
Sample/Report Rate 15 minutes				ON	ON	ON

Analog IN 2, Discrete 1, and Discrete 2 are not powered from switched power terminals. In this configuration, SP2 is disabled. If you need SP2, contact the factory.

Rotary Dial Positions

Rotary Dial Addressing Mode

When using Rotary Dial Addressing Mode, the Gateway's and Node's rotary dials are in the correct position. The left rotary dial establishes the Network ID and the right dials establish the Device ID.

When using multiple networks within range of each other, set each network to a different Network ID using the left rotary dial. DO NOT change the position of the right rotary dials or your network and its preconfigured mapping will not work.

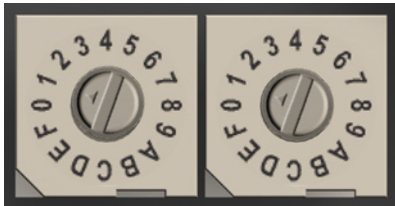

Gateway rotary dial positions, from the factory.

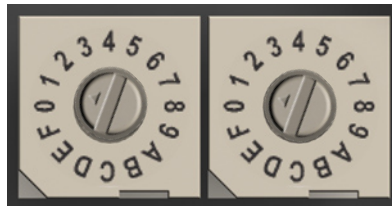

Node rotary dial positions, from the factory.

Extended Addressing and Binding Mode

When using binding to establish your networks, the rotary dial positions on the Gateway indicate which Node's I/O values are displayed on the Gateway's LCD. Adjust the left rotary dial to zero and the right rotary dial to one.

For the Nodes, set the left rotary dial position to zero, and DO NOT change the position of the right rotary dial or your network and its preconfigured mapping will not work.

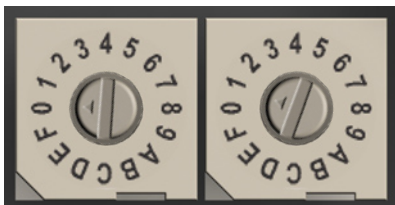

Gateway rotary dial positions.

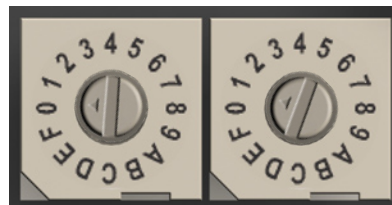

Node 1's rotary dial positions.

Do not change the position of the right rotary dial on the Node(s) in this kit. The factory configured this kit and assigned a device ID to the Node(s) based on the kit configuration requirements. If you change the Node's right rotary dial, your kit will not work.

SureCross™ DX80K Wireless Configured FlexPower™ Kit

Specifications

Many parameters are configurable. The values in the tables represent factory defaults unless otherwise noted.

Radio

Range*	900 MHz: Up to 4.8 kilometers (3 miles) 2.4 GHz: Up to 3.2 kilometers (2 miles)
Transmit Power	900 MHz: 21 dBm Conducted 2.4 GHz: 18 dBm Conducted, ≤ 20 dBm EIRP
Spread Spectrum Technology	FHSS (Frequency Hopping Spread Spectrum)
Antenna Connector	Ext. Reverse Polarity SMA, 50 Ohms
Antenna Max. Tightening Torque	0.45 N•m (4 in•lbf)
Link Timeout	64 seconds

* With the standard 2 dB antenna. High-gain antennas are available, but the range depends on the environment and line of sight. To determine the range of your wireless network, perform a Site Survey.

General

Power*	Gateway and Node: +10 to 30V dc (For European applications: +10 to 24V dc, ± 10%) FlexPower™ Node: +3.6 to 5.5V dc low power option
Power Consumption	Less than 1.4 W (60 mA) at 24V dc
Mounting	#10 or M5 (M5 hardware included)
M5 Fasteners Max. Tightening Torque	0.56 N•m (5 in•lbf)
Case Material	Polycarbonate
Weight	0.26 kg (0.57 lb.)
Indicators	Two LED, bi-color
Switches	Two Push Buttons
Display	Six Character LCD
External Cable Glands	Four PG-7 type, One 1/2-inch NPT type
Cable Glands Max. Tightening Torque	0.56 N•m (5 in•lbf)

* For European applications, power the DX80 from a Limited Power Source as defined in EN 60950-1.

Inputs

Discrete Inputs	Two Sinking
Discrete Input Rating	3 mA max current at 30V dc
Discrete Input 1 Sample Rate	250 milliseconds (switch selectable)
Discrete Input 2 Sample Rate	250 milliseconds (switch selectable)
Discrete Input 1,2 Report Rates	On Change of State
Discrete Input ON Condition	Less than 0.7V
Discrete Input OFF Condition	Greater than 2V or Open
Switched Power for Input 1	5V

SureCross™ DX80K Wireless Configured FlexPower™ Kit

Outputs

Discrete Outputs	Two NMOS Sinking
Discrete Output Rating	Less than 10 mA max current at 30V dc ON-State Saturation: Less than 0.7V at 20 mA
Discrete Output ON Condition	Less than 0.7V
Discrete Output OFF Condition	Open
Maximum End-to-end Latency (Repeater)*	250 milliseconds
Output State Following Timeout	De-energized (OFF)

* From the sample point and with a good RF signal.

Environmental

Environmental Rating*	IEC IP67; NEMA 6
Operating Temperature**	-40 to +85° C (Electronics); -20 to +80° C (LCD)
Operating Humidity	95% max. relative (non-condensing)
Radiated Immunity	10 V/m, 80-2700 MHz (EN61000-6-2)
Shock and Vibration	IEC 68-2-6 and IEC 68-2-7 Shock: 30g, 11 millisecond half sine wave, 18 shocks Vibration: 0.5 mm p-p, 10 to 60 Hz

* Please refer to the SureCross™ DX80 Wireless I/O Network product manual, Banner p/n 132607, for installation and waterproofing instructions.

** Operating the devices at the maximum operating conditions for extended periods can shorten the life of the device.

Certifications, Radio

900 MHz Models	FCC ID TGUDX80: This device complies with FCC Part 15, Subpart C, 15.247 IC: 7044A-DX8009	CE
2.4 GHz Models	FCC ID UE300DX80-2400: This device complies with FCC Part 15, Subpart C, 15.247 ETSI/EN: In accordance with EN 300 328: V1.7.1 (2006-05) IC: 7044A-DX8024	CE

It is Banner Engineering's intent to fully comply with all national and regional regulations regarding radio frequency emissions. Customers who want to re-export this product to a country other than that to which it was sold must ensure that the device is approved in the destination country. A list of approved countries appears in the SureCross DX80 Wireless Product Manual, in the Agency Certifications section. Consult with Banner Engineering if the destination country is not on this list.

SureCross™ DX80K Wireless Configured FlexPower™ Kit

For more information: Contact your local Banner representative or Banner Corporate Offices around the world.	Corporate Headquarters	Europe	Latin America
	Banner Engineering Corp. 9714 Tenth Ave. North Mpls., MN 55441 Tel: 763-544-3164 www.bannerengineering.com sensors@bannerengineering.com	Banner Engineering Europe Park Lane Culliganlaan 2F Diegem B-1831 BELGIUM Tel: 32-2 456 07 80 Fax: 32-2 456 07 89 www.bannereurope.com mail@bannereurope.com	Contact Banner Engineering Corp. (US) or e-mail Mexico: mexico@bannerengineering.com Brazil: brasil@bannerengineering.com
Asia — China	Asia — Japan	Asia	India
Banner Engineering China Shanghai Rep Office Rm. G/H/I, 28th Flr. Cross Region Plaza No. 899, Lingling Road Shanghai 200030 CHINA Tel: 86-21-54894500 Fax: 86-21-54894511 www.bannerengineering.com.cn sensors@bannerengineering.com.cn	Banner Engineering Japan Cent-Urban Building 305 3-23-15 Nishi-Nakajima Yodogawa-Ku, Osaka 532-0011 JAPAN Tel: 81-6-6309-0411 Fax: 81-6-6309-0416 www.bannerengineering.co.jp mail@bannerengineering.co.jp	Banner Engineering Asia — Taiwan Neihu Technology Park 5F-1, No. 51, Lane 35, Jihu Rd. Taipei 114 TAIWAN Tel: 886-2-8751-9966 Fax: 886-2-8751-2966 www.bannerengineering.com.tw info@bannerengineering.com.tw	Banner Engineering India Pune Head Quarters Office No. 1001 Sai Capital, Opp. ICC Senapati Bapat Road Pune 411016 INDIA Tel: 91-20-66405624 Fax: 91-20-66405623 www.bannerengineering.co.in india@bannerengineering.com

The manufacturer does not take responsibility for the violation of any warning listed in this document.



CAUTION . . .

Make no modifications to this product.

Any modifications to this product not expressly approved by Banner Engineering could void the user's authority to operate the product. Contact the Factory for more information.

Always use lightning arrestors/surge protection with all remote antenna systems to avoid invalidating the Banner Engineering Corp. warranty. No surge protector can absorb all lightning strikes. Do not touch the SureCross device or any equipment connected to the SureCross device during a thunderstorm.

WARRANTY: Banner Engineering Corp. warrants its products to be free from defects for one year. Banner Engineering Corp. will repair or replace, free of charge, any product of its manufacture found to be defective at the time it is returned to the factory during the warranty period. This warranty does not cover damage or liability for the improper application of Banner products. This warranty is in lieu of any other warranty either expressed or implied.

All specifications published in this document are subject to change. Banner reserves the right to modify the specifications of products, prior to their order, without notice. Banner Engineering reserves the right to update or change documentation at any time. For the most recent version of any documentation, please refer to our website: www.bannerengineering.com. © 2007 Banner Engineering Corp. All rights reserved.