

# **PresencePLUS<sup>®</sup> P4 EDGE/EDGE 1.3**

## **User's Manual**

**Banner Engineering Corp.**  
P/N 120413 rev. D — 2009R2



---

# Table of Contents

<b>1. Product Support and Maintenance</b> .....	<b>7</b>
1.1 Product Support.....	7
1.2 Maintenance.....	8
<b>2. System Description</b> .....	<b>9</b>
2.1 P4 Vision Sensors.....	9
2.1.1 Typical P4 Vision Application.....	9
2.1.2 PresencePLUS® P4 Components.....	10
2.1.3 P4 Cable Connections.....	11
2.2 Software Overview.....	12
2.2.1 Main Menu Toolbar .....	13
2.2.2 Image Window.....	14
2.2.3 Navigation/Results Window.....	15
2.2.4 Configuration Window.....	17
2.2.5 Status Window.....	17
<b>3. Getting Started</b> .....	<b>19</b>
3.1 Installing the PresencePLUS Software.....	19
3.1.1 Installing the Software.....	19
3.1.2 Starting Up the Software.....	19
3.2 Typical Setup and Startup Sequence.....	24
3.3 Startup and Troubleshooting.....	24
3.3.1 General Troubleshooting.....	25
3.4 Setting Up Hardware Parameters.....	26
3.5 Building an Inspection.....	26
<b>4. Setup</b> .....	<b>29</b>
4.1 Setup Screen.....	29
4.2 Capturing a Reference Image.....	29
4.3 Focus Tab.....	29
4.3.1 Reference Image Source.....	30
4.3.2 Focus Value.....	31
4.3.3 Auto Exposure.....	31
4.4 Trigger Tab.....	32
4.4.1 Trigger Settings.....	33
4.4.2 Resolution.....	34
4.5 Advanced Tab.....	34
<b>5. Tools Screen</b> .....	<b>37</b>
5.1 Overview.....	37
5.2 Typical Build/Modify Procedure.....	38
5.2.1 Choosing a Tool.....	38
5.2.2 Adding a Tool.....	38
5.2.3 Adding a Test Tool.....	38
5.2.4 Renaming Tools.....	38
5.2.5 Removing a Tool.....	39
5.3 Quick Teach.....	39
5.4 Load Tab.....	39

5.4.1 Flexible Inspection Loading.....	40
5.4.2 Inspection Storage Capacity.....	41
5.4.3 Opening an Inspection from the Sensor or a Library.....	42
<b>6. System Setup Window Overview.....</b>	<b>45</b>
6.1 Sensor Select Tab.....	46
6.1.1 Change Sensor IP Address.....	48
6.1.2 PC (GUI) to Sensor Connection Setup.....	49
6.1.3 IP Address History.....	50
6.2 Communication Tab.....	51
6.2.1 Communication Setup.....	52
6.2.2 Remote Command Channel Configuration .....	56
6.2.3 PresencePLUS/Kawasaki Vision Guidance and Inspection.....	65
6.2.4 Using Custom_ASCII to Communicate with an External Device Over Ethernet.....	81
6.3 P4 Input/Output Tab.....	82
6.4 Strobe Tab.....	84
6.4.1 Strobe Width.....	84
6.4.2 Level.....	85
6.5 Units Tab.....	85
6.6 Reset Tab.....	86
6.7 Start-Up Inspection Tab.....	87
6.8 NTSC Tab.....	89
6.9 Language Tab.....	90
6.10 Tools Configuration.....	91
6.10.1 Standard Mode.....	92
6.10.2 Enhanced Mode.....	92
6.10.3 Custom Mode.....	92
6.10.4 Tool Licensing.....	92
<b>7. PresencePLUS Software Tools.....</b>	<b>95</b>
7.1 ROI Types.....	95
7.1.1 Linear ROI.....	95
7.1.2 Area ROI.....	95
7.1.3 Search ROI.....	96
7.2 Location Tools.....	96
7.2.1 Locate Tool.....	96
7.3 Vision Gray Scale Tools.....	103
7.3.1 Edge Tool.....	104
7.3.2 Object Tool.....	111
7.4 Analysis Tools.....	120
7.4.1 Communication Tool.....	121
7.4.2 Coordinate Tool.....	137
7.4.3 Math Tool.....	140
7.4.4 Measure Tool.....	145
7.4.5 Test Tool.....	166
<b>8. Communication Tool Setup.....</b>	<b>187</b>
8.1 Ethernet Connection.....	187
8.2 Serial Connection.....	189
8.3 Overview of Testing the Communication Tool.....	190
8.4 Detailed Steps for Testing the Communication Tool.....	191
8.4.1 Testing Ethernet Communications.....	191
8.4.2 Testing Serial Communications.....	191
8.5 Troubleshooting Ethernet Connections.....	192

8.6 Troubleshooting Serial Connections.....	192
8.7 Remote Command Channel Configuration .....	193
8.7.1 Remote Command Set .....	193
8.7.2 RCC Return Values.....	196
8.7.3 Frame Tag Numbers .....	197
8.7.4 Command Processing .....	198
8.7.5 RCC Log .....	198
8.7.6 Frame and Field Delimiters.....	199
<b>9. Teach.....</b>	<b>201</b>
9.1 Quick Teach.....	201
9.2 Teach.....	201
9.3 Teach Screen.....	202
9.3.1 Teaching an Inspection.....	202
9.4 Remote Teach.....	204
9.4.1 Understanding Remote Teach.....	204
9.4.2 Remotely Teaching a Tool.....	205
9.4.3 Timing Sequence.....	205
9.4.4 Remote Teach Results.....	206
<b>10. Run Screen.....</b>	<b>207</b>
10.1 Selected Inspection.....	208
10.2 Display.....	208
10.3 Capture Control.....	209
10.4 Results.....	209
10.5 Inputs.....	210
10.6 Outputs.....	210
10.7 Product Select.....	211
10.8 System.....	211
10.9 Start/Stop.....	211
10.10 Select Tab.....	211
10.11 Log Tab.....	213
10.12 Run Results.....	215
10.13 Run Player/Recorder.....	217
10.13.1 Record.....	219
10.13.2 Playback.....	221
<b>11. Product Change.....</b>	<b>225</b>
11.1 Product Change Specifications.....	225
11.2 Product Select Input Specifications.....	226
<b>12. P4 Product Change and Product Select Timing.....</b>	<b>227</b>
12.1 One Pulse Set Overview.....	227
12.1.1 Product Select in One-Pulse Configuration.....	228
12.2 Three Pulse Set Overview.....	229
12.2.1 Product Select in Three-Pulse Configuration.....	229
<b>13. Saving Inspections.....</b>	<b>231</b>
13.1 Saving Inspections to a Vision Sensor.....	232
13.2 Saving Inspections to a PC or Network Drive.....	234
<b>14. Backing Up and Restoring Vision Sensor Data.....</b>	<b>235</b>
14.1 Backing up Vision Sensor Data.....	235
14.2 Restoring Vision Sensor Data.....	239

**15. Dimensions and Specifications.....243**

- 15.1 Sensor Dimensions..... 243
  - 15.1.1 Right-Angle Sensor Dimensions..... 243
  - 15.1.2 Right-Angle Sensor Mounting Bracket Dimensions..... 243
  - 15.1.3 In-Line Sensor Dimensions..... 244
  - 15.1.4 In-Line Sensor Mounting Bracket Dimensions..... 244
- 15.2 Sensor Specifications..... 245
- 15.3 Monitor Specifications - 9" CRT..... 247
- 15.4 Monitor Specifications - Flat Panel 8" LCD Color..... 247
- 15.5 Ethernet Communication Specifications..... 248
- 15.6 Serial Port Communication Specifications..... 249

.....**251**

---

# Product Support and Maintenance

This section provides general Banner resources and specific documentation for installers and operators of this *PresencePLUS* Vision Sensor.



**Attention: Not to be Used for Personal Protection.**

**Never use these products as sensing devices for personnel protection. Doing so could lead to serious injury or death.**

These sensors do NOT include the self-checking redundant circuitry necessary to allow their use in personnel safety applications. A sensor failure or malfunction can cause either an energized or de-energized sensor output condition. Consult your current Banner Safety Products catalog for safety products which meet OSHA, ANSI, and IEC standards for personnel protection.

## 1.1 Product Support

Banner provides the following resources for quickly setting up and operating the sensor.

### Documentation

#### Online Help

The *PresencePLUS* online help is available from the from the Help menu item within the *PresencePLUS* software. You can also get targeted help while on any system tab or dialog by pressing the <F1> key.

#### PDF Documentation

The *PresencePLUS* Sensor documentation is available in a convenient printable format (PDF) on the installation CD or on the [Banner Web site](#)

#### Banner Website

The most current *PresencePLUS* information, documentation, and software updates are available at the following Banner website page:

[www.bannerengineering.com](http://www.bannerengineering.com)

#### Warranty Service

The *PresencePLUS* Vision Sensor is designed for reliability. Do not open the housing; it contains no field-replaceable components. If repair is necessary, do not attempt to repair the sensor yourself; return the unit to the factory. Should it become necessary to return a sensor to the factory, please do the following:

1. Contact the Banner Factory Application Engineering group at the address or numbers listed below. They will attempt to trouble shoot the system from your description of the problem. If they conclude that a component is defective, they will issue an RMA (Return Merchandise Authorization) number for your paperwork and give you the proper shipping address.

2. Pack the sensor carefully. Damage which occurs during return shipping is not covered by warranty.

### Factory Support

Call, e-mail, fax, or write your local Banner representative or a Banner Applications Engineer for support. Applications Engineers are available from 8:00 A.M. to 5:00 P.M. Central Time, Monday through Friday, excluding holidays.

<b>Phone</b>	Local: 763.544.3164 Toll Free: 1.888.3.SENSOR (1.888.373.6767)
<b>Fax</b>	763.544.3213
<b>E-mail</b>	sensors@bannerengineering.com
<b>Address</b>	Banner Engineering Corp. 9714 10th Avenue North, Minneapolis, MN 55441 USA

To help Banner better assist you, be ready to provide the following information:

- PresencePLUS software version (to find version number, click Help in the Main Menu toolbar and choose About)
- Operating system of your PC
- Sensor Model Number and Date Code. Model Number is on top of Sensor, Date Code is either on the bottom or the side
- Exact wording of any messages that appeared on your screen
- A description of what you were doing and what happened
- A description of how you tried to solve the problem

## 1.2 Maintenance

Maintenance tasks include keeping the hardware free of dust and dirt and possibly updating the PresencePLUS software as new versions become available.

### Cleaning the Sensor

Regularly remove any dust or dirt from the Sensor using a soft cloth. If needed, slightly dampen the cloth with a weak solution of neutral detergent. Avoid getting dirt on the imager (the area behind the lens). If the imager is dirty, use anti-static compressed air to blow off the dust.

### Cleaning the Lens

Regularly remove dust, dirt, or fingerprints from the lens. Use anti-static compressed air to blow off dust. If necessary, use a lens cloth and lens cleaner or window cleaner to wipe off remaining debris.

Do not use any other chemicals for cleaning.

### Updating the PresencePLUS Software

The current version of PresencePLUS software is available for download from the Banner website. See Banner Website for the software downloads link.



---

# System Description

The *PresencePLUS* ProII and P4 sensor families are easy-to-use camera systems with advanced visual inspection capability. With minimal knowledge of vision systems, a user can quickly set up a *PresencePLUS* ProII or P4 and run an inspection that tests products accurately, rejecting bad products on a production line.

Inspections are set up using a personal computer (PC). A digital camera inside the Vision sensor captures images, and the sensor software analyzes the images using one or more Vision tools to pass or fail the product. The PC is not required for running inspections after the inspection files have been stored in the sensor's memory.

Inspection setup involves focusing the camera and selecting the appropriate Location, Vision, and Analysis tools. The full range of inspection tolerances can be established either automatically or manually. The automatic Teach function eliminates the iterative process of determining correct tolerances.

The *PresencePLUS* ProII and P4 Sensor families accommodate both translational and rotational variation. Parts moving down a production line or web need not be oriented in exactly the same way.

The Sensor is easy to operate, with both basic and advanced options. New users can follow the guided Setup sequence. Advanced users can override automatic settings and create highly customized inspections.

## 2.1 P4 Vision Sensors

### 2.1.1 Typical P4 Vision Application

A typical *PresencePLUS* P4 application is shown below.

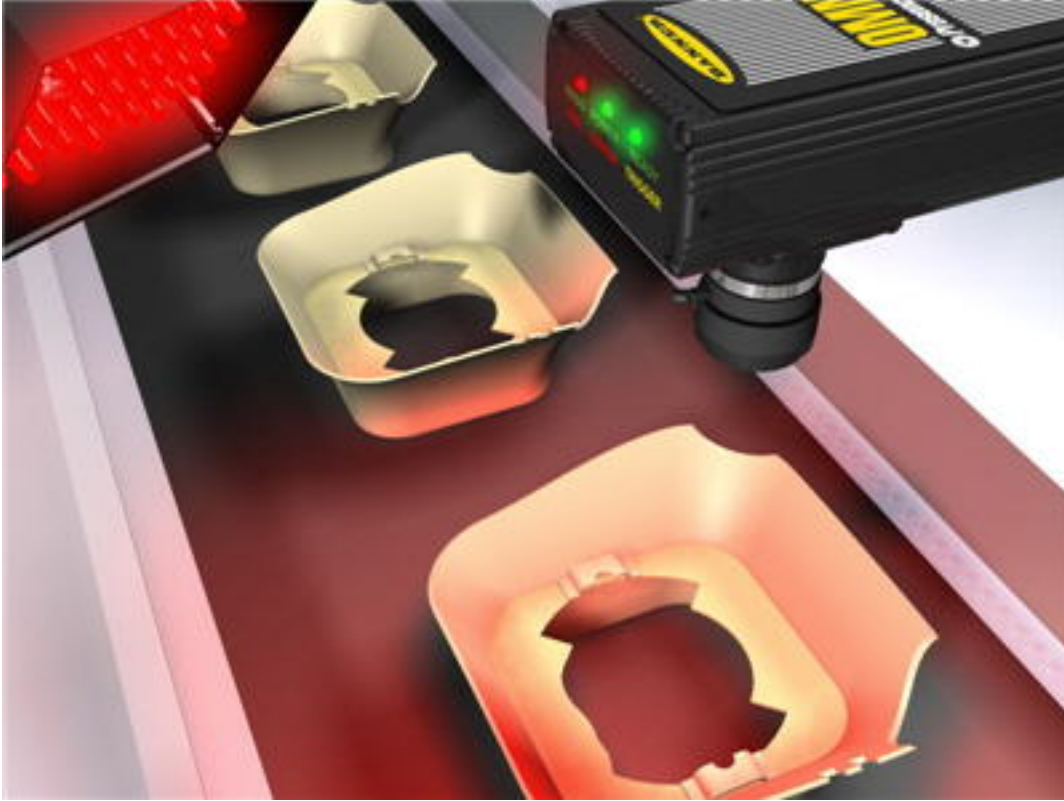

In the application shown above, as each plastic formed part comes past the Vision sensor, an inspection is performed. If the part is not shaped correctly as shown here, the inspection fails.

### 2.1.2 PresencePLUS® P4 Components

The *PresencePLUS* P4 system consists of the Sensor and a PC with *PresencePLUS* software and the appropriate connections. The Sensor requires lighting and a trigger device, and an optional video monitor can be connected.

- 👉 **Note:** The trigger device can be any 10-30V dc photoelectric sensor (PNP or NPN) or a device with a similar output.

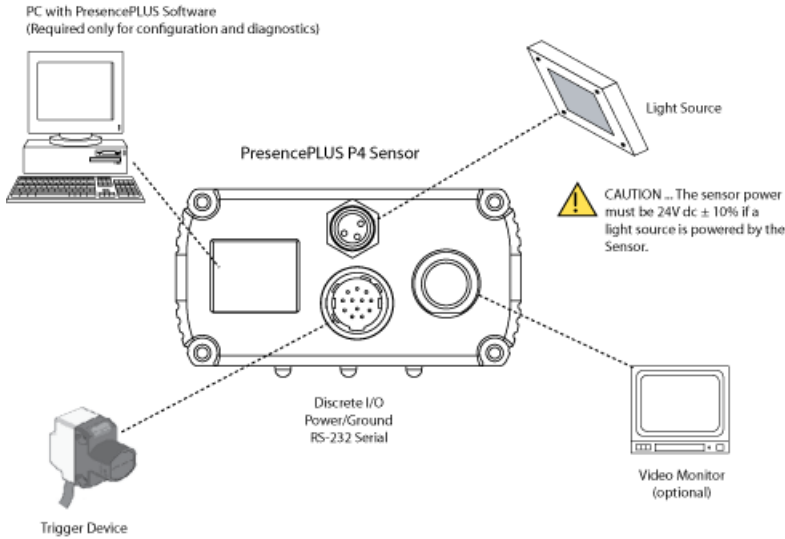

### 2.1.3 P4 Cable Connections

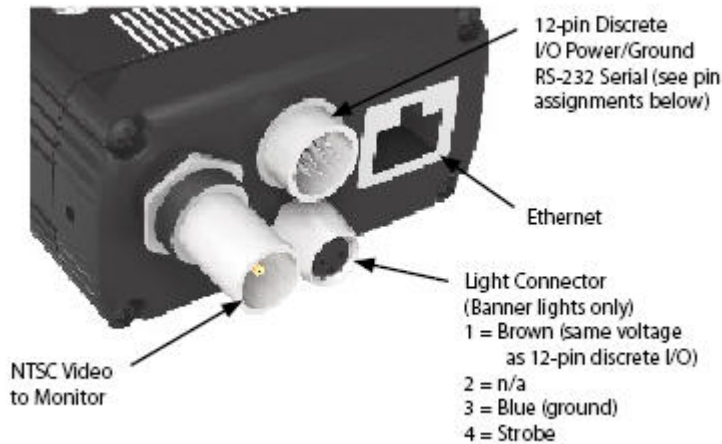

**Note:** The sensor power must be 24V dc  $\pm$  10% if a light source is powered by the sensor.

<p><b>Crossover Ethernet Cable (to PC Ethernet Port)*</b>  <b>STPX07</b> — 2.1 m (7')  <b>STPX25</b> — 7.6 m (25')</p> <p>or</p> <p><b>Standard Ethernet Cable (to PC via Network Hub or Switch)</b>  <b>STP07</b> — 2.1 m (7')</p>	<p><b>Monitor Cable (to Video Monitor, optional)</b>  <b>BNC06</b> — 2 m (6')  <b>BNC15</b> — 5 m (15')  <b>BNC30</b> — 9 m (30')</p> <p><b>Serial Cable (to PC serial Port)*</b>  <b>DB9P06</b> — 2 m (6')  <b>DB9P15</b> — 5 m (15')</p>
---	--

STP25 — 7.6 m (25')

DB9P30 — 9 m (30')

\*The Sensor can be connected to the PC via a serial cable or an Ethernet network; Ethernet provides faster communication.

Pin #	Wire Color	Description	Direction
1	Yellow	RS-232 TX**	Output
2	Gray	Remote Teach	Input
3	Orange	Product Change	Input
4	Pink	External Trigger	Input
5	Black	Discrete I/O #1	In/Out
6	Red	Discrete I/O #2	In/Out
7	White	Discrete I/O #3	In/Out
8	Light Blue	Discrete I/O #4	In/Out
9	Violet	RS-232 RX**	Input
10	Green	RS-232 Signal Ground**	Output
11	Blue	Common (Signal Ground)	Input
12	Brown	10-30V dc	Input

\*\* These three wires make up the RS-232 serial connection.

 **Note:** All unused inputs and outputs should be connected to ground if configured as PNP, and connected to +24V dc if configured as NPN. Serial input pins should be connected to ground.

## 2.2 Software Overview

The *PresencePLUS* application window is shown below.

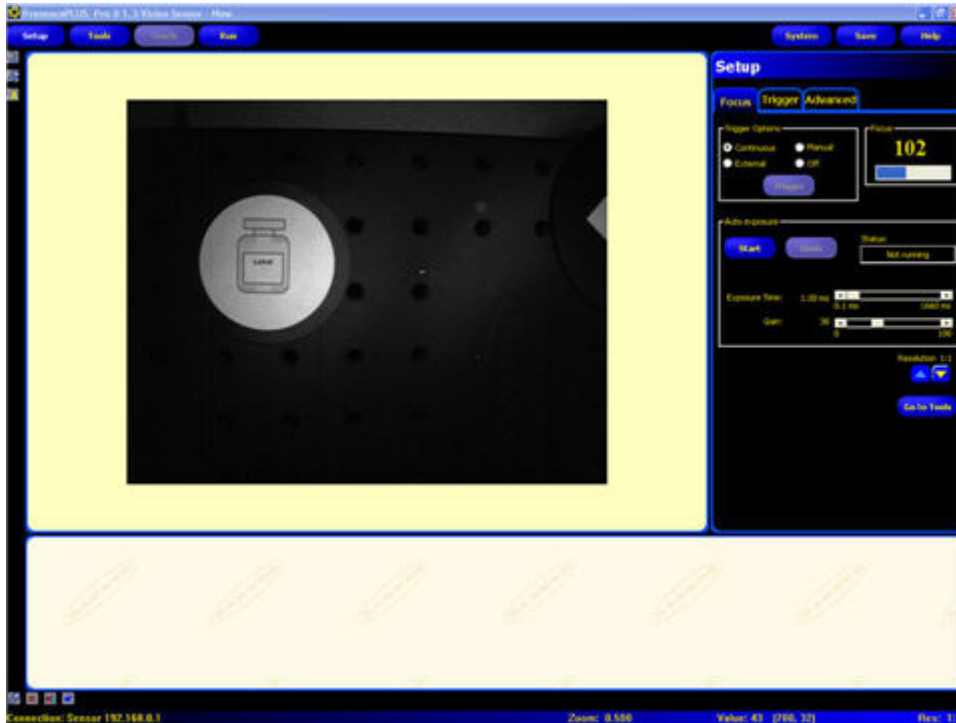

## 2.2.1 Main Menu Toolbar

Use the Main Menu toolbar to navigate between the Sensor options. Proceeding from left to right, the buttons in the Main Menu toolbar step through the process of creating and controlling an inspection. Each button is explained in the illustration below and in the table that follows.



The following table describes the screen associated with each button in the Main Menu.

Inspection-Specific Screens	
<b>Setup</b>	Set up the camera, lens, trigger, and lighting to acquire images. Create a reference image to be used later.
<b>Tools</b>	Add tools to an inspection. Build the inspection from scratch, or load tools from a previous inspection file saved on the controller or a PC.
<b>Teach</b>	Teach the Sensor good products. This screen automatically configures the parameters chosen in the Tools screen.
<b>Run</b>	Choose which inspection file the Sensor will run, and view the results of the inspection
System-Wide Screens	
<b>System</b>	Set up the discrete inputs and outputs and communication configuration. This screen also has the Sensor diagnostic tools.
<b>Save</b>	Name the current inspection files and save them to the controller or a PC for future use.



Inspection-Specific Screens	
Help	Call the Help window or the About window.

## 2.2.2 Image Window

The Image window, on the left side of the screen, displays images acquired from the camera or the reference image that is set for the current inspection. The toolbar buttons in the Image window are explained below.



 **Note:** The reference image is used as a template for developing an inspection; it establishes the initial values for the Vision tools. The reference image also is used by Quick Teach.

Icon	Description
	<b>Zoom</b> -- toggles zoom control. When enabled, click on the image window to zoom in and right-click to zoom out. This button is active when an image is displayed in the Image window.
	<b>Expand Image</b> -- toggles the size of the Image window between maximum and minimum.
	<b>Selected ROI / ALL ROIs</b> -- toggles between the currently <b>S</b> elected Region of Interest (ROI) and <b>A</b> ll ROIs.

## 2.2.3 Navigation/Results Window

The Navigation/Results window, at the bottom of the screen, displays tool navigation buttons or inspection results files.

### Navigation Buttons

Clicking on the Tools button in the Main Menu toolbar brings up the tool navigation buttons in the Navigation/Results window. When setting up or using tools, click on any tool navigation button to get the corresponding tab in the Configuration window.



LOCATE_1 (or BLOB_1)	Tool name
A	Absolute
R	Relative
Locate (or Blob)	Tool type

### Absolute and Relative Tools

An absolute tool's Region of Interest (ROI) does not move in the image window. A relative tool shifts the ROI from the previous tool, relative to the position of the part.



The Location tools (for example, Locate) track parts in the Image window, and the Vision tools that follow (for example, Average Gray Scale and Blob Detect) are relative. A Vision tool that precedes all Location tools will be absolute. Rules governing whether a tool is absolute or relative are as follows:

- The first Location tool is always absolute.
- All tools following a Location tool are relative to that tool unless they are made absolute themselves, in which case the chain is broken, and a new chain is started.
- For a Vision tool to be absolute, it must be placed before any Location tools.

### Navigation/Results Toolbar Buttons

Using the Navigation/Results toolbar buttons, the Navigation/Results window size can be set, and tools can be deleted.

Icon	Description
	<b>Expand Results</b> -- toggles the size of the Navigation/Results window between maximum and minimum.

Icon	Description
	<b>Delete Selected Tool</b> -- deletes the selected tool from the current inspection.
	<b>Delete Selected Tools</b> -- deletes the selected tool and all the tools to the right of the selected tool.
	<b>Copy Selected Tool</b> -- clones the selected tool.

## Expand Button

Clicking on the Expand button () toggles the size of the Navigation/Results window to accommodate an expanded list of inspection results files, as shown below.

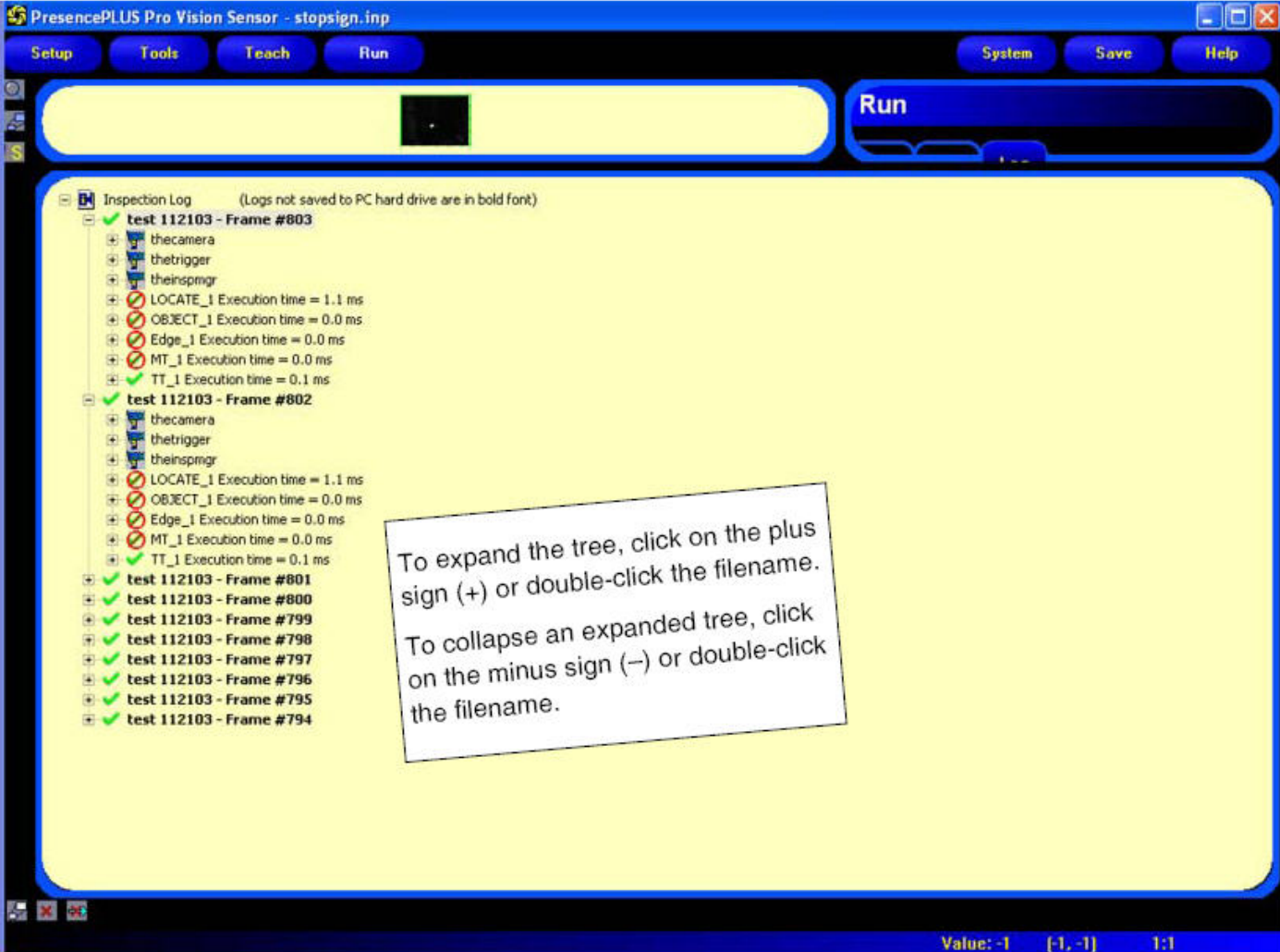

PresencePLUS Pro Vision Sensor - stopsign.inp

Setup Tools Teach Run System Save Help

Run

Inspection Log (Logs not saved to PC hard drive are in bold font)

- test 112103 - Frame #803
  - thecamera
  - thetrigger
  - theinsprgr
  - LOCATE\_1 Execution time = 1.1 ms
  - OBJECT\_1 Execution time = 0.0 ms
  - Edge\_1 Execution time = 0.0 ms
  - MT\_1 Execution time = 0.0 ms
  - TT\_1 Execution time = 0.1 ms
- test 112103 - Frame #802
  - thecamera
  - thetrigger
  - theinsprgr
  - LOCATE\_1 Execution time = 1.1 ms
  - OBJECT\_1 Execution time = 0.0 ms
  - Edge\_1 Execution time = 0.0 ms
  - MT\_1 Execution time = 0.0 ms
  - TT\_1 Execution time = 0.1 ms
- test 112103 - Frame #801
- test 112103 - Frame #800
- test 112103 - Frame #799
- test 112103 - Frame #798
- test 112103 - Frame #797
- test 112103 - Frame #796
- test 112103 - Frame #795
- test 112103 - Frame #794

To expand the tree, click on the plus sign (+) or double-click the filename.  
To collapse an expanded tree, click on the minus sign (-) or double-click the filename.

Value: -1 [-1, -1] 1:1



### 2.2.4 Configuration Window

The Configuration window, on the right side of the screen, displays the currently selected options with multiple tabs. Clicking the Setup, Tools, Teach, Run, System, Save, or Help buttons on the Main Menu toolbar changes the contents of the Configuration window accordingly.

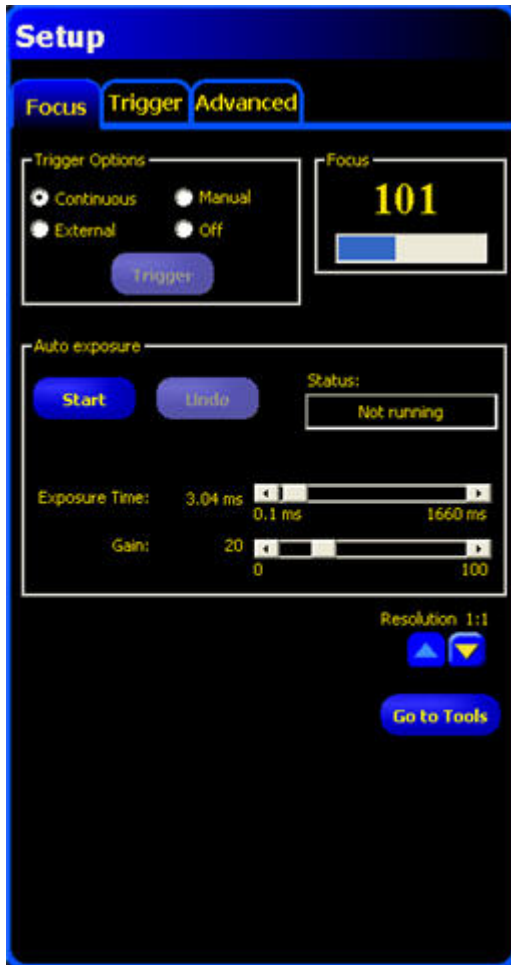

### 2.2.5 Status Window

The Status window, shown below, provides the following Sensor feedback.

**Connection: Sensor 192.168.0.1**      **Zoom: 0.500**      **Value: 5 [950, 958]**      **Res: 1:1**

The following table provides descriptions of each region in the Status window:

Region	Description
<b>Connection: Sensor 192.168.0.1</b>	<b>Connection info</b> -- current sensor to which the PC is connected.

Region	Description
	<b>Image update completion</b> -- progress bar shows relative image update completion when an image is being transferred from the camera to the PC (this flickers, and is next to Connection: Sensor 192.168.0.1).
<b>Zoom: 0.500</b>	<b>Current zoom value</b> - works with the Zoom icon (magnifying glass).
<b>Value: 8</b>	<b>Current grayscale value</b> -- the 0-255 gray scale value of the pixel under the cursor.
<b>[876, 604]</b>	<b>Cursor position</b> -- displays the x, y coordinates of the pixel under the cursor relative to the upper-left corner (origin, which is 0,0) of the field of view. Note that you must have the mouse pointer hovering over the image to get this information, otherwise, it displays (-1,-1).
<b>Res: 1:1</b>	<b>Current image display resolution</b> -- displays the user-specified value, which can be from 1:1 to 64:1. Note that this does not affect how the sensor operates; it only affects sensor-to-GUI image communication speed, and is more useful when using Serial communication.

---

# Getting Started

This section begins with some Vision basics, then provides a brief overview of how to install the software, and the general steps to creating an inspection.

## 3.1 Installing the *PresencePLUS* Software

The *PresencePLUS* software CD includes the sensor software and this documentation.

### 3.1.1 Installing the Software

To install the *PresencePLUS* software:

1. Close all active programs.
2. Make sure that no previous installations of *PresencePLUS* are installed.
3. Insert the *PresencePLUS* CD into the CD ROM drive of the personal computer. If you have auto-start enabled, the CD should automatically start. If it doesn't start --
  - a. Double-click on the **My Computer** icon on the desktop.
  - b. Double-click on the **CD Drive** in the list that appears.
  - c. Double-click on the **PresencePLUS** autorun file.
4. When the Install screen appears, click *PresencePLUS* PC Software.
5. Follow the instructions on the screen.
6. When the installation completes, reboot the PC.

### 3.1.2 Starting Up the Software

1. Power up the PC.
2. Install the software if it has not been installed. The installation screen of the *PresencePLUS* Pro software CD is shown below.



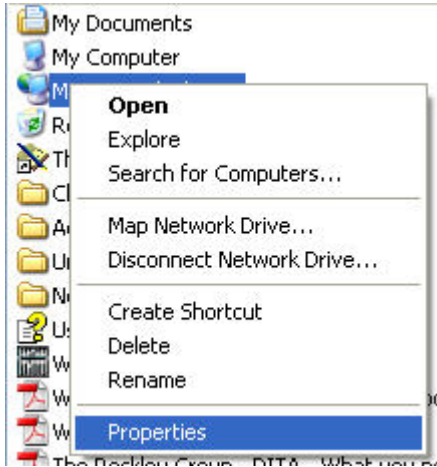

 **Note:** The following instructions assume you are installing the software on Windows XP.

3. If using an Ethernet communication cable, configure the IP address as follows:
  - a. Open **Network Properties** on the PC (right-click on the **Network Neighborhood** icon).

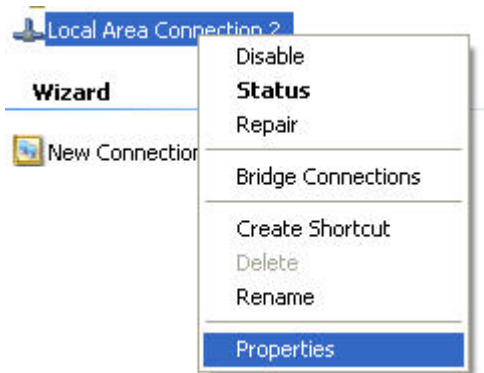

- b. On the Local Area Connection, right-click on **Properties**.



 **Note:** The PC in the example above has a second network card which is used to connect to the camera so it is using **Local Area Connection 2**.

- c. In the dialog, click on **Internet Protocol (TCP/IP)** and click the **Properties** button.

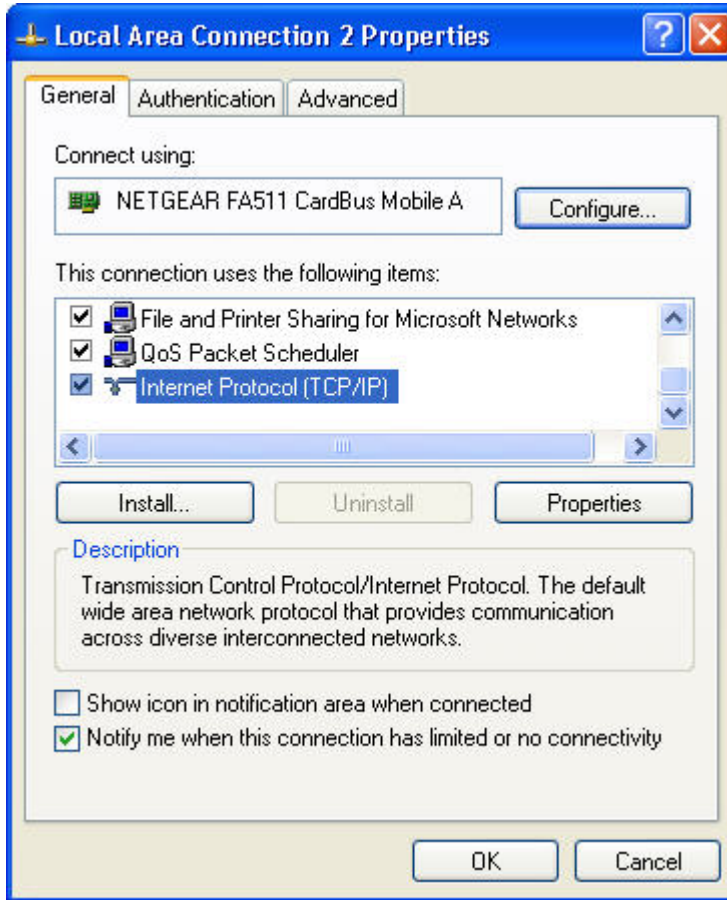

4. In the Internet **Protocol (TCP/IP) Properties** dialog, select **Use the following IP address** and make sure that the the IP address is 192.168.0.2, and the subnet mask is 255.255.255.0.

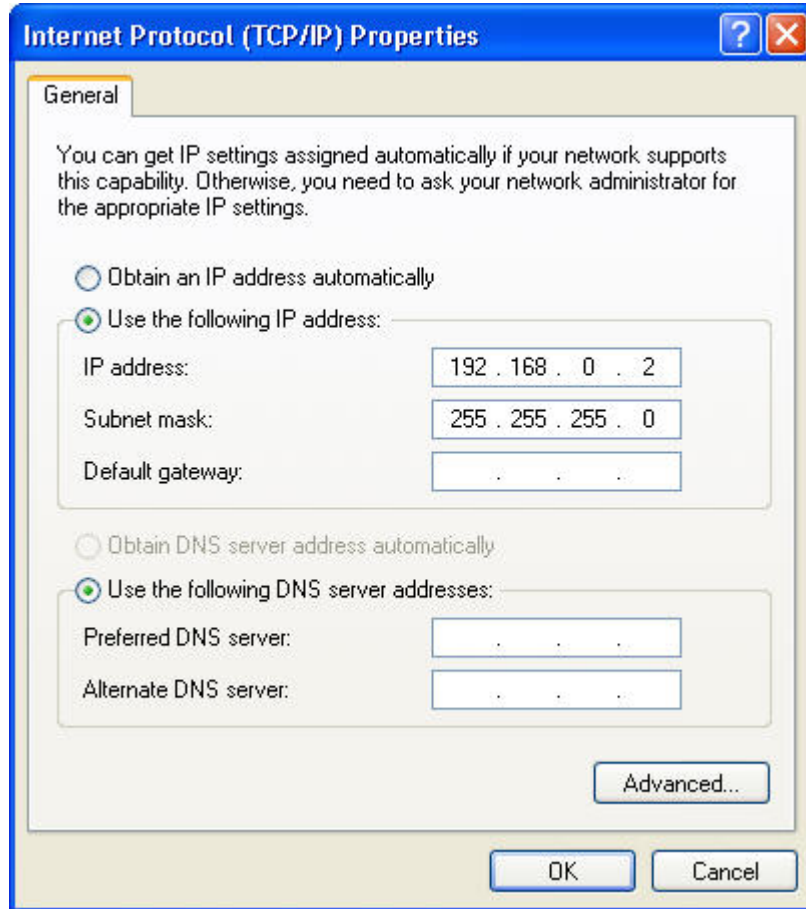

5. Start the software.
6. Upon initial startup, the software communication is not configured, and the following error message is displayed.

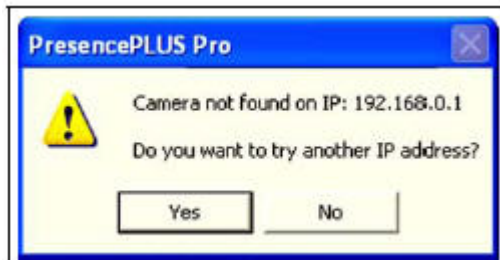

7. Click **Yes** to open the Communication screen.
8. Establish communications as follows:

#### **Ethernet Connection**

1. When the software is started for the first time, the IP address is "Localhost." Choose **Ethernet (RJ 45)**.
2. Change the IP address to 192.168.0.1 (default IP address of the sensor).
3. Click **OK**.



## 3.2 Typical Setup and Startup Sequence

The following subsections proceed through a typical Sensor setup and startup sequence

1. Connect and power up the hardware.
2. Start up the software.
3. Set up hardware parameters.
4. Build and run an inspection.

## 3.3 Startup and Troubleshooting

The following explains how to verify connections and start the *PresencePLUS* software.

1. Verify cable connections.
  - The sensor is connected to a PC with an Ethernet crossover cable or a serial cable.
  - The monitor, if used, is connected to the sensor's video port.
2. Thread the lens onto the sensor.
3. Verify electrical connections.
  - +V is connected to Pin 12, brown wire, 10-30V dc (24V dc  $\pm$  10% if a light is powered by the sensor).
  - -V is connected to Pin 11, blue wire (dc common).
  - The trigger device is connected to Pin 4 (pink wire, Trigger In).
  - Any additional connections are made as required.
4. Verify power. Ensure that the sensor is powered by 10-30V dc (24V dc  $\pm$  10% if a light is powered by the sensor).
5. Verify PC configuration.
  - **Ethernet connection:** IP address of PC is **192.168.0.2**.
  - **Serial connection:** A dial-up network has been established, and the network is a point-to-point protocol (PPP).
6. Power up the hardware and verify that the Error LED turns off.



- During powerup, all the sensor LEDs illuminate for 15 to 20 seconds.
- After the Red Error LED turns OFF, verify that the Green power LED is flashing.

#### 7. Launch the Software.

- Click Start > PresencePLUS to start the program.
- If the sensor has a different IP address than the default address (192.168.0.1), or if it is connected through a serial connection, the following error message will display:

**Sensor not found on specified IP address 192.168.0.1.**

**Do you want to try another IP address?**

- Click Yes to access the System Setup window.
- Click on the Sensor select tab, and change the connection setup as follows:

**Ethernet Connection --**

1. Select **Ethernet (RJ45)** in the drop-down menu.
2. Change the IP address to the address of the sensor to which the PC is connected.
3. Click **OK**.

**Serial Connection --**

1. Select **PC Serial** in the drop-down menu.
2. Click **OK**.

### 3.3.1 General Troubleshooting

The following table describes solutions to the most common problems in using the *PresencePLUS* software. For further assistance, contact Banner Engineering.

Problem	Cause/Solution
<ul style="list-style-type: none"> <li>• Green Power LED on sensor is not ON.</li> <li>• Interface cannot connect to the sensor.</li> <li>• No image on the monitor.</li> </ul>	Sensor not getting enough power. <ul style="list-style-type: none"> <li>• Check the connection to the power supply.</li> </ul>
<ul style="list-style-type: none"> <li>• No image on PC or monitor.</li> <li>• Green Ready LED on sensor is OFF.</li> <li>• The software seems to be working correctly, but the image is missing.</li> </ul>	Run display set to "None" <ul style="list-style-type: none"> <li>• Ensure that the sensor is receiving trigger signals.</li> </ul> Sensor not receiving triggers <ul style="list-style-type: none"> <li>• If the connections are secure, call a Banner Applications Engineer.</li> </ul>
<ul style="list-style-type: none"> <li>• Error message "Failed to capture a full-resolution image. Please try again."</li> <li>• Image is frozen on the PC and monitor.</li> <li>• Green Ready LED on sensor is OFF</li> </ul>	Software restart needed or there are loose connections. <ul style="list-style-type: none"> <li>• Restart the PresencePLUS software.</li> <li>• Check all connections.</li> <li>• If a software restart does not correct the problem and the connections are secure, call a Banner Applications Engineer.</li> </ul>

Problem	Cause/Solution
<ul style="list-style-type: none"> <li>• Error message "Failed to capture a full-resolution image. Please try again."</li> <li>• Image is frozen on PC, but image on monitor updates properly. Image is frozen on PC, but image on monitor updates properly.</li> <li>• Indicator lights on RJ-45 port are OFF.</li> </ul>	Ethernet connection lost. <ul style="list-style-type: none"> <li>• Reconnect the cable.</li> <li>• Check the cable for breaks, then power down and back up.</li> <li>• Replace the cable.</li> <li>• Attempt to close and reopen PresencePLUS software.</li> <li>• If none of these actions fix the problem, call a Banner Applications Engineer.</li> </ul>
<ul style="list-style-type: none"> <li>• Focus number does not update.</li> <li>• QuickStart fails.</li> <li>• Errors when saving inspections to the sensor.</li> </ul>	FTP communications is blocked. <ul style="list-style-type: none"> <li>• Disable TCP/IP Firewall software on the PC.</li> </ul>
<ul style="list-style-type: none"> <li>• Error code is displayed on PC.</li> </ul>	<ul style="list-style-type: none"> <li>• A list of error codes and potential causes and solutions are available in the main help.</li> </ul>

### 3.4 Setting Up Hardware Parameters

If the Sensor is being run for the first time, or if changes have been made to the hardware, then you may need to set or modify hardware parameters.

1. Click on **System** in the Main Menu toolbar.
2. Configure the Trigger parameter according to the trigger device being used. For example, if using the QS18V6ND as the trigger device, then select NPN.
3. Configure the six discrete inputs/outputs.
4. If the controller triggers a strobe light source, set the strobe trigger options.
5. If using the product select, configure the product select and product change lines to be NPN or PNP as required.
6. Click on **Setup** in the Main Menu toolbar, select **Trigger** tab, and configure the remaining parameters:
  - Polarity
  - Minimum Trigger Width
  - Trigger delay
  - Trigger Divide

### 3.5 Building an Inspection

The automatic screen sequence starts with the Setup screen, which results from the first button (Setup) in the Main Menu toolbar. Subsequent screens are shown below in the Main Menu toolbar layout.

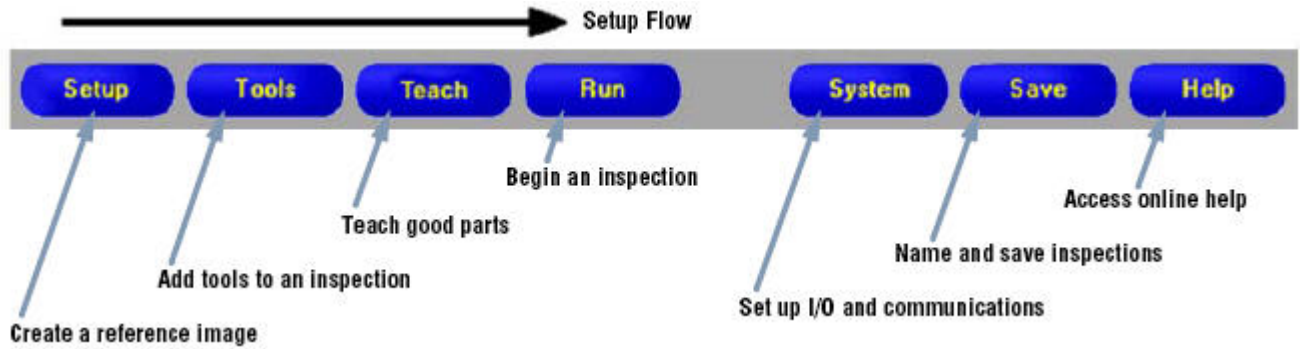

### 1. Setup screen:

- Set up the camera, lens, and lighting.
- Choose trigger option **Continuous** for a live image.
- Click **Auto-exposure** to adjust the image brightness.
- Focus the lens by turning the lens focusing ring until the focus value is maximized.
- When the desired image is shown, click **Next** to proceed to the Tools screen.

### 2. Tools screen:

- Add Location tool(s) to find the target to adjust the Regions of Interest (ROI) for translational and rotational changes.
- Required:** Add Vision tool(s) to inspect the part.
- Add Measure tools(s) to create distance measurements from points found.
- Required:** Add Test tool(s) to set the Pass/Fail criteria (Vision and Measure tools are inputs to the Test tool).
- Click **Quick Teach** to automatically set all the selected parameters in the Test tool and to proceed to the Run screen, or click **Next** to proceed to the Teach screen and to teach a sample set of good products.

 **Note:** To keep specific, user-defined parameters in a Test tool, skip Teach and go directly to Run.

### 3. Teach screen:

The Teach screen automatically configures the parameters chosen in the Tools screen.

- Choose the sample size.
- Click **Start**.
- Trigger the controller with the external trigger device.
- Click **Stop**.

 **Note:** Before entering Run, save inspection file to one of the memory locations on the controller.

- Click **Next** to proceed to the Run screen.

 **Note:** Save a backup copy of the inspection to the host PC.

### 4. Run screen:

Select an inspection to run, and review the results of the inspection.

- To select an inspection (in the **Select** tab), enable **Software Override**, and select the inspection file from the list of stored inspections on the camera.
- An alternate method is to use **Hardware input** to select an inspection via discrete inputs to the controller.

5. **Begin inspection:**

To begin inspecting, click the **Start** button in the Run screen.

---

# Setup

## 4.1 Setup Screen

The Vision sensor has two modes: running and idle. If the sensor is idle when you start up the *PresencePLUS* software while your PC is connected, the software starts in the Setup screen. If the sensor is running, then the software starts in the Run screen.

## 4.2 Capturing a Reference Image

The reference image is used as a template for developing an inspection. The Vision tools use this image to acquire the critical information needed for the inspection.

Acquiring a quality image is crucial for a successful inspection. A quality image shows a measurable and repeatable difference between good products (which pass inspection) and bad products (which fail inspection). Most commonly, what determines the quality of the image is the illumination.

## 4.3 Focus Tab

The Focus tab on the Setup screen is used to:

- [Reference Image Source](#)[4.3.1 Reference Image Source](#) on page 30
- [Focus Value](#)[4.3.2 Focus Value](#) on page 31
- [Auto Exposure](#)[4.3.3 Auto Exposure](#) on page 31

**Focus tab**





### 4.3.1 Reference Image Source

Before capturing an image, you need to determine what will trigger the Sensor to capture and image.



The Sensor can be triggered to capture an image in one of the following ways.

Trigger Option	Description
<b>Continuous</b>	The sensor will update continuously in Setup mode.
<b>External</b>	Images are acquired only in response to a signal from an external source as configured on the Trigger tab. Choose <b>External</b> if the part will be moving during the inspection to capture an image with the same conditions as the inspection conditions.
<b>Manual</b>	Images are acquired only when the <b>Trigger</b> button is clicked. The <b>Trigger</b> button is grayed out when any trigger option other than Manual is selected.
<b>From Disk</b>	If you check this option, the a <b>Trigger</b> button allows you to browse for an image to load from disk.

 **Note:** The trigger options described above are used only in the Setup routine. Note, though, that Run mode does require an external trigger.

### 4.3.2 Focus Value

The Focus value on the Focus tab is a number between 1 and 255.

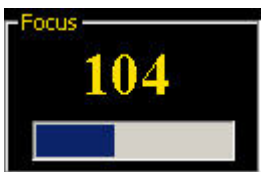
	<p>To focus the lens, place the target object so that the area to be focused appears on the center of the displayed image. You can use the image on the PC to determine when the image is sharp enough, or you can use this Focus value as a guide. Turn the focus ring on the lens until the Focus value is at the highest possible number between 1 and 255. Note there is no optimal value for this number, but it can be used as a guide if setting up more than one camera focused on the same target.</p>
--	---

### 4.3.3 Auto Exposure

When you click Start in Auto Exposure, the exposure time and gain are optimized for the current inspection and the Status field provides feedback.

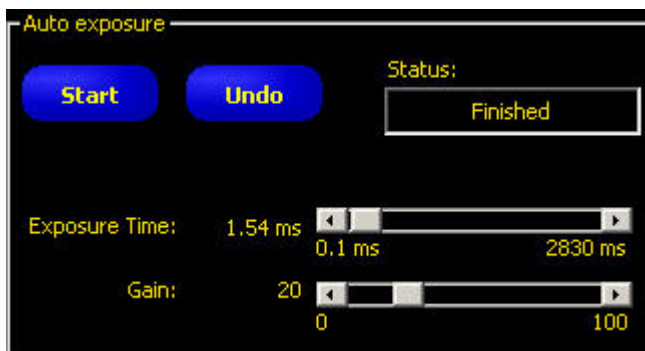

Field	Description
<b>Status</b>	The following are status possibilities: <ul style="list-style-type: none"> <li>• <b>Not running</b> -- Auto exposure has not been activated since entering this screen.</li> </ul>

Field	Description
	<ul style="list-style-type: none"> <li>• <b>Running</b> -- Auto exposure is currently running.</li> <li>• <b>Finished</b> -- Auto exposure has run and is complete.</li> <li>• <b>Image too dark</b> -- Auto exposure could not brighten the image enough. Add more light to the inspection, or increase the exposure manually.</li> <li>• <b>Image too bright</b> -- Auto exposure could not darken the image enough. Remove light to the inspection, or decrease the exposure manually.</li> </ul>
<b>Exposure Time</b>	Exposure time is the amount of time the camera allows light to energize the image chip. Increasing the exposure time (that is, moving the slider to the right) allows more light to energize the image chip, which brightens the image.
<b>Gain</b>	<p>Gain is an electronic boost to the image signal. Increasing gain (that is, moving the slider to the right) increases image brightness without increasing exposure time.</p> <p> <b>Note:</b> Gain brightens both the light pixels and dark pixels. High gain values will make the image appear grainy.</p>

## 4.4 Trigger Tab

An external trigger is used to tell the Sensor when to capture an image. You can modify the validity and timing of the trigger by setting the parameters on the Trigger tab.

 **Note:** Parameters set in the Trigger tab are stored in the inspection file and can be different for each inspection.

**Trigger tab**





#### 4.4.1 Trigger Settings

Field	Description
<b>Trigger Divide (range: 1-10,000 triggers)</b>	Sets the sequence of valid triggers. If set to 1, an image is captured in response to every valid trigger; if set to 2, and image is captured in response to every second valid trigger, and so on.
<b>Trigger Delay (range: 0-8,000 ms)</b>	Fixed time (ms) from the instant the Sensor receives a valid trigger to the instant the Sensor captures the image.
<b>Minimum Trigger Width (range: 1-8,000 ms)</b>	Eliminates unwanted triggers by accepting triggers only if they are above a specified duration.
<b>Polarity</b>	Choose Leading Edge to capture images at the leading edge of a trigger signal. Choose Trailing Edge to capture images at the trailing edge of the trigger signal.

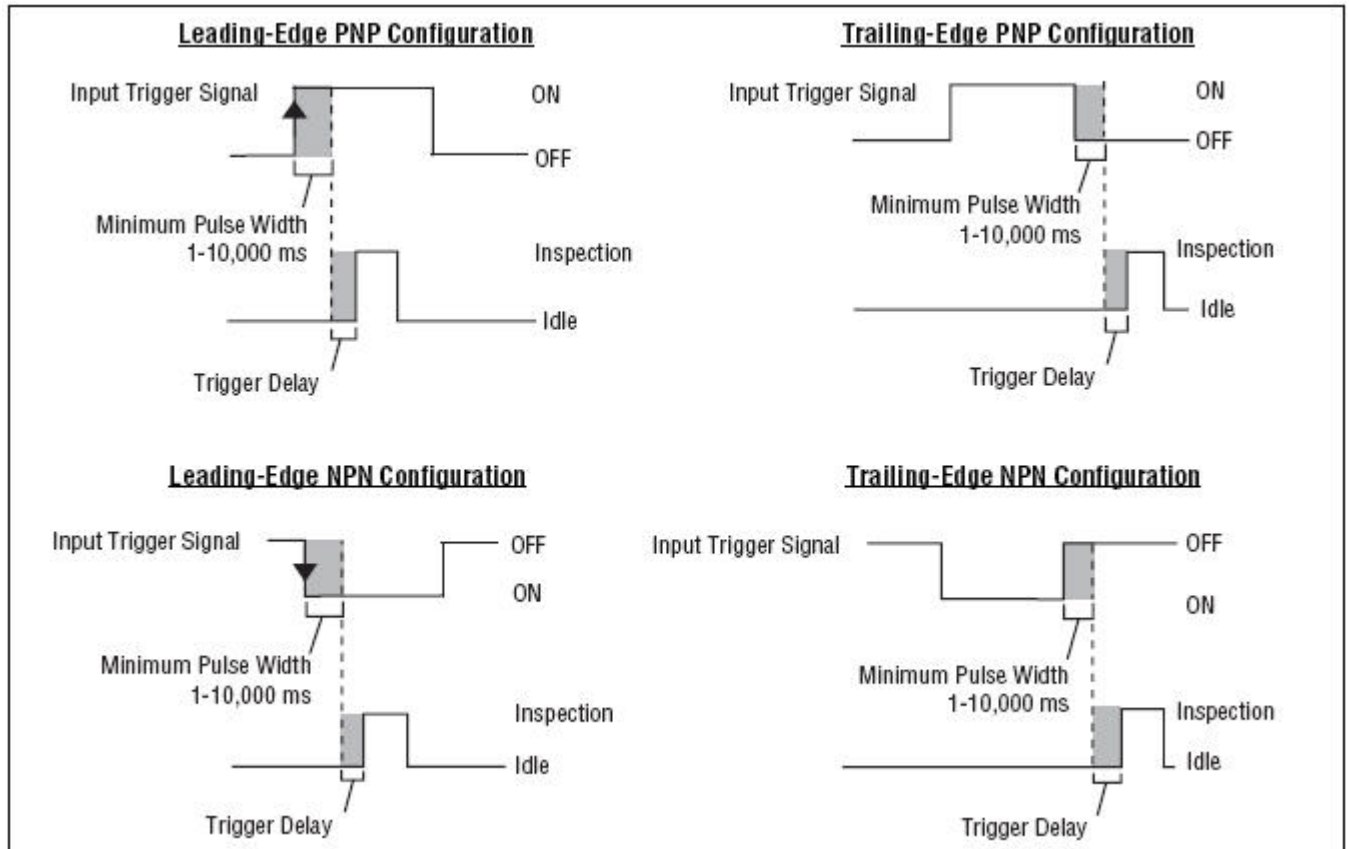

## 4.4.2 Resolution

Increases or decreases the resolution on the displayed image. A lower resolution will have a faster PC update. The resolution does not change the inspection. Resolution options are 1:1, 4:1, 16:1, and 64:1.



## 4.5 Advanced Tab

The Advanced tab on the Setup screen allows you to adjust the field of view (FOV). The FOV is the image area at the focal plane of a camera.

You can use the maximum FOV or adjust the FOV to improve performance. The FOV dimensions are shown in the Advanced tab.

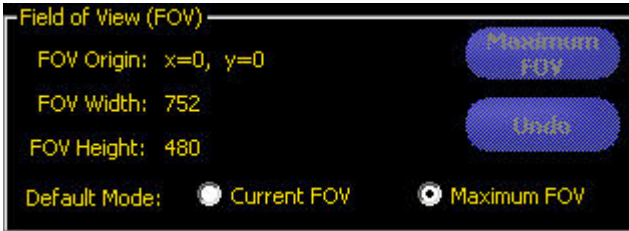

### Default Mode

The Default Mode determines whether to use the Current FOV or Maximum FOV by default.

### Maximum and adjusted FOV

The FOV is denoted by the green box surrounding the image in the Setup screen. The maximum FOV is shown below.



To improve performance, reduce the size of the FOV either vertically, horizontally, or both, as shown below.



# Tools Screen

## 5.1 Overview

Using the Tools screen, the user establishes the inspections that the Sensor will execute. Three sources of inspections are available:

1. **Building an inspection from scratch** is the typical method of establishing an inspection. The Tools screen is designed to aid the user in building an inspection. A typical inspection consists of Location Tools, followed by Vision Tools, Analysis Tools, and finally (if required) the Communication Tool. The Tools screen, shown below, supports this inspection organization.
2. **Existing inspections can be obtained from the sensor** (with or without the reference image) for execution or modification. This method is very useful if the user has an existing inspection on the controller and needs to make modifications to establish a new inspection.
3. Existing inspections also can be obtained from host resources using the Library. In this case, the sources of the inspections are the host's hard drive or network resources. This method provides access to an unlimited number of existing inspections (with or without the reference image) for execution or modification.

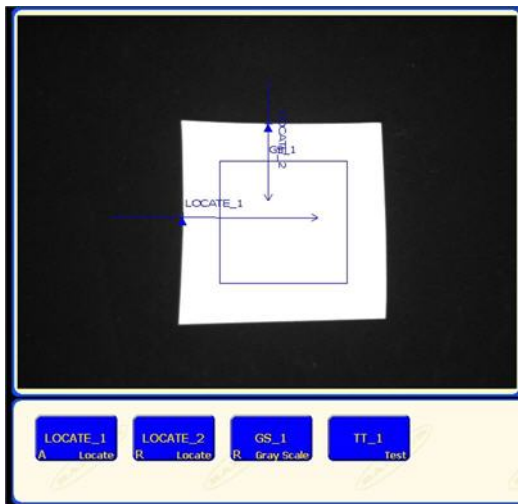

## 5.2 Typical Build/Modify Procedure

### 5.2.1 Choosing a Tool

To choose the right tools for an inspection, consider the tool's parameters and result options:

- Parameters are selected inputs for each tool (for example, relative threshold).
- Results are the information returned from the tool after it has executed.

Some tools perform evaluations, while others provide positional data for the tools that follow. Test tools evaluate, combine, or compare the results of other tools and determine a Pass-or-Fail judgment.

 **Note:** Test tool must be chosen to evaluate the results of each tool or set of tools.

### 5.2.2 Adding a Tool

The following steps provide an overview for setting up tools in an inspection. Steps not available for some of the Location or Analysis tools are noted.

1. Click the button of the tool to be added to the inspection.
2. Rename the tool.
3. Draw the ROI (not available for Analysis tools).
4. Set Input options to indicate the expected results (not available for the Test tool).
5. Add a Test tool.
6. Configure the Test tool inputs and, if desired, configure the desired results.
7. Set the judgment tolerances in one of three ways:
  - Use Quick Teach.
  - Use Teach.
  - Manually set the judgment tolerances.

### 5.2.3 Adding a Test Tool

The following steps provide an overview for adding a Test tool to an inspection.

1. Add a Test tool.
2. Configure the Test tool inputs.
3. Set the judgment tolerances.

### 5.2.4 Renaming Tools

The default name of each tool can be edited or replaced (examples: GS\_1, TT\_2). Each name must be unique.

To edit the tool name, click on the Name field (double-click to select the entire name), and type to change or replace the name.

- Enter up to 49 characters; only alphanumeric characters and underscores are valid.

- The button in the Navigation/Results window that appears will show the first nine characters after exiting the tool.

### 5.2.5 Removing a Tool

To remove a tool:

1. Choose the tool to be removed in the Navigation/Results window.
2. Click the Delete button in the lower-left corner of the screen.

## 5.3 Quick Teach

Quick Teach provides the fastest and easiest method of establishing an inspection. Quick Teach will use the reference image to establish Pass/Fail parameters of the Test tools.

Quick Teach does the following:

- Executes the inspection on the reference image.
- “Learns” the results of the Vision tools.
- Applies the applicable tolerances (user-determined, but default is 10%) to the selected parameters in the Test tool (these parameters determine the Pass/Fail criteria for each Test tool within the inspection).

 **Note:** Quick Teach discards any manually-entered values in the Test tool. Manually-entered values must be entered after Quick Teach has been performed, or they will be lost.

Click Quick Teach to:

- Run all the tools.
- Calculate the measurements.
- Add a percentage of tolerance around taught values.
- Save the inspection to the controller.
- Go to Run.

## 5.4 Load Tab

The Load provides a way to load a saved inspection and a reference image.

**Load Tab**



The screenshot shows the 'Tools' screen with the 'Load' tab selected. The interface includes a 'Load from:' dropdown menu set to 'Sensor'. Below this is a table with columns 'Number' and 'Name'. A checkbox labeled 'Load reference image' is checked. There are input fields for 'Inspection Number:', 'Inspection Name:', and 'Load file type:' (set to '\*.ins'). At the bottom are 'Load' and 'Delete' buttons.

Number	Name
--------	------

### 5.4.1 Flexible Inspection Loading

Release 2009R1B introduces a more flexible inspection loading capability that allows most inspections created by any *PresencePLUS* vision sensor to be loaded through the *PresencePLUS* software even if connected to a different type of *PresencePLUS* vision sensor. This means that you can now load, for example, an inspection created by an OMNI 1.3 into *PresencePLUS* software connected to a standard OMNI. Prior to Release 2009R1B, inspections could only be loaded into *PresencePLUS* software that was connected to the same type of *PresencePLUS* vision sensor that had created the inspection. In other words, a ProII camera could only load inspections created by another ProII camera, and an OMNI could only load an inspection saved from another OMNI, etc.

**Note:** The one limitation that still exists occurs when trying to load an inspection that uses a tool that is unavailable (or unlicensed) for the currently connected sensor (for example, attempting to load to an inspection that uses a Geometric Count tool to a *PresencePLUS* AREA sensor will not work because the Geometric Count tool is not supported on the AREA sensor).



Inspection Source	Inspection Destination	Result	Possible Inspection Modifications
Color sensor (for example, a Color OMNI)	Standard grayscale sensor (for example, a standard OMNI)	A dialog indicates that the image color has changed and the inspection loads	None required
Grayscale sensor (for example, a standard OMNI)	Color sensor (for example, a Color OMNI)	A dialog indicates that the image color has changed and the inspection loads	None required
High Resolution (1.3) sensor (for example, an AREA 1.3 sensor )	Standard VGA sensor (for example, a standard AREA sensor)	A dialog indicates that the image/FOV has been adjusted and the image loads the image into the upper-left of the FOV. Note that the image may be cropped at the right and/or bottom and ROIs may be outside the image area	Reposition image, adjust ROIs and tools in the FOV, and possibly acquire a new reference image
Standard VGA sensor (for example, a standard AREA sensor)	High Resolution (1.3) sensor (for example, an AREA 1.3 sensor)	A dialog indicates that the FOV has been adjusted and the inspection loads with the image centered in the FOV	Possibly acquire a new reference image
Sensor with 6 I/O (for example, a ProII)	Sensor with 4 I/O (for example, an OMNI)	A dialog indicates that the inspection uses I/Os not available on the sensor and the inspection loads	Adjust I/O as appropriate
Sensor that supports a larger maximum trigger delay, trigger width, NTSC fail/hold time, or exposure time (for example, a ProII maximum trigger delay set to 10000 ms)	Sensor that supports a smaller maximum trigger delay, trigger width, NTSC fail/hold time, or exposure time (for example, a standard OMNI maximum trigger delay set to 8000 ms)	A dialog indicates that the timing was adjusted and the inspection loads with the timing(s) adjusted to the maximum time allowed on that sensor	Retest and modify timings as appropriate, and possibly acquire a new reference image

### 5.4.2 Inspection Storage Capacity

The INS file format allows for the storage of inspection files onboard every sensor. The table below shows the storage capacity for the various Vision sensors. Stored inspections can be modified, run, or deleted on the sensor.

Sensor Type	INS Storage Memory	Number of INS Files	Number of INS files without Reference Images*
Pro II	64MB	188	999

Sensor Type	INS Storage Memory	Number of INS Files	Number of INS files without Reference Images*
Pro II Color	64MB	160	999
Area/GEO/Edge	8MB	150	500+
OMNI	32MB	85	999
OMNI Color	32MB	72	999
Pro II 1.3	64MB	44	999
OMNI 1.3	64MB	44	999
BCR		8	400+
GEO/Edge/Area/BCR 1.3	32	20	999

\*Not saving a reference image with the inspection frees up a lot of room onboard the sensor. However, inspections that include any of the following tools require a reference image to be saved:

- Geometric Find
- Geometric Count
- Pattern Find
- Pattern Count
- Color Match
- Color BLOB

### 5.4.3 Opening an Inspection from the Sensor or a Library

Inspections can be stored on the sensor or to a library of inspections stored on a PC or network drive. To select and open an inspection from the sensor or a library:

1. Click the Load tab.
2. From the **Load from** drop-down list, select the Sensor or a location on a PC or Network.
3. Select the desired inspection.
4. Click the Load button.

The tools from the selected inspection populate the Navigation/Results window. At this point, all tools in the inspection can be modified. If new tools are to be added, simply select the tool in the Tool screen. If tools are to be deleted, select the tool and click the Delete icon.

 **Note:** If you want to see the the image stored with the inspection, check the **Load reference image** box.

### Tools

Location Vision Analysis **Load**

Load from:

Number	Name
1	new.ins
2	new1.ins

Load reference image

Inspection Number:

Inspection Name:

Load file type:



---

# System Setup Window Overview

To access the System Setup window, click the **System** button in the Main Menu toolbar on the application window.

To clear changes, click **Cancel**. To save changes and exit the System Setup window, click **OK**.

To exit the System Setup window without changes, click the **X** in the upper-right corner of the window.

 **Note:** To make changes to the sensor selections, an inspection must not be running. To stop a running inspection, click the **Stop** button in the Run tab. To save changes, click **OK** before exiting the tab or closing the window.

The System Setup Window includes the following tabs:

- [Sensor Select Tab](#)[6.1 Sensor Select Tab](#) on page 46
- [Communication Tab](#)[6.2 Communication Tab](#) on page 51
- [Input/Output Tab](#)
- [Strobe Tab](#)[6.4 Strobe Tab](#) on page 84
- [Units Tab](#)[6.5 Units Tab](#) on page 85
- [Reset Tab](#)[6.6 Reset Tab](#) on page 86
- [Start-Up Inspection Tab](#)[6.7 Start-Up Inspection Tab](#) on page 87
- [NTSC Tab](#)[6.8 NTSC Tab](#) on page 89
- [Language Tab](#)[6.9 Language Tab](#) on page 90
- [Tools Configuration](#)[6.10 Tools Configuration](#) on page 91

**System Setup Window**

**P4 System Setup Window**

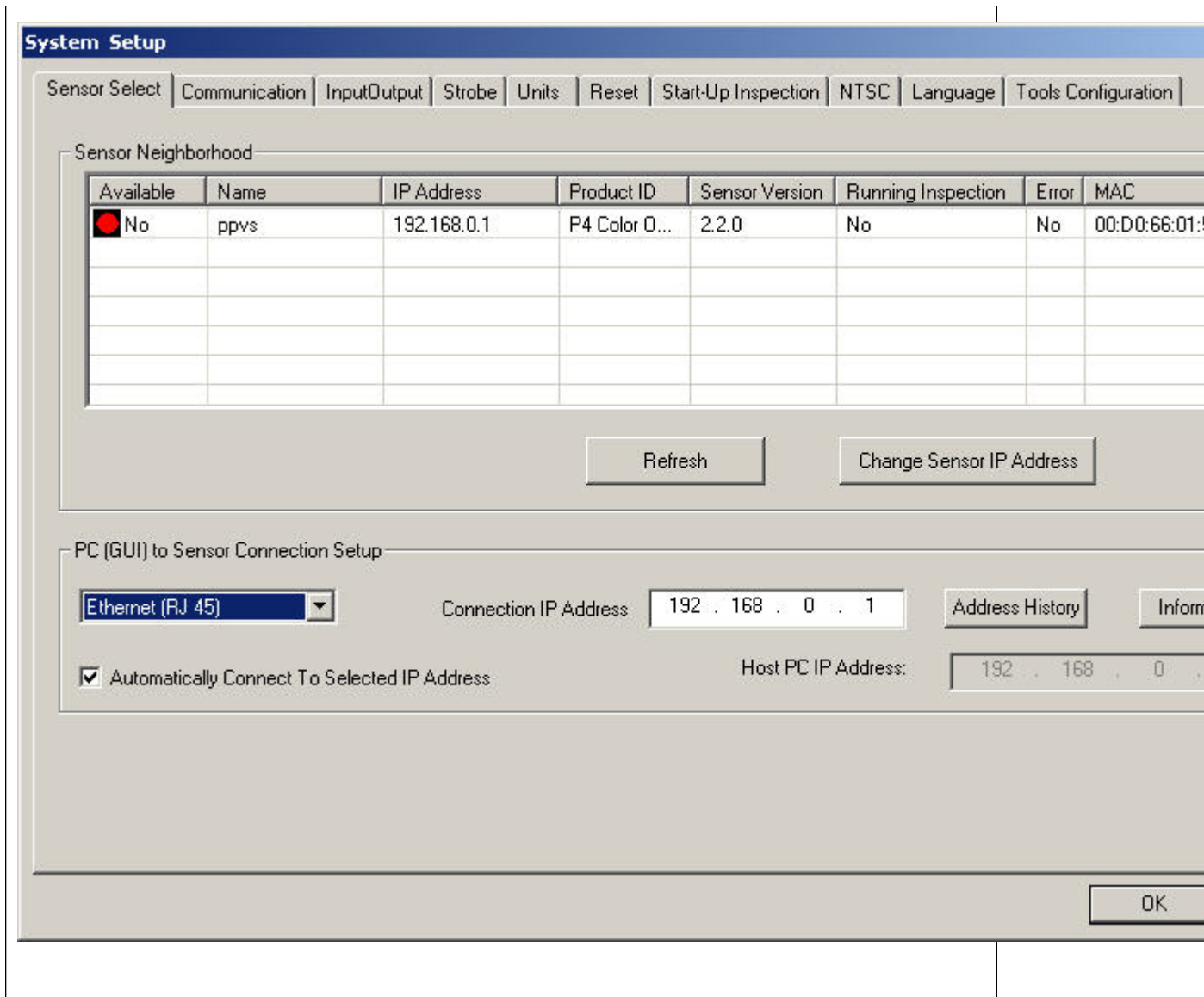

## 6.1 Sensor Select Tab

Use the Sensor Select tab to establish the Sensor connection with the PC.

-  **Note:** An option box to open the Sensor Select tab is automatically displayed if the Sensor either is not connected or is connected but with the wrong IP Address selected.

### Sensor Neighborhood Fields

The Sensor Neighborhood will list sensors in your environment. The following describes the fields in the Sensor Neighborhood.

Field	Description
<b>Available</b>	If the Icon is green (Yes), the sensor is available; if yellow, a connection can't be established for some reason; if red (No), the sensor is not available.   <b>Note:</b> The sensor to which you are currently connected will show up as unavailable (red icon).
<b>Name</b>	The name of the sensor.
<b>IP Address</b>	The IP address assigned to the sensor.
<b>Product ID</b>	The sensor model and type.
<b>Sensor Version</b>	The sensor version.
<b>Running Inspection</b>	Indicates whether the sensor is running or not.
<b>Error</b>	Indicates whether there is an error condition associated with the sensor.
<b>MAC</b>	The MAC address of the sensor.

### PC (GUI) to Sensor Connection Setup

This selection is used to configure the communication link between the GUI (Graphical User Interface) and the sensor. There are two possible selections, Ethernet (RJ45) and Serial:

- **Ethernet (RJ45)**

This selection will configure the GUI to communicate with the sensor using the Ethernet (RJ45) connection. To establish communication you must enter the IP address of the sensor you would like to communicate with into the "Connection IP Address" edit box or select the desired Sensor from the Sensor Neighborhood results. Then, click on the "OK" button to connect.

- **Serial**

This selection will configure the GUI to communicate with a sensor via the Serial connection. To establish communication you must first start Dial-Up Networking (DUN) on the PC. Then, click on the "OK" button to connect.

**Sensor Select Tab**

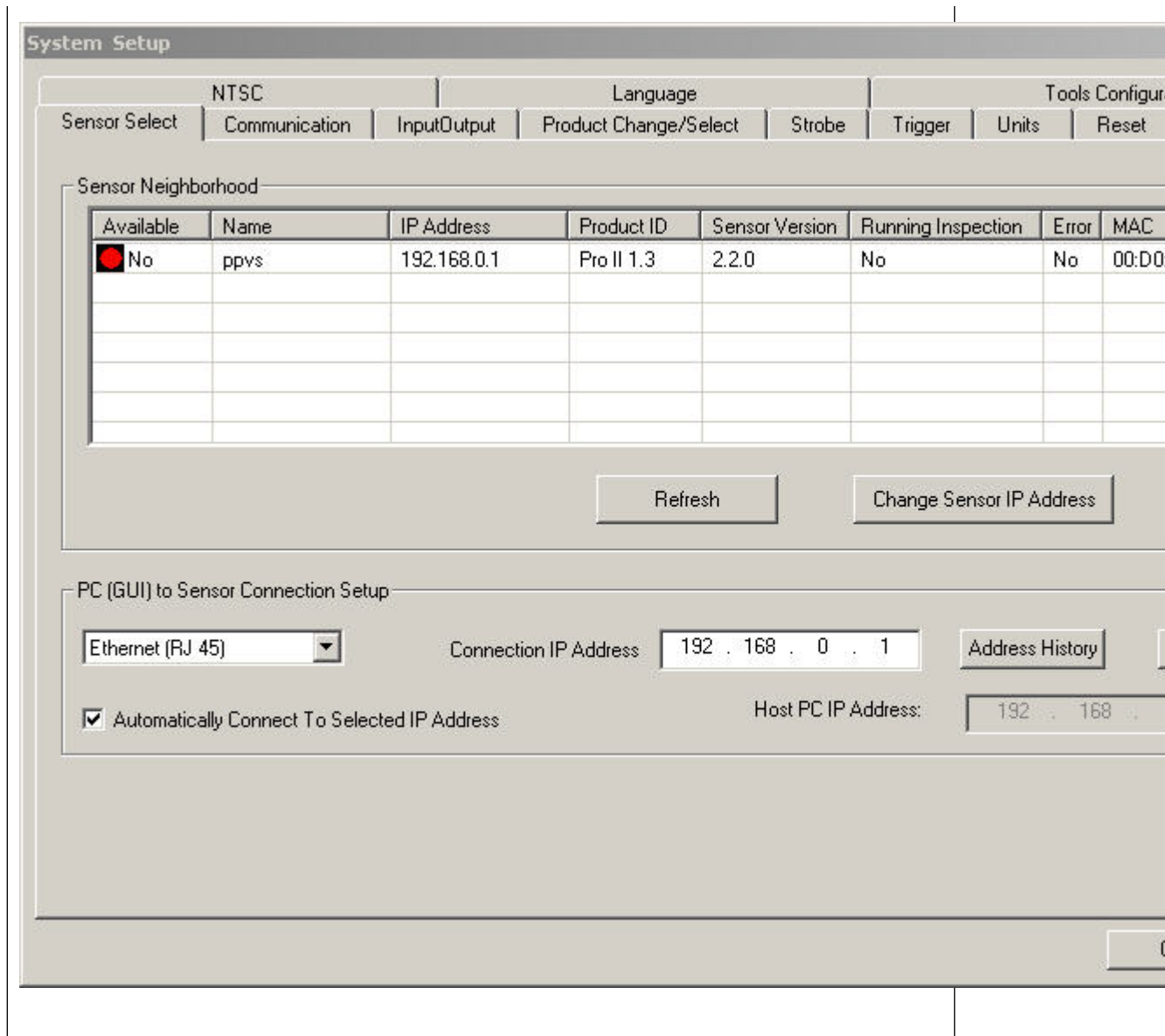

### 6.1.1 Change Sensor IP Address

To change a sensor's IP address:

1. Select the sensor in the **Sensor Neighborhood**
2. Click the **Change Sensor IP Address** button.



Select Ethernet Adapter

Please Select Ethernet Adapter Connected to Same Subnet as Sensor.

Adapter Description: ADMtek AN985 10/100Mbps Fast Ethernet Adapte

IP Address: 192 . 168 . 0 . 2

Subnet Mask: 255 . 255 . 255 . 0

Default Gateway: 0 . 0 . 0 . 0

< Back    Next >    Cancel

3. Click **Next**
4. Enter an appropriate sensor name in the **New Sensor Name** field.

Set Sensor IP Address

Please Enter New Values (Entries Initialized With Suggested Values).

New Sensor Name: ppvs

New IP Address: 192 . 168 . 0 . 1

New Subnet Mask: 255 . 255 . 255 . 0

New Gateway: 0 . 0 . 0 . 0

Sensor MAC Address: 00:D0:66:01:55:C1

Host PC IP Address: 192.168.0.2

< Back    Finish    Cancel

5. Click **Finish**.

## 6.1.2 PC (GUI) to Sensor Connection Setup

Use this field to select whether the Sensor will communicate via the Ethernet port or a serial connection.

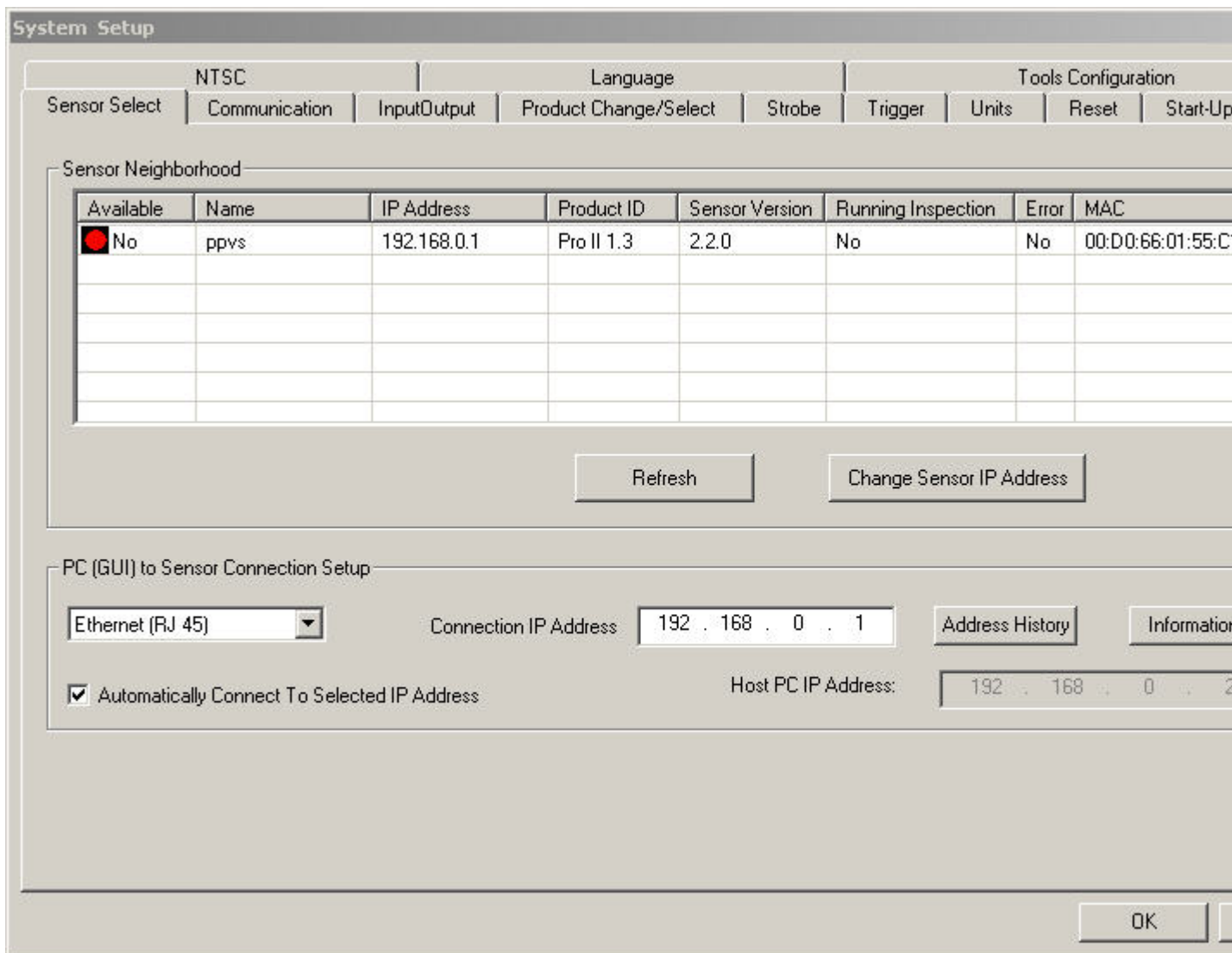

- If you select **Ethernet (RJ 45)**, the Connection IP Address shows the IP address for which the software is looking. Initially, the IP address should be 192.168.0.1, the default IP address of the sensor.
- If you select **Serial**, the IP address is not applicable.

### 6.1.3 IP Address History

Use this button to view previous IP Addresses and Subnet Masks.

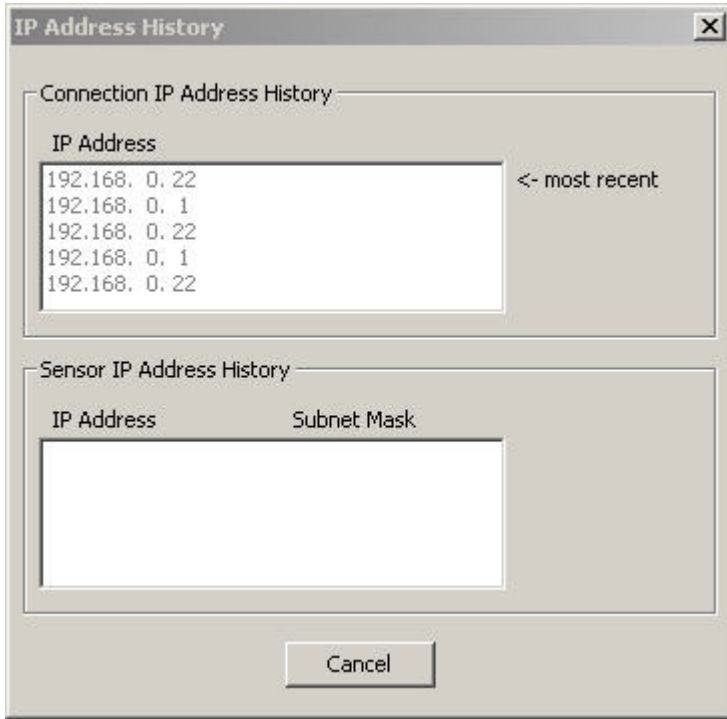

## 6.2 Communication Tab

The Communication tab is used to configure:

- General Communication Setup
- Remote Command Configuration (RCC)



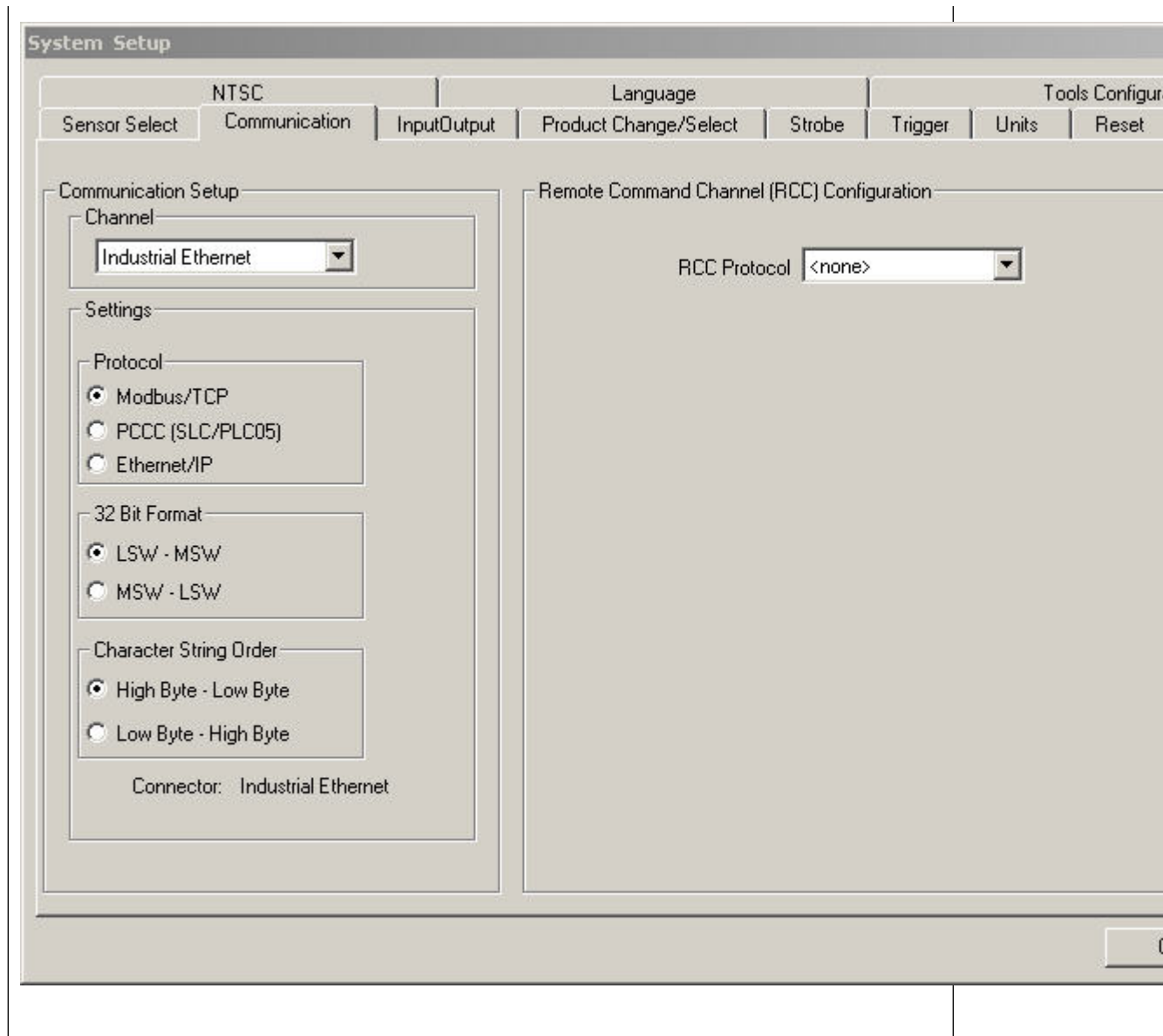

## 6.2.1 Communication Setup

Banner Vision sensors support the following communication options:

- Ethernet Sockets 1-10
- Serial 1
- Industrial Ethernet

### Ethernet Connection

In order to establish an Ethernet connection, the external device must be directed to the correct IP address and the correct TCP port. In TCP/IP protocol, a TCP port number is used with the IP address to identify a specific path or socket. The sensor has sockets 1 to 10, and can send out unique sets of data to 10 different devices.

Valid user TCP/IP port numbers are in the range of 1024 through 65535. The PresencePLUS GUI provides automatic notification if you attempt to use a reserved port.

To view an Ethernet connection:

1. Click on the System button in the Main Menu toolbar to bring up the System Setup window.
2. Click on the **Communication** tab.

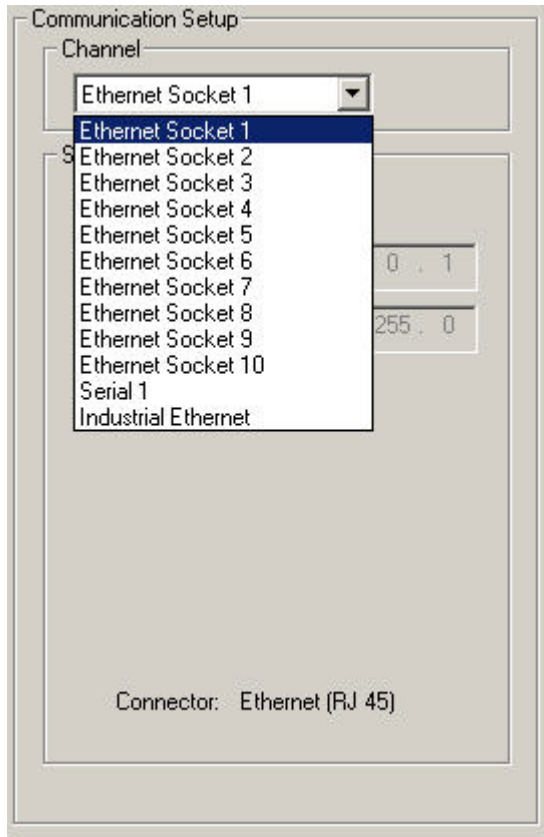

3. Choose a connection from the fixed Connection drop-down list of the **Communication Tool Setup** field.

Each Ethernet socket has a unique TCP port number as shown below

 **Note:** The following addresses are defaults.

Socket	Default IP Address	Port
1	192.168.0.1	20000
2	192.168.0.1	20001
3	192.168.0.1	20002
4	192.168.0.1	20003
5	192.168.0.1	20004
6	192.168.0.1	20005

Socket	Default IP Address	Port
7	192.168.0.1	20006
8	192.168.0.1	20007
9	192.168.0.1	20008
10	192.168.0.1	20009

### Serial Connection

The sensor has a single serial connection that you can configure, Serial 1:

- Serial 1 is the DB-9 connector.

 **Note:** The Pro has 2 serial connections. Serial 2 in the dropdown list is to support those sensors.

The sensor has one serial connection that can be configured: Serial 1 is pins 1, 9, and 10. Set up the serial communication options to match the receiving device. The following table shows the configuration options:

Attribute	Default Setting
Baud Rate	115200
Data Bits	8
Parity	None
Stop Bit	1
Flow Control	None

To setup a serial connection:

1. Click on the **System** button in the Main Menu toolbar to bring up the System Setup window.
2. Click on the **Communication** tab.
3. Choose Serial 1 from the Connection drop-down list of the **Communication Tool Setup** field.

Communication Setup

Channel: Serial 1

Settings:

Baud Rate: 115200

Data Bits: 8

Parity: None

Stop Bits: 1

Flow Control: None

Connector: Serial

 **Note:**

Because there is no flow control for the serial connections, the sensor will not detect or log a lost or broken connection

## Industrial Ethernet

### Protocol

Protocol selects which Industrial Ethernet protocol is being used. This changes the string format and the word/register values reported in the PLC Map.

### 32 bit Format

32 bit Format determines how 32 bit integers and floating point values are stored in sequential 16 bit registers (words) - least significant word first (LSW-MSW) or most significant word first (MSW-LSW).

### Character String Order

For Modbus/TCP and PCCC protocols, characters in the string can be packed into registers according to either the Standard String format or the ControlLogix Format1:

- Standard String Format is used when the Character String Order option is set to “High Byte – Low Byte” selection.

**Please note that the length of the string is stored in one 16-bit register:**



- ControlLogix packing format is used to store characters into registers when the Character String Order option is set to “Low Byte – High Byte” selection.

**Please note that in this particular case, the length of the string is still stored in one 16-bit register, and only the order of characters in each 16-bit register follows the ControlLogix format:**

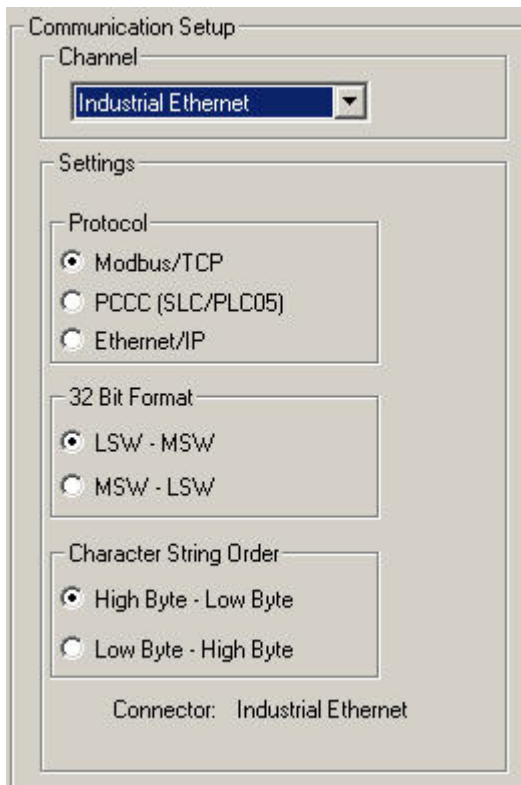
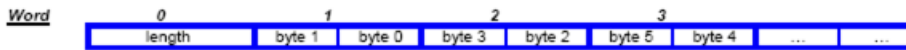

## 6.2.2 Remote Command Channel Configuration

This section describes the commands that are supported to communicate with a Vision sensor. All commands are case-insensitive

### Remote Command Set

All RCC commands are case-insensitive. Valid characters for commands are 7-bit ASCII alphabetic or numeric characters (A-Z, a-z, 0-9), dash (-) and underscore (\_).

All commands have the following structure:

*ACTION OBJECT\_IDENTIFIER QUALIFIER(S)*



*ACTION* is an operation the user intends to perform on the *OBJECT\_IDENTIFIER*. There are three possible actions available:

- **GET** — used to retrieve information associated with the named object. This information can be a Boolean value, and unsigned or signed number, a string or, for complex objects like the Communications tool, a field-delimited record that includes other data types.
- **SET** — used to assign a value to a named object.
- **EXEC** — used to execute a pre-defined functional object or activity in the sensor. Activities may take object identifiers as parameter qualifiers.

The table below identifies objects that are supported in the current RCC release, their identifiers, and the corresponding actions that they will support. Items highlighted in bold are command keywords. Flag objects are appended with the **FLG** suffix, status objects are appended with the **STS** suffix, and counters are appended with the **CNT** suffix.

<b>System Object, Component, or Activity</b>	<b>Object or Activity Identifier</b>	<b>Support Actions</b>	<b>Required Qualifiers</b>	<b>Optional Qualifiers</b>	<b>Comments</b>
Trigger	<b>TRIGGER</b>	<b>EXEC</b>	None	Timeout (msec) or <b>NOWAIT</b>	If no qualifiers are specified, a 30 second timeout is used.
Product Change	<b>PRODCHANGE</b>	<b>EXEC</b>	Numeric Inspection ID	Timeout (msec) or <b>NOWAIT</b>	By default, a 30 second timeout is used.
Counter or Flag Reset	<b>RESET</b>	<b>EXEC</b>	<b>SYSERRFLG</b> or <b>PASSFAILCNT</b> or <b>MISSTRIGCNT</b>	None	Reset either the System Error Flag, Pass and Fail counters, or Missing Trigger count.
Remote Teach	<b>RTEACH</b>	<b>EXEC</b>	None	<b>TRIGGER</b> or <b>TRIGGER NOWAIT</b> or <b>TRIGGER</b> Timeout (msec)	Enables remote teach. If no qualifiers are specified, remote teach will occur on the next trigger. If <b>TRIGGER</b> qualifier is specified, remote teach will occur

System Object, Component, or Activity	Object or Activity Identifier	Support Actions	Required Qualifiers	Optional Qualifiers	Comments
					immediately, and the command will block until a default 30-second timeout expires. If TRIGGER NOWAIT is specified, remote teach will occur immediately, and the command will return right away. If a timeout value is specified, the command will block until the specified timeout expires.
Online Status	<b>ONLINESTS</b>	<b>GET</b>	None	None	Retrieve the sensor online status.
Ready State	<b>READYFLG</b>	<b>GET</b>	None	None	Returns 1 if the camera is ready, 0 otherwise
Current Inspection Number	<b>INSPNUM</b>	<b>GET</b>	None	None	Retrieve currently running inspection
Communications Tool Results	<b>COMMTOOL</b>	<b>GET</b>	None	CommTool Number or CommTool Name	Retrieve comm tool results, either by specifying its sequential number in the inspection

System Object, Component, or Activity	Object or Activity Identifier	Support Actions	Required Qualifiers	Optional Qualifiers	Comments
					(1,2,...,n) or by specifying its name. By default, data for the first comm tool will be retrieved.
Pass/Fail flag	<b>PASSFAILFLG</b>	<b>GET</b>	None	None	Retrieve the value of the Pass/Fail flag - 1 if pass, 0 if fail
System Error	<b>SYSERRFLG</b>	<b>GET</b>	None	None	Retrieve the value of the System Error - either 0 or 1
Frame Number	<b>FRAMENUM</b>	<b>GET</b>	None	None	Retrieve the current frame number
Pass Count	<b>PASSCNT</b>	<b>GET</b>	None	None	Retrieve the pass count
Fail Count	<b>FAILCNT</b>	<b>GET</b>	None	None	Retrieve the failed count
Iteration Count	<b>ITERCNT</b>	<b>GET</b>	None	None	Retrieve the Iteration Count
System Error Count	<b>SYSERRCNT</b>	<b>GET</b>	None	None	Retrieve the system error count
Missed Trigger Count	<b>MISSTRIGCNT</b>	<b>GET</b>	None	None	Retrieve the missed trigger count
I/O Line Status	<b>IOSTS</b>	<b>GET</b>	I/O line id, numeric, either <b>1</b> through <b>4</b> or <b>1</b> through <b>6</b>	None	Retrieve the cached status of the I/O line
Gain	<b>GAIN</b>	<b>GET</b>		None	Retrieve the gain
Gain	<b>GAIN</b>	<b>SET</b>	Positive Integer	None	Set the gain

System Object, Component, or Activity	Object or Activity Identifier	Support Actions	Required Qualifiers	Optional Qualifiers	Comments
Exposure	<b>EXPOSURE</b>	<b>GET</b>		None	Retrieve the camera exposure
Exposure	<b>EXPOSURE</b>	<b>SET</b>	Positive Number	None	Get the camera exposure
Frame Number Tag	<b>FRAMETAG</b>	<b>SET</b>	<b>ENABLE</b>	None	Enables frame number as command acceptance indicator
Frame Number Tag	<b>FRAMETAG</b>	<b>SET</b>	<b>DISABLE</b>	None	Disables frame number as command acceptance indicator
Frame Number Tag	<b>FRAMETAG</b>	<b>GET</b>	None	None	Retrieve the status of the frame tag indicator

## Coordinate tool

### Commands

Syntax	Description
<code>set coordtool <i>tool_name</i> <i>tool_number</i> x y angle</code>	Returns the specified Coordinate tool output.
<code>get coordtool <i>tool_name</i> <i>tool_number</i> x y angle</code>	Gets the value

## Math tool and the Remote Command Channel

### Commands

Syntax	Description
<code>set mathtool <i>tool_name</i> <i>tool_number</i> operand_1 operand_2</code>	Sets the specified tool operand, if it is a constant. Value should be a floating number.
<code>get mathtool <i>tool_name</i> <i>tool_number</i> operand_1 operand_2</code>	Gets the value of the specified tool operand, if it is a constant.

## String tool

### Commands

Syntax	Description
set stringtool <i>tool_name tool_number operand_1 operand_2</i>	Sets the specified tool operand, if it is a constant. Value should be a quoted string (see <a href="#">Character Strings 6.2.2.6.1 Character Strings</a> on page 200).
get stringtool <i>tool_name tool_number operand_1 operand_2</i>	Gets the value of the specified tool operand, if it is a constant.

## OCV Tool and the Remote Command Channel

### Commands

Syntax	Description
set ocvttool <i>tool_name tool_number exp_string value </i>	Sets the expected string, if it is a constant. The Value should be a quoted string containing printable ASCII characters (see <a href="#">Character Strings 6.2.2.6.1 Character Strings</a> on page 200).
get ocvttool <i>tool_name tool_number exp_string</i>	Gets the value of the expected string.

### RCC Return Values

RCC return values are numeric, and are listed below:

- 0 - command accepted. This return code is generated when a valid SET, GET, and EXEC command has been completely handled by the sensor. It may be followed by a command-specific return value or a completion code.

If the frame tag is enabled, the current frame number will be returned instead of 0 as command acceptance indicator.

- -100 - Invalid command entered by the user.
- Trigger and Product Change error codes:
  - -201 - Product change command attempted in the middle of the inspection
  - -202 – Trigger command attempted in the middle of product change
  - -203 – Trigger command is attempted when the inspection is not executing (sensor is idle)
  - -204 – Specified inspection slot is out of range
  - -205 – Trigger command attempted in the middle of the inspection
  - -206 – Product change command attempted in the middle of a product change
  - -207 – Product change command attempted while the sensor is in the Teach mode
  - -208 – Product change attempted when the GUI is connected, and the inspection is not executing
- Comm tool error codes
  - -301 – get/set tool command attempted while the inspection is not executing
  - -302 – get command issued before inspection is triggered for the first time – tool results unavailable
  - -303 – get/set tool command attempted in the middle of the inspection
  - -304 – get/set tool command attempted in the middle of the product change
  - -305 – Tool specified in get/set command not found in the inspection

- -306 – Requested comm tool is not configured for RCC
- -307 - Tool executed with an error or did not execute
- -308 - Specified tool operand is not a constant, and cannot be modified
- Reset command error codes
  - -401 – Reset command attempted in the middle of the inspection
  - -402 – Reset command attempted in the middle of the product change
- -500 – RCC commands are not accepted because the sensor is in the Playback mode
- Timeout error codes
  - -600 – Product change timeout occurred
  - -601 – Trigger timeout occurred
- -700 – Specified value is out of range
- -701 – Set Gain command attempted when the GUI is connected and the inspection is not executing
- -702 – Set Exposure command attempted when the GUI is connected and the inspection is not executing
- -800 – Product Change, Trigger or Get Commtool command attempted when either Product Change or Trigger Command timeout occurred, but the operation has not yet completed.

### Frame Tag Numbers

RCC provides user with a debug facility that allows users to correlate command completion with current frame numbers. This facility is enabled by issuing a SET FRAMETAG ENABLE command. This command will cause RCC to send the current frame number as the command acceptance code. This will allow users to track when each command was issued, and which frame it applies to.

For EXEC TRIGGER command, returned number will be the frame number at the completion of the inspection execution.

For EXEC TRIGGER command, returned number will be the frame number at the completion of the inspection execution.

For all other commands, the returned number is the current frame number.

### Command Processing

RCC commands are interpreted in the context of the running PPVS system. Due to the constantly changing system state caused either by external action or by previous RCC commands, certain rules are imposed on RCC command acceptance and processing. Please note that command acceptance does not constitute successful completion of the command.

1. EXEC TRIGGER command can be successfully accepted under the following conditions:
  - Inspection is Executing and is Ready
2. EXEC PRODCHANGE command can be successfully accepted under the following conditions:
  - Sensor is idle (inspection is not loaded), and the GUI is not connected
  - Inspection is Executing and is Ready
  - Sensor was previously product changed to an invalid slot
3. EXEC RESET command can be successfully accepted under the following conditions:
  - Sensor is idle (inspection is not loaded)

- Inspection is Executing and is Ready
4. SET GAIN or SET EXPOSURE commands can be successfully accepted under the following conditions:
    - Inspection is Executing and is Ready
  5. GET status, counter or flag commands can be accepted at any time. If issued when inspection is Executing but is not Ready, these values may change as the inspection is executing.
  6. GET COMMTOOL command can be successfully accepted if the inspection has been loaded. However, RCC may not have valid data until the inspection has been triggered (executed) at least once.

Commands with timeouts, such as EXEC TRIGGER and EXEC PRODCHANGE, will block processing of additional commands while they are executing if they are invoked without the NOWAIT option. Additional commands that are issued while processing is blocked will be queued, and will be processed in the order that they were received when the blocking command finishes its execution.

When blocking commands, such as EXEC TRIGGER and EXEC PRODCHANGE, are invoked with the NOWAIT option, GET commands that retrieve flags and status are accepted for processing. All other commands are rejected with an appropriate error code.

## RCC Log

RCC Log allows users to monitor and troubleshoot communication inputs and outputs.

Log consists of a circular buffer with up to 400 entries. These entries can be one of three types:

- IN – characters received in the input stream
- CMD – commands that were extracted after the frame start and frame end delimiters have been received
- OUT – formatted command output, with frame delimiters already included.

Log entries are time stamped with system time and sorted in the order they were received.

Non-displayable ASCII characters are shown in the ASCII Hex string form. The ASCII Hex strings are preceded by character sequence “\x” (backslash-lower-case-x). The ASCII Hex string will always be two characters long. For example, NULL will be converted to “\x00”, and carriage return will be converted to “\x0D”. To represent ASCII Hex digits, only upper case letters, A-F, are used.

Sample RCC log is given below:

```
0000000118.116 IN e
0000000118.116 IN x
0000000118.116 IN e
0000000118.116 IN c
0000000118.116 IN
0000000118.116 IN t
0000000118.116 IN r
0000000118.116 IN i
0000000118.116 IN g
0000000118.116 IN g
0000000118.116 IN e
0000000118.116 IN r
0000000118.116 IN \x0D
0000000118.116 IN \x0A
```

```
0000000118.116 CMD exec trigger
0000000118.483 OUT 0\x0D\x0A
```

In this example, command exec trigger was sent to RCC interface. The interface was configured to use no start frame delimiter, and carriage return (\x0D) and line feed (\x0A) as frame delimiters. As soon as valid frame delimiters were received, the command exec trigger was sent for processing, and the command response was sent back after inspection finished executing.

### Frame and Field Delimiters

The PresencePLUS GUI includes a drop-down list of Frame delimiters as follows:

- **<none>** for no delimiter
- \r for carriage return (<CR>)
- \n for line feed (LF)
- \r\n for carriage return followed by a line feed (CR-LF)
- \n\r for line feed followed by a carriage return (LF-CR)

In addition to the above field delimiters, you can enter other delimiter types keeping in mind the following:

- ASCII hex format can be used as a delimiter
- a NULL character can be used as a delimiter (specified in ASCII hex format)
- Frame delimiters can be multi-character sequences up to 20 characters long

The PresencePLUS GUI includes a drop-down list of Field delimiters as follows:

- **<none>** for no delimiter
- , for comma
- ; for semi-colon
- : for colon
- **<SPC>** for space
- \t for tab

In addition to the above field delimiters, you can enter other delimiter types keeping in mind the following:

- ASCII hex format can be used as a delimiter
- a NULL character can be used as a delimiter (specified in ASCII hex format)
- Field delimiters can be multi-character sequences up to 10 characters long

### Character Strings

Communications Tool configured for Barcode or String Tool output may produce strings that contain non-printable ASCII characters, such as carriage returns, line feeds, and characters in the upper ASCII range.

To output these strings, the following encoding rules are used:

- Tool output strings will be enclosed in double quote characters, “ ”.
- Any non-printable ASCII character, including NULL, will be converted to its ASCII Hex equivalent. The ASCII Hex string will be preceded by character sequence “\x” (backslash-lower-case-x). The ASCII Hex string will always be two characters long. For example, NULL will be converted to “\x00”, and carriage return will be converted to “\x0D”. To represent ASCII Hex digits, only upper case letters, A-F, will be used.
- Any backslash encountered in the Barcode or String Tool data will be converted to its ASCII Hex equivalent, “\x5C”.



- Any double quote encountered in the Barcode or String Tool will be converted to its ASCII Hex equivalent, "\x22".

For RCC input strings, the formatting rules are expanded to accommodate readability as follows:

- Carriage return can be specified as character sequence "\r" (backslash-r).
- Line feed can be specified as character sequence "\n" (backslash-n).
- Double quote can be specified as character sequence "\"" (backslash-doublequote).
- Backslash can be specified as character sequence "\\" (backslash-backslash).
- tab can be specified as character sequence "\t" (backslash-t).
- Embedded NULLL characters are not allowed.

## 6.2.3 PresencePLUS/Kawasaki Vision Guidance and Inspection

### *Integrating Banner Vision Sensors with Kawasaki Robot Controllers*

#### Quick Start

This document describes how to integrate a Banner *PresencePLUS* sensor with Kawasaki Robot Controllers, and:

- includes instructions for establishing communications between the *PresencePLUS* sensor and a Kawasaki Robot Controller
- describes how to set up a sample *PresencePLUS* vision inspection
- provides a sample Kawasaki AS Language program

Below is a quick overview of the procedure for integrating *PresencePLUS* sensors with Kawasaki Robot Controllers and, where noted, more details are provided in the document subsections.

Main Steps	Tasks to Complete
Establish communication between the <i>PresencePLUS</i> sensor and the Kawasaki Robot Controller. See <a href="#">Establishing Sensor/Robot Communication 6.2.3.3</a> <a href="#">Establishing Sensor/Robot Communication</a> on page 67	<ol style="list-style-type: none"> <li>1. Install and physically connect a Banner <i>PresencePLUS</i> Vision Sensor to a Kawasaki controller.</li> <li>2. Configure <i>PresencePLUS</i> and Kawasaki controller IP addresses.</li> <li>3. Configure the <i>PresencePLUS</i> Remote Command Channel.</li> </ol>
Create and save a <i>PresencePLUS</i> Inspection. See <a href="#">Creating the PresencePLUS Inspection 6.2.3.4</a> <a href="#">Creating the PresencePLUS Inspection</a> on page 69 for more details.	<ol style="list-style-type: none"> <li>1. Create a new inspection and configure Vision tools to produce the desired part location data that outputs it to the RCC interface. The sample inspection described in this document: <ul style="list-style-type: none"> <li>• Locates a part</li> <li>• Tests for presence of the part</li> <li>• Outputs X, Y, and Rotation about the Z-axis offsets</li> </ul> </li> <li>2. Save and then start the inspection.</li> </ol>
Program the Kawasaki controller to connect and issue commands to the <i>PresencePLUS</i> sensor . A <a href="#">sample AS program</a> is provided to get you started.	<ol style="list-style-type: none"> <li>1. Load the sample AS Language program onto robot controller. The sample program implements the following actions: <ul style="list-style-type: none"> <li>• Connects to the RCC.</li> <li>• Triggers vision sensor and wait for inspection to complete.</li> </ul> </li> </ol>

Main Steps	Tasks to Complete
	<ul style="list-style-type: none"> <li>• Determines pass/fail condition of the inspection.</li> <li>• Gets the X, Y, and Rotation about Z-axis offsets.</li> <li>• Closes the connection to the RCC.</li> </ul> <p>2. Run program.</p> <p> <b>Note:</b> The IP address and port number within the sample AS Language program must be modified to match the IP address and port number of the <i>PresencePLUS</i> sensor.</p>

## Overview

The *PresencePLUS* Proll and P4 sensor families are cost-effective, easy-to-use camera systems with advanced visual inspection capability. Where other vision systems can be difficult to configure, the *PresencePLUS* software is straight-forward. This enables users with minimal experience with vision systems to quickly set an inspection that inspects and accurately determines product position, and to integrate the *PresencePLUS* system into their environment.

To facilitate the implementation of *Presence PLUS* Vision Sensors with robots to provide vision guidance and/or product quality tests on a production line, *Presence PLUS* supports a user-configurable, ASCII-based, TCP /IP communications interface called the Remote Command Channel. The RCC supports a Kawasaki protocol specifically designed to communicate with Kawasaki C/D/D+ robot controllers.

### Summary of Remote Command Channel Features

The RCC within the Banner *PresencePLUS* Sensor is configured as a Server device. This means that it does not initiate connections on its own, but instead waits for a client (robot controller) to connect to it. The *PresencePLUS* Remote Command Channel (RCC) supports the following features:

- Triggering the sensor and performing product changes
- Checking sensor status, such as pass, fail, and I/O line state
- Retrieving tool results, and sensor counters including pass/fail
- User-defined frame (command) delimiters and output field separators
- Logging input and output data to assist with RCC/MMI debugging

### Prerequisites — Kawasaki Robot

This procedure assumes that you are using an Ethernet-enabled Kawasaki robot controller configuration such as:

- Kawasaki C Series Controller with a 1HA Ethernet board option
- Kawasaki D Series Controller with a 1KN or 1QN Ethernet board option
- Kawasaki D+ Series Controller with an integrated 1RA Ethernet board

### Related Documentation

For more information relating to Banner's Vision Sensors and Kawasaki Robot Controllers, refer to the following sources:

- Kawasaki Robot TCP/IP Function Instruction Manual
- Kawasaki D Series Controller AS Language Reference Manual
- *PresencePLUS* electronic Help

## Establishing Sensor/Robot Communication

Step 1	Main Tasks to Complete
<p><b>Install and connect a <i>PresencePLUS</i> Vision Sensor</b></p>	<ol style="list-style-type: none"> <li>1. Install Banner <i>PresencePLUS</i> Vision Sensor version 2009R1B or later.</li> <li>2. Connect the Vision Sensor using one of the following approaches: <ul style="list-style-type: none"> <li>• connect to an existing Ethernet network via a switch or hub using a straight-through Ethernet cable with RJ45 connectors</li> <li>• connect directly to the Kawasaki controller using a cross-over Ethernet cable with RJ45 connectors.</li> </ul> </li> <li>3. Configure both the <i>PresencePLUS</i> sensor and the Kawasaki controller with static IP addresses.</li> </ol>

Step 2	Main Tasks to Complete
<p><b>Configure <i>PresencePLUS</i> Ethernet ports:</b> The <i>PresencePLUS</i> Sensor supports user-assignable TCP/IP ports. This assignment is</p>	<ol style="list-style-type: none"> <li>1. <b>Start the <i>PresencePLUS</i> software.</b></li> <li>2. <b>Connect to the sensor.</b></li> <li>3. Click on the <b>System</b> button in the upper right corner of the <i>PresencePLUS</i> GUI to display the System Setup screen.</li> <li>4. Click on the <b>Communication</b> tab to display the Communication configuration dialog.</li> </ol>

**Step 2****Main Tasks to Complete**

performed from the System Setup Dialog, Communications tab

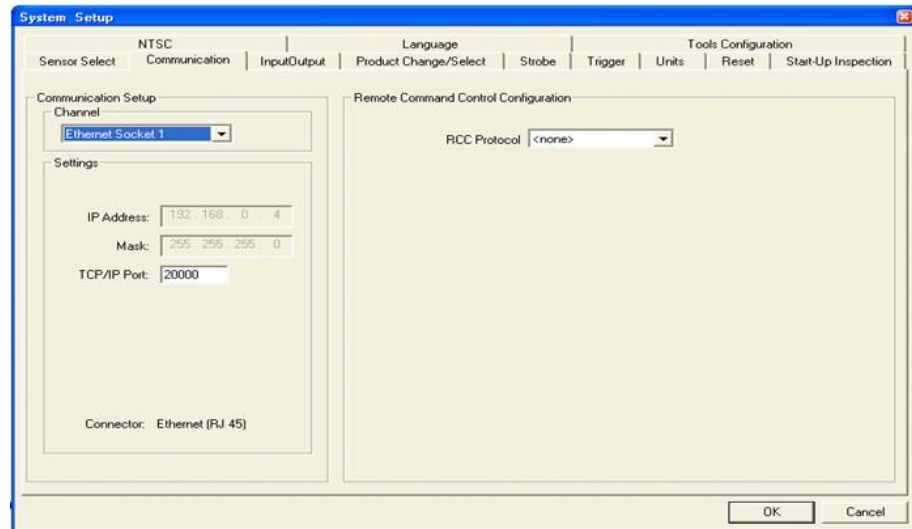

The default Ethernet port assignments are from 20000 to 20009.

- 👉 **Note:** Valid user TCP/IP port numbers for *PresencePLUS* sensors are in the range of 1024 through 65535. The *PresencePLUS* GUI will provide automatic notification if an attempt to use a reserved port is made. Any changes to the port assignment must be reflected in the AS Language program included in this document .

**Step 3****Main Tasks to Complete**

**Configure the *PresencePLUS* Remote Command Channel (RCC)**

1. Click on the **RCC Protocol drop-down menu**, and select "Kawasaki" from the menu. The default protocol configuration for Kawasaki robot is displayed.

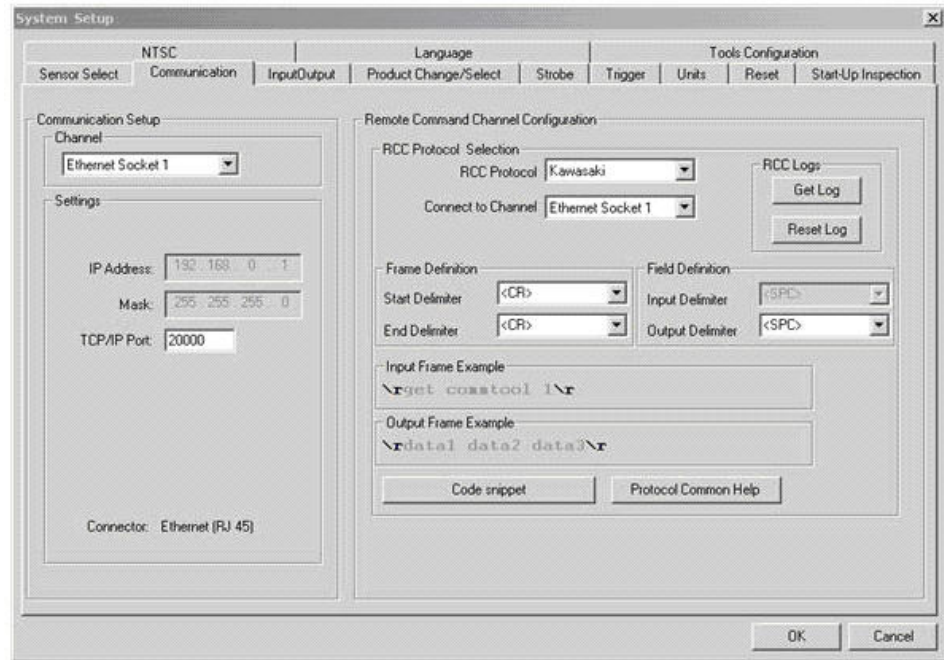
**Step 3****Main Tasks to Complete**

2. Click the **OK** button to accept the configuration.

**Kawasaki Protocol Defaults**

The default Kawasaki protocol configuration parameters are:

- Ethernet Socket 1 configured for TCP/IP Port 20000 as the communications channel
- No Frame Start (Command Start) delimiter
- Carriage Return/Line Feed as Frame End (Command End) delimiter
- Space as the input command field separator
- Comma as the output field separator.

 **Note:** You can adjust each of these parameters as necessary, but corresponding adjustments will have to be made to the sample AS Language program provided to enable successful communication.

**Creating the PresencePLUS Inspection****Step 1****Main Tasks to Complete**

**Enable the Coordinate Tool in**

1. Click the **System** button in the upper-right corner of the *PresencePLUS* GUI.

Step 1	Main Tasks to Complete
--------	------------------------

the Tool Configuration dialog.

2. Select the **Tools Configuration** tab.
3. Scroll down to the **Coordinate Tool**, and then select the checkbox next to it, as shown below.
4. Click the **OK** button to close the Tool Configuration dialog.

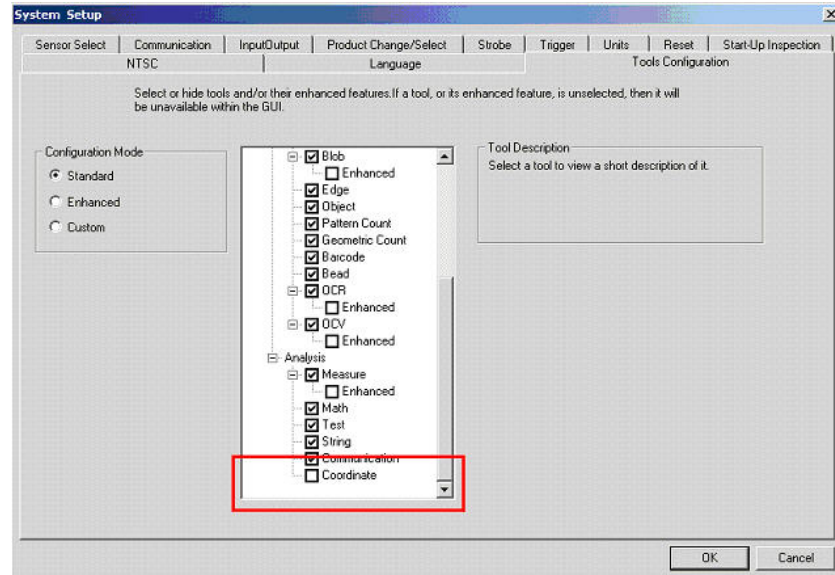

Step 2	Main Tasks to Complete
--------	------------------------

**Create a New Inspection** using Setup.

1. In the *PresencePLUS* GUI, create a new inspection by pressing the **Setup** button in the upper-left corner of the GUI.
2. Capture an image of the part to locate.
3. Press the **Goto Tools** button in the lower-right corner of the Setup tab.

Step 3	Main Tasks to Complete
--------	------------------------

**Add a Geometric Find tool** to locate

1. In the *PresencePLUS* GUI, click the **Location Tools** tab.

**Step 3****Main Tasks to Complete**

the part within the field-of-view.



2. Click the **Geometric Find** button.
3. Draw the tool **ROI (Region of Interest)** to select the image feature of interest as shown below.



4. Click the **Apply** button to accept the ROI.
5. Click the **Next** button to return to the Tools menu.

**Step 4****Main Tasks to Complete**

**Add a Coordinate tool** to provide locational data for the Robot.

1. In the *PresencePLUS* GUI, click the **Analysis Tools** tab.
2. Click the **Coordinate tool** button to create a Coordinate tool.

3. Select **Offset Only** from the **Tool List Filter** drop-down menu.

4. Click the **Next** button to return to the Tools menu.

 **Note:** The X, Y and Rotation selections will default to GF\_1.



**Step 5**

**Add a Test tool** to receive a positive confirmation that the inspection ran successfully; that is, the part was found.

**Main Tasks to Complete**

1. In the *PresencePLUS* GUI, click the **Analysis Tools** tab.
2. Click the **Test tool** button.
3. Select Coordinate Tool (COORD\_1) from the Input 1 drop-down list.

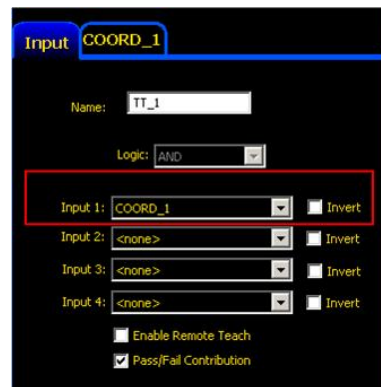

4. Click on the Coordinate Tool (COORD\_1) tab and make sure that the checkmark next to the X-Coordinate value checked. Enter 0 (zero) in the Min column and a large number (e.g., 1000) in the Max column.

**Note:** These settings will cause the Test tool to pass all resulting X values, but fail if the X value is invalid (that is, if the part is not found).

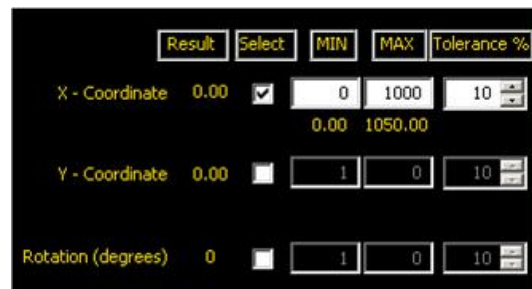

5. Uncheck other values.

**Step 5 Main Tasks to Complete**

6. Click the Back button.
7. Click the Next button to exit the Test Tool configuration.

**Step 6 Main Tasks to Complete**

**Save and Start Inspection** In the *PresencePLUS* GUI, click the **Go To Run** button. When prompted to save the inspection:

1. Enter a name in the **Inspection Name** field.

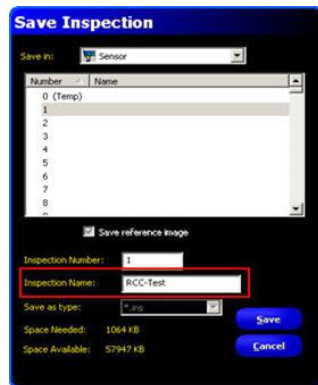

2. Click on the **Save** button.
3. Once the inspection is saved, click the **Start** button to start the inspection.

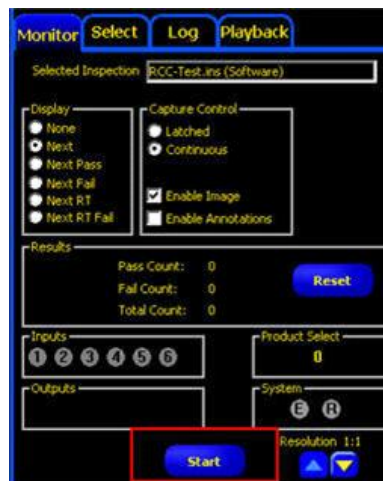

## Kawasaki AS Language Sample

This sample AS Language code snippet will assist with the integration of a Banner PresencePLUS Vision Sensor and a Kawasaki C/D/D+ Series Robot Controller.

In this example, the Banner Remote Command Channel (RCC) has been configured to use the Kawasaki RCC Protocol with Ethernet Socket 1, all other settings are default (TCP port 20000, command and response frame start delimiter is empty string (<none>) with an end delimiter of carriage return-linefeed (\r\n), and the field output delimiter is comma (,).

This example assumes that a Banner PresencePLUS inspection that produces X, Y and Angle offsets has been loaded into the PresencePLUS Vision Sensor and has been started with the PresencePLUS GUI. These offsets will then be obtained and stored in the following variables:

- X\_offset is the offset (in units set in camera) along the horizontal axis of the image, increases to the right
- Y\_offset is the offset (in units set in camera) along the vertical axis of the image, increases downward
- Rz\_offset is the angular offset (in degrees) about the Z-axis, increases clockwise

This program implements the following actions:

1. Connect to the RCC.
2. Issue EXEC TRIGGER and wait for inspection to complete.
3. Determine pass/fail condition of the inspection.
4. Get the X, Y, and Rotation about Z-axis offsets.
5. Close the connection to the RCC.

If any failure occurs, such as a TCP communications failure or a RCC command error, then the connection to the RCC will be severed within this example program.

```
.PROGRAM banner_vision()
; Global variables
$cmd_del = $CHR(13)+$CHR(10)
$coord_del = ","
tcp_sock_id = -1      ; TCP/IP socket id for the camera

; Local variables
.ret_val = -1
.$cmd_str = ""      ; Used for commands to camera
.$rcv_str = ""      ; Used for incoming data from camera
.$rsp_str = ""      ; Used for response parsing from camera

;
; Open TCP socket and connect to RCC
;
```

```
CALL tcp_open(.ret_val, 20000)
IF .ret_val < 0 THEN
    PRINT "Unable to connect to RCC"
    RETURN
END

;

; Trigger the camera and wait for the inspection to complete
;

; Send Trigger to camera and wait for the inspection to complete
.$cmd_str = "EXEC TRIGGER"+$cmd_del
CALL tcp_send(.ret_val, .$cmd_str)
IF .ret_val < 0 GOTO tcp_error

; Read command response from camera
.$rcv_str = ""
CALL tcp_recv(.ret_val, .$rcv_str)
IF .ret_val < 0 GOTO tcp_error

; Decode command response - a response of zero indicates that
; the command was accepted for processing, a negative value
; indicates that an error has occurred.
.$rsp_str = $DECODE(.$rcv_str, $cmd_del, 0)
.ret_val = VAL(.$rsp_str)
IF .ret_val < 0 GOTO cmd_error          ; Trigger failed

;

; Determine whether the inspection passed or failed
;

; Send command to camera to determine if the inspection passed
; the inspection and found the desired part
.$cmd_str = "GET PASSFAILFLG"+$cmd_del
CALL tcp_send(.ret_val, .$cmd_str)
IF .ret_val < 0 GOTO tcp_error

; Read command response from camera
.$rcv_str = ""
CALL tcp_recv(.ret_val, .$rcv_str)
IF .ret_val < 0 GOTO tcp_error          ; Get command failed

; Decode command response
.$rsp_str = $DECODE(.$rcv_str, $cmd_del, 0)
.ret_val = VAL(.$rsp_str)
IF .ret_val < 0 GOTO cmd_error          ; Get Pass/Fail failed
$temp = $DECODE(.$rcv_str, $cmd_del, 1) ; Remove frame delimiter

; Decode the Pass/Fail status data returned by the Get command
.$rsp_str = $DECODE(.$rcv_str, $coord_del, 0)
.passfail = VAL(.$rsp_str)
IF .passfail <> 1 GOTO notfnd_error
```

```

;
; Obtain the X, Y, and Rz offset data
;

; Send command to camera to acquire the Communication Tool
; result data
.$cmd_str = "GET COORDTOOL"+$cmd_del
CALL tcp_send(.ret_val,.$cmd_str)
IF .ret_val < 0 GOTO tcp_error

; Read command response from camera
.$rcv_str = ""
CALL tcp_recv(.ret_val, .$rcv_str)
IF .ret_val < 0 GOTO tcp_error

; Decode command response
.$rsp_str = $DECODE(.$rcv_str, $cmd_del, 0)
.ret_val = VAL(.$rsp_str)
IF .ret_val < 0 GOTO cmd_error          ; Get Commtool failed

$stemp = $DECODE(.$rcv_str, $cmd_del, 1) ; Remove frame delimiter

; Decode the X offset data
.$rsp_str = $DECODE(.$rcv_str, $coord_del, 0)
X_offset = VAL(.$rsp_str)
$stemp = $DECODE(.$rcv_str, $coord_del, 1) ; Remove field delimiter

; Decode the Y offset data
.$rsp_str = $DECODE(.$rcv_str, $coord_del, 0)
Y_offset = VAL(.$rsp_str)
$stemp = $DECODE(.$rcv_str, $coord_del, 1) ; Remove field delimiter

;Decode the Rz offset data -- rotation about the Z axis
.$rsp_str = $DECODE(.$rcv_str, $coord_del, 0)
O_offset = VAL(.$rsp_str)
$stemp = $DECODE(.$rcv_str, $coord_del, 1) ; Remove field delimiter

;
; Handle new coordinate offsets
;
PRINT X_offset, Y_offset, Rz_offset
POINT pick = frame1+TRANS(X_offset, Y_offset, ,Rz_offset)
HOME
LAPPRO pick,100
LMOVE pick
CLAMP 1
LDEPART 100
HOME

; Part not found error
notfnd_error:
PRINT "The part was not found"
GOTO all_done

```

```
; TCP error
tcp_error:
  PRINT "Error during send or receive via TCP:", .ret_val
  GOTO all_done

; RCC Command error
cmd_error:
  PRINT "Error during command to camera:", .ret_val
  GOTO all_done

; Done with program
all_done:
  CALL tcp_close
.END

;
; Open a TCP connection to the RCC using specified TCP port number
;
.PROGRAM tcp_open(.ret_val, .port)

  .ret_val = 0          ; Initialize the return value
  .retry_count = 0     ; Initialize the retry count

  ; Set the IP address to 192.168.0.1
  ip[1] = 192
  ip[2] = 168
  ip[3] = 0
  ip[4] = 1

connect:

  ; Connect to the RCC port
  TCP_CONNECT tcp_sock_id, .port, ip[1]

  ; Check whether connection was established
  IF tcp_sock_id < 0 THEN
    IF .retry_count >= 5 THEN
      ; Number of retries exceeds 5, exit with error
      PRINT "Unable to establish connection with camera"
      .ret_val = -1
      GOTO connect_error
    ELSE
      ; Increment the retry count and try again
      .retry_count = .retry_count + 1
      PRINT "TCP_CONNECT error - attempt #", .retry_count
      GOTO connect
    END
  ELSE
    PRINT "Established connection, socket id = ", tcp_sock_id
  END

; Error occurred during connection attempt(s)
```

```

connect_error:
    RETURN

.END

;
; Close the TCP connection
;
.PROGRAM tcp_close()

    .ret_val = 0                ; Initialize the return value

    TCP_CLOSE .ret_val, tcp_sock_id

    ; Check for errors
    IF (.ret_val < 0) THEN
        PRINT "Unable to close TCP connection, error id = ", .ret_val
    ELSE
        PRINT "TCP Connection has been closed"
    END
.END

;
; Receive data over TCP connection
;
.PROGRAM tcp_recv(.ret_val, .$receive)
    .ret_val = 0                ; Initialize the return value
    .error_return = -99         ; Return value from TCP_RECV
    .timeout_recv = 60          ; Timeout of 60 seconds
    .max_recv_len = 255         ; Maximum length of single string element
    .$receive = ""              ; Empty the return string
    .num_elem_recv = 0          ; Number of elements received

    ; Read the TCP socket
    TCP_RECV .error_return, tcp_sock_id, .$recv_buf[1], .num_elem_recv,
    .timeout_recv, .max_recv_len

    ; Process data
    IF .error_return < 0 THEN
        PRINT "Error receiving data, TCP_RECV error #", .error_return
        .ret_val = -1
    ELSE
        IF .num_elem_recv > 0 THEN

            ; Ensure the combined return string element lengths do
            ; not exceed 255 (maximum allowed length of string) - the
            ; multiplication allows .max_recv_len to be less than 255
            IF .num_elem_recv * .max_recv_len <= 255 THEN

                ; Copy all of the received elements into output buffer
                FOR .j = 1 TO .num_elem_recv
                    .$receive = .$receive+.$recv_buf[.j]
                END
            END
        END
    END

```

```

        ELSE
            PRINT "Received string too long"
            .ret_val = -1
        END
    ELSE
        PRINT "Invalid number of elements received"
        .ret_val = -1
    END
END
.END

;
; Send data over the TCP connection
;
.PROGRAM tcp_send(.ret_val, .$data)

    .ret_val = 0                ; Initialize function return code
    .$send_buf[1] = .$data     ; Data to send
    .buf_num = 1               ; Number of array elements
    .send_timeout = 60        ; send timeout
    .error_return = 0         ; send error return code

    TCP_SEND .error_return, tcp_sock_id, .$send_buf[1], .buf_num,
send_timeout

    IF .error_return < 0 THEN
        .ret_val = -1
        PRINT "TCP SEND error in SEND, error = ", .error_return
    END
.END

```

## PresencePLUS Communication Testing

The RCC interface is not a true Telnet interface, although you can use Telnet to test it. Some of the control keys, such as Back Space and Delete will not cause mistyped characters to be erased. Instead, they will be passed on and consumed by the RCC interface. Other control characters will also be consumed by the interface without the usual Telnet actions.

However, you can test the RCC connection by using a Telnet application to connect to the sensor using the port that you configured for the RCC (20000 by default). To function correctly, you must set the Newline transmit value within the Telnet application to be the same as the Command Line End delimiter that you selected in the RCC configuration menu (Carriage Return/Line Feed by default).

After you have successfully connected to the RCC, you can enter RCC commands and observe responses. For example, you can enter **get onlinests** to retrieve the online status of the sensor. Another example is you can type in the command **exec trigger**, this will result in the sensor to be triggered, the inspection will be executed, and you should see the inspection output in the GUI. For a complete list of RCC commands and return codes, please refer to the *PresencePLUS* electronic documentation - accessible through the *PresencePLUS* GUI.



## 6.2.4 Using Custom\_ASCII to Communicate with an External Device Over Ethernet

To select **Custom\_ASCII**, click on the RCC Protocol pull-down menu, and select **Custom\_ASCII** from the menu. The protocol configuration for **Custom\_ASCII** is displayed as shown below. The default protocol configuration parameters are:

- Ethernet Socket 1 configured for TCP/IP 20000 as the communications channel
- No Frame Start (Command Start) Delimiter — **<none>**
- Carriage Return/Line Feed as Frame End (Command End) Delimiter — **\r\n**
- Comma as the Output Delimiter for the Field Definition — **,**
- Space as the Input Delimiter for the Field Definition — **<SPC>**

The screenshot displays the 'Remote Command Channel (RCC) Configuration' window. The 'Communication Setup' section on the left shows 'Channel' set to 'Ethernet Socket 1', 'IP Address' as '192.168.0.4', 'Mask' as '255.255.255.0', and 'TCP/IP Port' as '20000'. The 'RCC Protocol Selection' section shows 'RCC Protocol' set to 'Custom\_ASCII' and 'Connect to Channel' set to 'Ethernet Socket 1'. The 'Frame Definition' section shows 'Start Delimiter' as '<None>' and 'End Delimiter' as '<CR-LF>'. The 'Field Definition' section shows 'Input Delimiter' as '<SPC>' and 'Output Delimiter' as ','. Below these sections are 'Input Frame Example' showing 'get commtool 1\r\n' and 'Output Frame Example' showing 'data1,data2,data3\r\n'. The 'Tools Configuration' section at the top right includes 'RCC Logs' with 'Get Log' and 'Reset Log' buttons. An 'OK' button is located at the bottom right.

## 6.3 P4 Input/Output Tab

Use this tab to set the functionality of the four programmable I/O connections.

**Inputs and Outputs** You can select Trigger, Product Change, Remote Teach, and Discrete inputs and outputs as either NPN (current sourcing) or PNP (current sinking). Once NPN or PNP is selected, **all** inputs and outputs are either NPN or PNP.

**I/O, Pin #, Function** I/O 1 through 4 in the I/O column correspond to Pins 5 through 8 in the Pin # column. Options from the drop-down list are:

- **General Input:** Input to the sensor.
- **General Output:** Output from the sensor that can be selected in a Test tool.
- **Pass:** Active when the entire inspection passes.
- **Fail:** Active when the inspection fails.
- **System Error:** Active when a system error occurs.
- **Ready:** Active when the sensor is ready to accept another trigger.
- **Product Select:** Used in conjunction with Product Change to select inspection locations at which to begin execution.

**Normally Open/Closed**

Select the state (open or closed) that the output will take when not active.

- **Normally Open:** The output becomes **active** when the logic condition controlling the output becomes **True**.
- **Normally Closed:** The output becomes **inactive** when the logic condition controlling the output becomes **True**.

**Output Delay**

Output Delay is the time from a trigger to start an inspection until the Sensor output turns ON. It is available only for general outputs.

 **Note:** If processing time is longer than the output delay, the output will become active immediately after the processing is finished.

**Output Duration**

This option is available only for the general outputs; the other outputs (Pass, Fail, System Error, and Ready) are latched only.

- **Latched:** Active until the condition changes.
- **Time:** Active for a specific length of time.

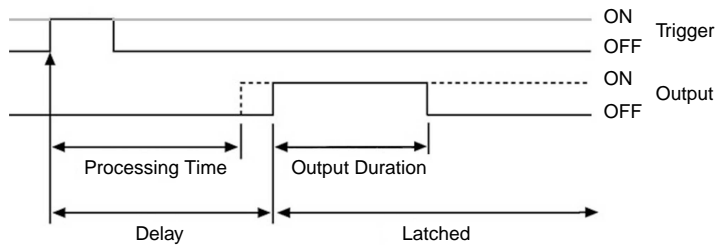

### Input/Output Tab

#### P4 Input/Output Tab

**System Setup**

Sensor Select
Communication
InputOutput
Strobe
Units
Reset
Start-Up Inspection
NTSC
Language
Tools Configurati...

**Inputs**

Current Sourcing (NPN Driver Required)

Current Sinking (PNP Driver Required)

**Outputs**

Current Sinking (NPN)

Current Sourcing (PNP)

**Product Select Typ...**

One pulse set...

Three pulse set...

**System Inputs**

	Pin #4	Trigger	Pin #3	Product Change	Pin #2	Remote Teach
I/O	Pin #	Function	Normally	OutputDelay	Output Duration	
1	5	Ready	<input checked="" type="radio"/> Open <input type="radio"/> Closed	0 ms	<input checked="" type="radio"/> Latched <input type="radio"/> Time	
I/O	Pin #	Function	Normally	OutputDelay	Output Duration	
2	6	Ready	<input checked="" type="radio"/> Open <input type="radio"/> Closed	0 ms	<input checked="" type="radio"/> Latched <input type="radio"/> Time	
I/O	Pin #	Function	Normally	OutputDelay	Output Duration	
3	7	General Input	<input checked="" type="radio"/> Open <input type="radio"/> Closed	0 ms	<input checked="" type="radio"/> Latched <input type="radio"/> Time	
I/O	Pin #	Function	Normally	OutputDelay	Output Duration	
4	8	General Input	<input checked="" type="radio"/> Open <input type="radio"/> Closed	0 ms	<input checked="" type="radio"/> Latched <input type="radio"/> Time	

## 6.4 Strobe Tab

Use the Strobe tab to set the strobe signal for a strobed light source. The strobe signal is a +5V dc TTL signal. Fields in the System Setup window's Strobe tab are described below:

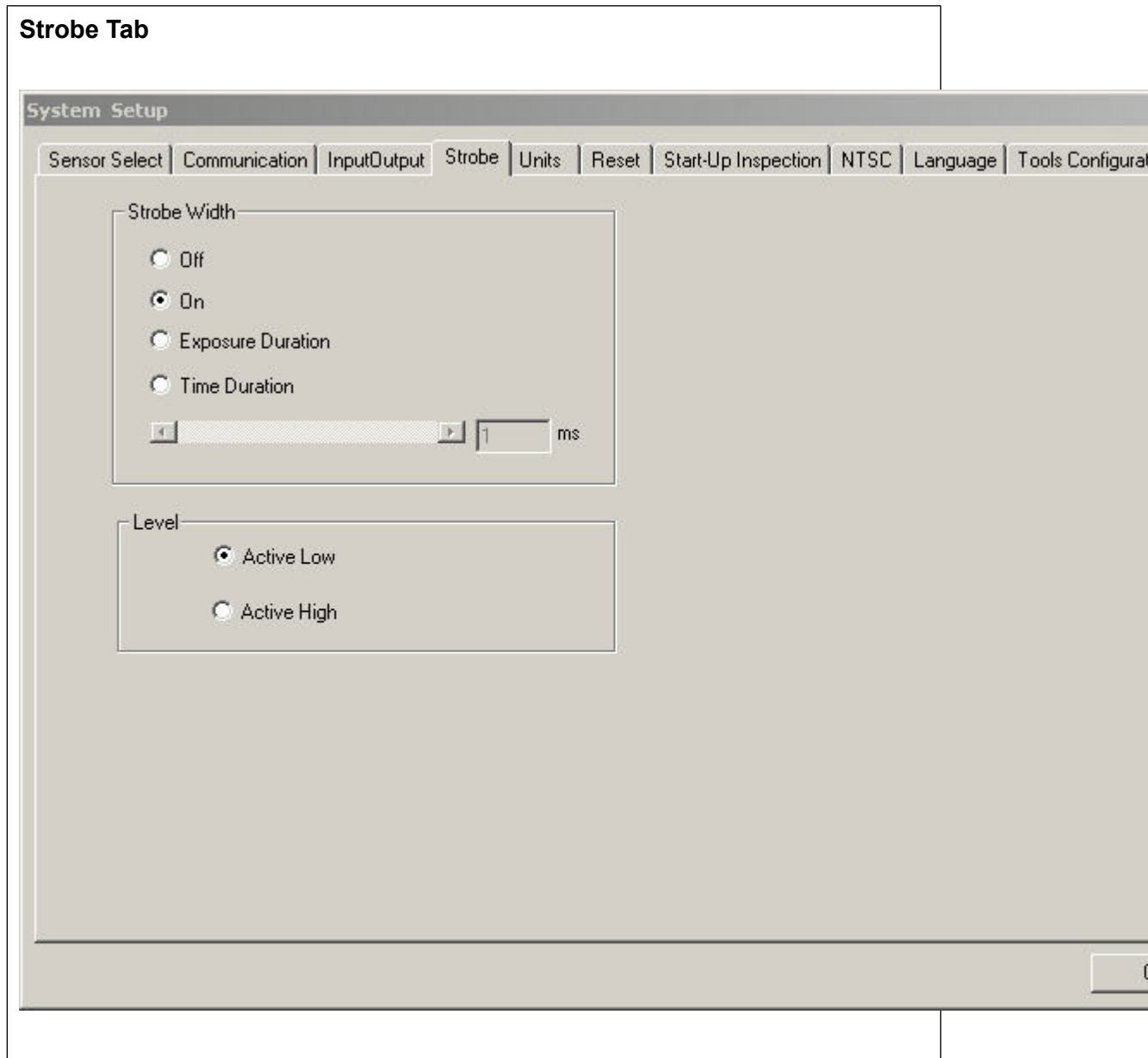

### 6.4.1 Strobe Width

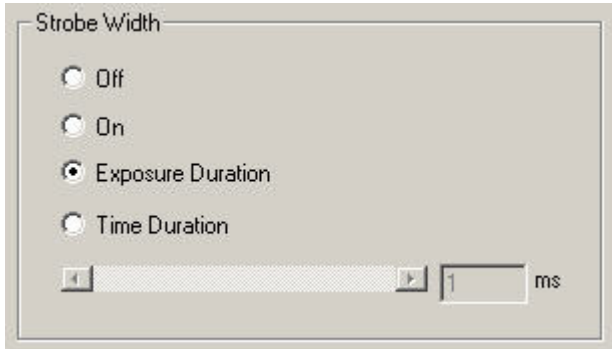

Strobe Width Option	Description
<b>Off</b>	The strobe output never becomes active (light off).
<b>On</b>	The strobe output remains active (light on).
<b>Exposure Duration</b>	The strobe output is active only while the sensor is acquiring an image. This is the default.
<b>Time Duration</b>	Sets the duration for active strobe output from the initial valid trigger (minimum pulse width has been satisfied) to the end of the duration. The range is from 0 to 4,000 ms.

## 6.4.2 Level

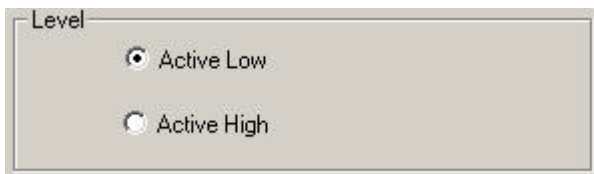

- **Active Low** -- When given a 0V dc signal, it turns on. This is the default.
- **Active High** -- When given a +5V dc signal, it turns on.

## 6.5 Units Tab

Use the Units tab to scale pixels to Engineering units (inches, millimeters, centimeters, etc.) as shown in Units tab shown below. To scale pixels, follow the instruction

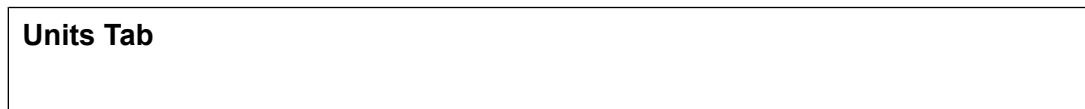

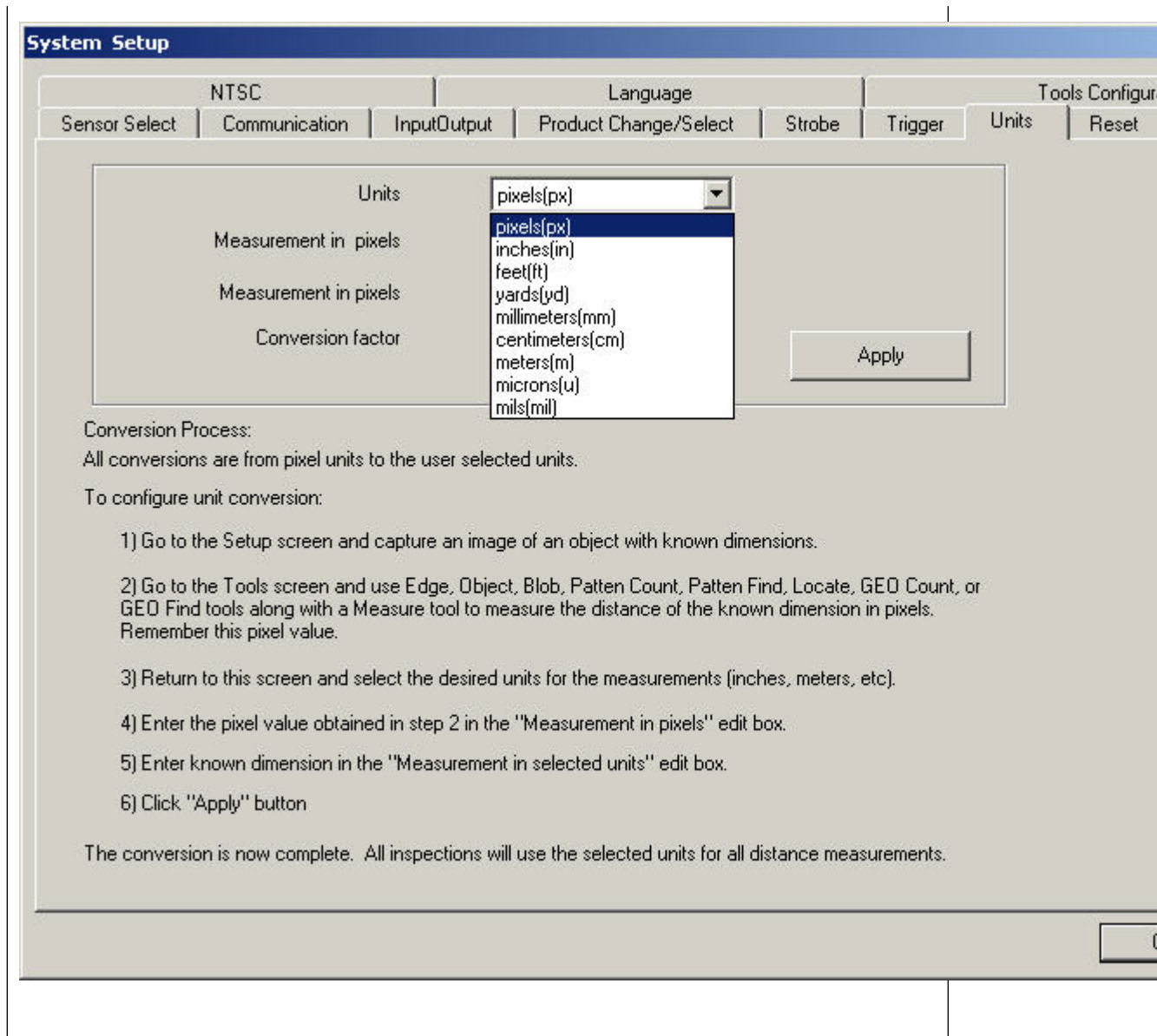

## 6.6 Reset Tab

Use the Reset tab to read sensor error codes, clear system errors and reestablish Sensor communications.

Option	Description
<b>Reset Error Flag</b>	Click to clear the sensor's Red Error LED.
<b>Reset Error Log</b>	Click to clear the error log.
<b>System Reset</b>	Click to reboot the Sensor. (This is a system reboot and will take several seconds).

Option	Description
<b>Get Error Log</b>	Click to display the System Log icon in the Navigation/Results window. The System Log records information about all system failures (such as communication errors between the PC and the Sensor).

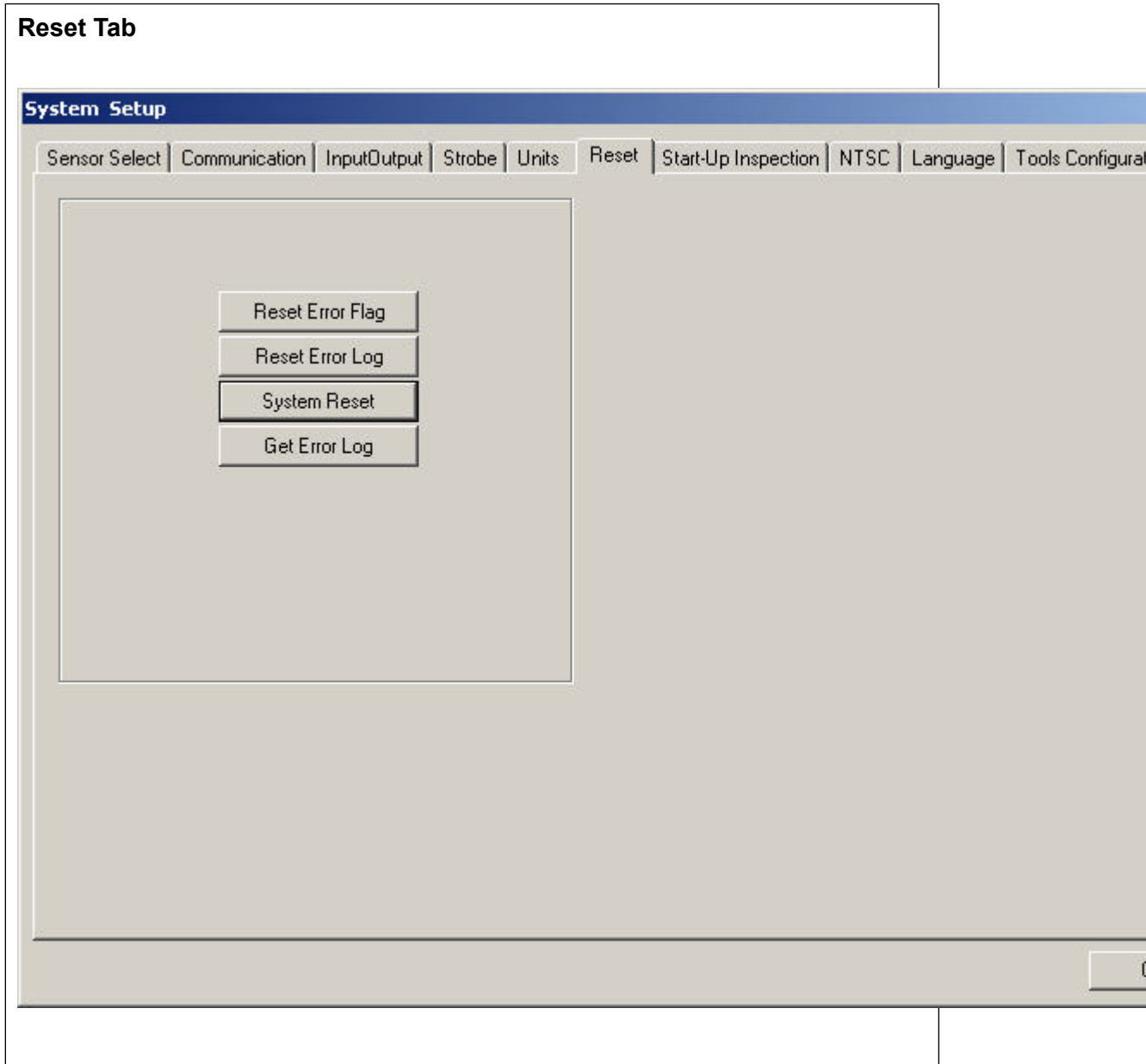

## 6.7 Start-Up Inspection Tab

The options on the Start-Up Inspection tab:

- Click on **Setup Mode** if you want the camera to start in Setup Mode after it is powered down.
- Click on **Inspection Name**, and select an inspection from the drop-down list to have the sensor start up to run.

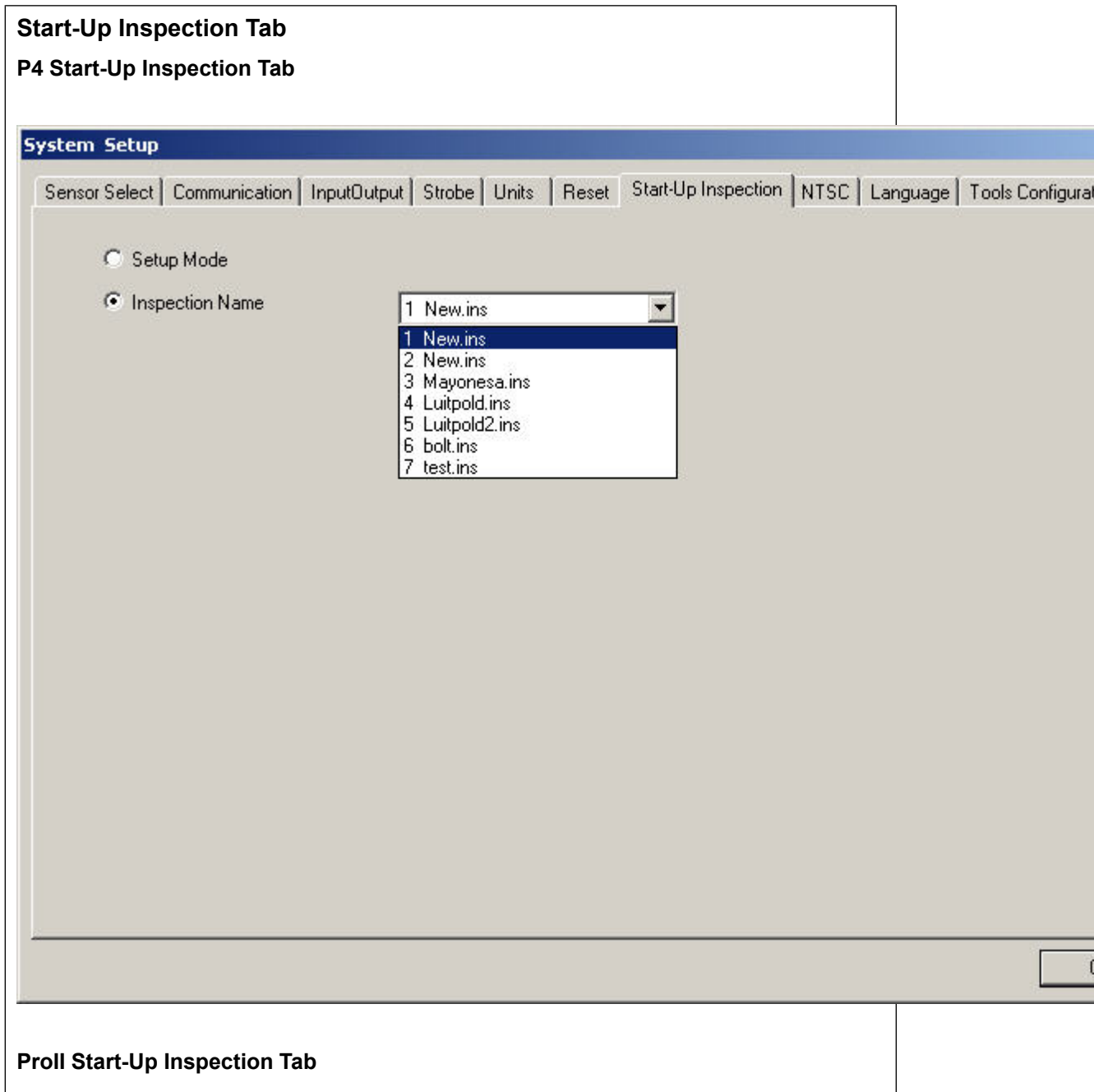



## 6.8 NTSC Tab

The **Zoom Level** adjustment on the NTSC tab is available only for single function, low-resolution sensors such as the Area and Geo. From the drop-down list, select the desired zoom level as it will appear on the optional NTSC video monitor that you can attach to the sensor. The default is 4:1.

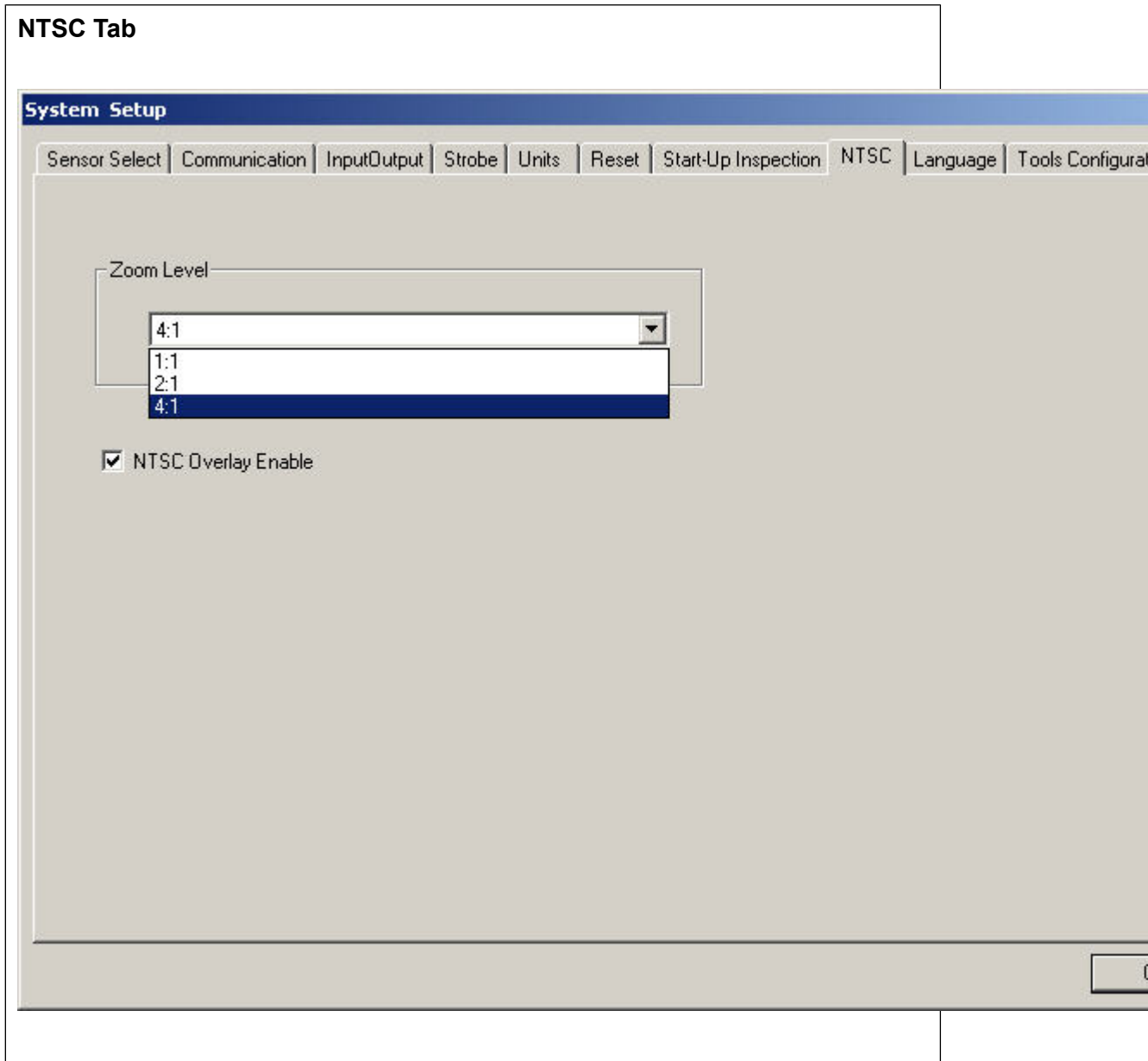

## 6.9 Language Tab

In the Languages tab, click on the down arrow for a drop-down list of the languages installed from the *PresencePLUS* software CD.

Click on the desired language, then click Apply. At the next start-up, the PresencePLUS software will use the selected language.

To save changes and exit the System Setup window, click OK. To exit the System Setup window without making any changes, click the X in the upper-right hand corner of the window.

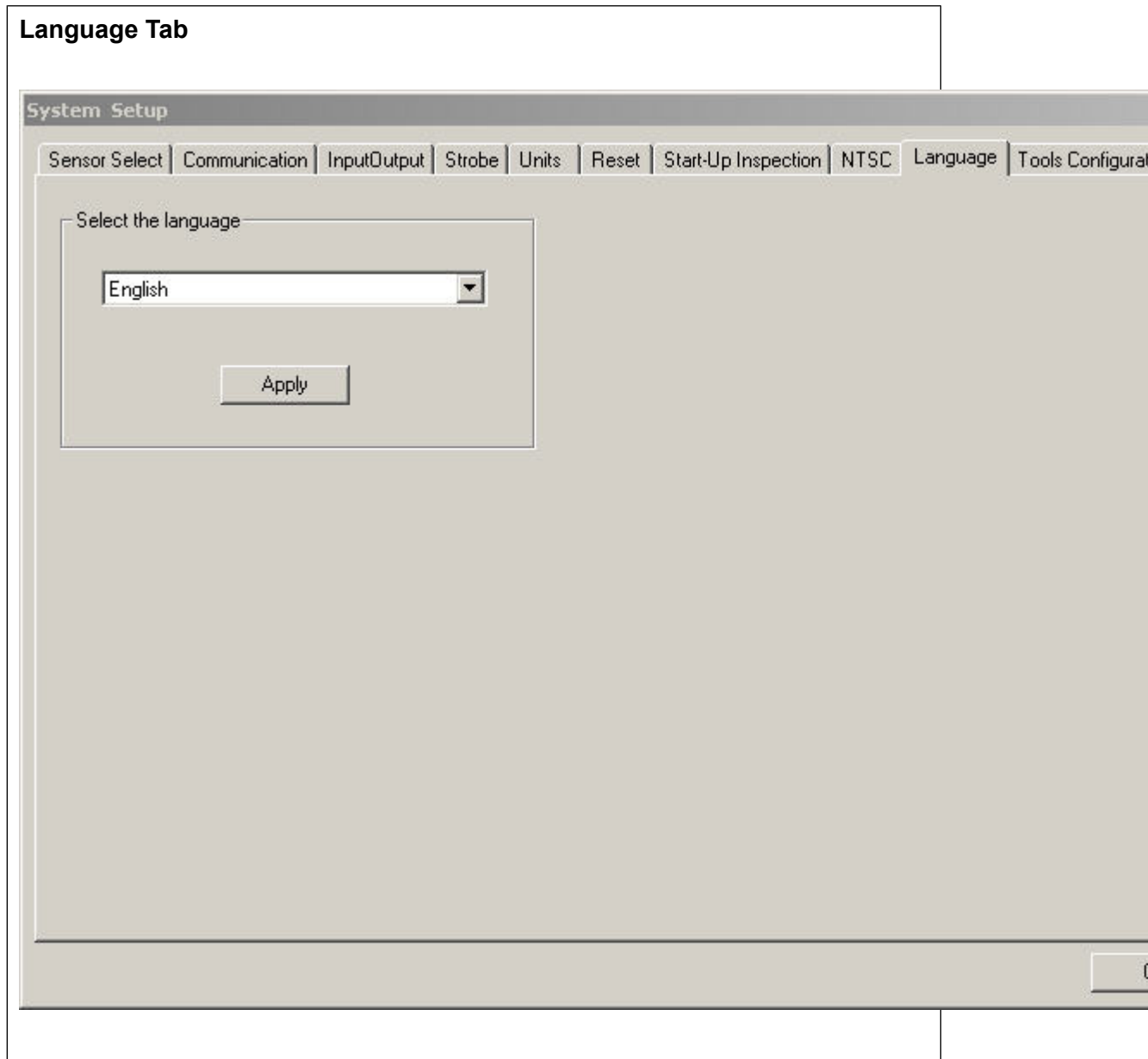

## 6.10 Tools Configuration

Tool Configuration provides the ability to customize the Tools page within the PresencePLUS software. Entire tools, or their enhanced features, can optionally be displayed or hidden. This provides the ability to configure the system to better support your application, thus further simplifying the creation and modification of inspections.

To assist with the customization, the list of tools for the connected sensor is displayed in a tree view. In this tree view, all tools which have a check mark are available for use in the inspection, and all tools that are unchecked are hidden. Similarly, a tool's enhanced feature will be available if checked, and unavailable if unchecked.

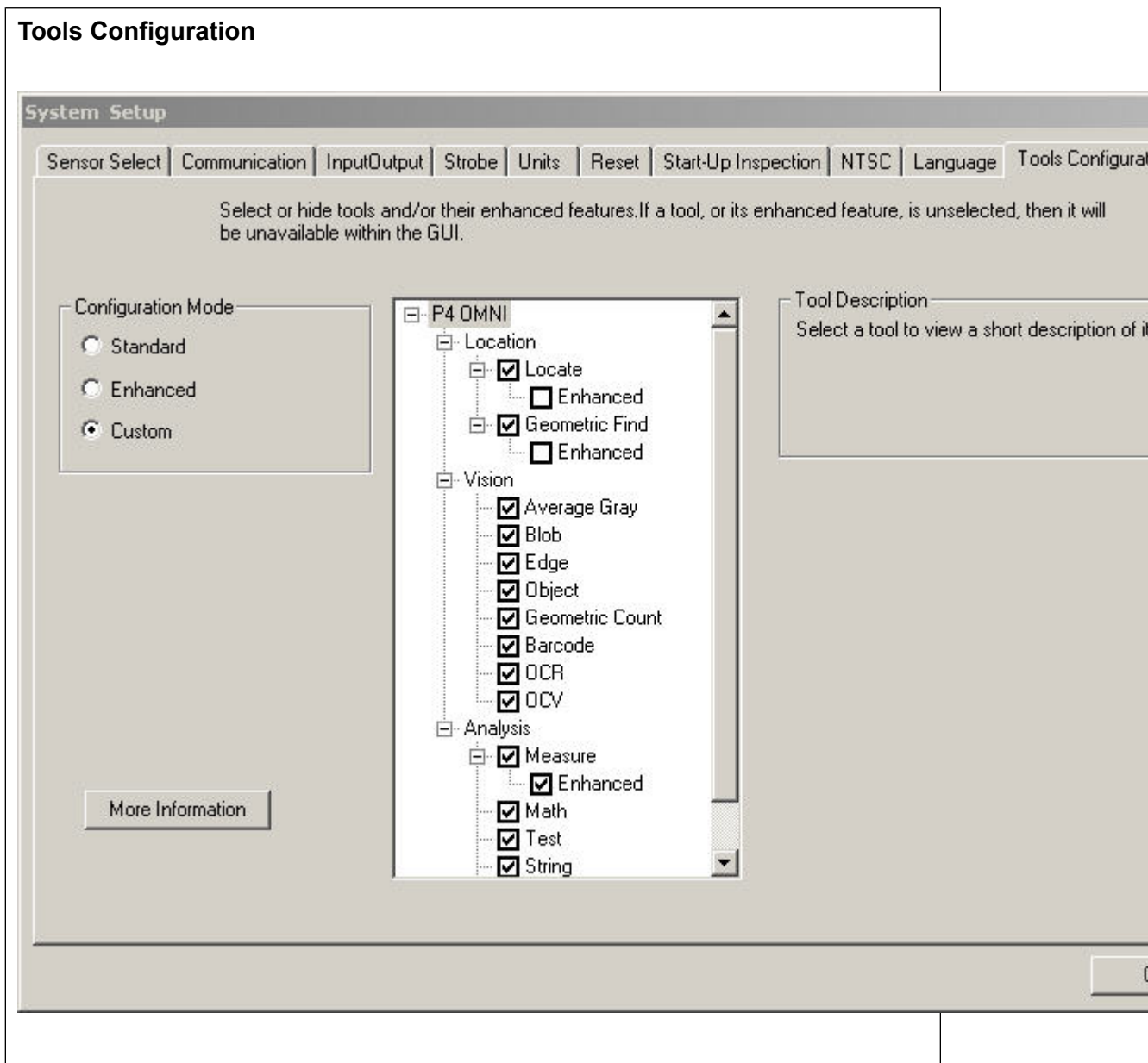

---

### 6.10.1 Standard Mode

Choose this option to reset all tool configuration settings for the connected sensor to the factory defaults.

### 6.10.2 Enhanced Mode

Choose this option to enable all tools and all tool's enhanced features for the connected sensor.

### 6.10.3 Custom Mode

Choose this mode to customize the tools configuration settings within the tree view. This mode is automatically selected when changes are made to the tree view.

The Tool Configuration settings will only affect the sensor that the PresencePLUS software is connected - these settings are stored with the sensor. Therefore, if the PresencePLUS software connects to a different sensor, then that sensor's tool configuration will be reflected within the *PresencePLUS* software.

This feature is available when connected to sensors with 2008R1 or newer versions of firmware.

### 6.10.4 Tool Licensing

Some tools (e.g., barcode and OCR/OCV) require a license to be registered within the sensor before they can be activated. To purchase a license key, contact Banner with the following information:

- MAC address of the sensor you wish to license
- Product Type of the sensor
- The tool(s) you wish to purchase licenses
- Your company information
- An e-mail address to receive the Key

Please use caution when providing this information, as a license issued for one sensor cannot be registered on a different sensor.

After receiving a license key, you may register the license key using two different methods:

#### Method 1 - Use the Firmware Updater (recommended)

- Run the Firmware Updater - version 2.0.4 (2008R1) or newer
- Select the 'Licensing' tab
- Connect to the sensor with the MAC address used for key
- Enter the license key received for the sensor - or browse for the license file
- Click on the 'Register' button
- If necessary, select the 'Update' tab and update the firmware to the latest version

#### Method 2 - Use the PresencePLUS GUI software

(Use this method if sensor has latest version of firmware)

- Start the PresencePLUS software - version 3.2.0 (2008R1) or newer
- Connect to the sensor with the MAC address used for key
- Click 'System' on the title bar and then select the 'Tool Configuration' tab

- Select the tool to activate
- Enter the license key received for the sensor
- Click on the 'Register' button

To view licenses currently registered within the sensor, click the 'Help' button on the title bar and select 'About' from the menu. The licenses are also displayed next to the product name in the title bar.



# PresencePLUS Software Tools

## 7.1 ROI Types

ROI types include Area, Search, and Linear.

### 7.1.1 Linear ROI

Linear ROIs are used by tools that scan along a defined line in a defined direction. Data are averaged along a linear ROI wider than 1 pixel to provide accurate test results. You can adjust the ROI width in increments of 4; that is, 1, 5, 9, 13, and so on. The ROI is widened symmetrically.

 **Note:** Widening an ROI provides an average value/location, which results in improved repeatability.

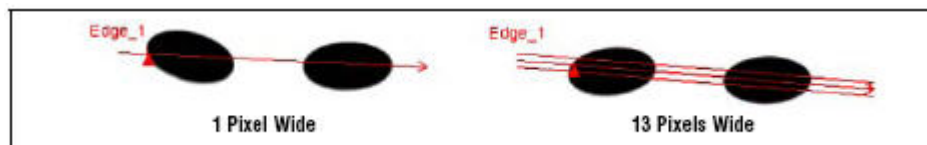

### 7.1.2 Area ROI

An Area ROI can be rectangular, elliptical, or circular. Click on Draw ROI in the input tab to expand the list of ROI shapes from which to select. The shapes are shown below.

 **Note:** An Area ROI can be as large as the entire Field of View (FOV).

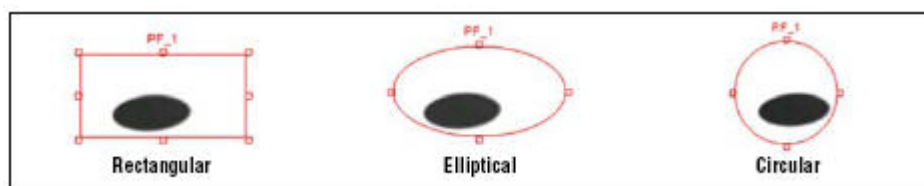

### 7.1.3 Search ROI

Geometric Find, Geometric Count, Pattern Find, and Pattern Count ROIs, like Area ROIs, can be rectangular, elliptical, or circular; however, these ROIs are also bounded by a Search ROI. The Search ROI is indicated by a yellow box that is always rectangular and, by default, is 20% to 30% larger than the Area ROI, which is red.

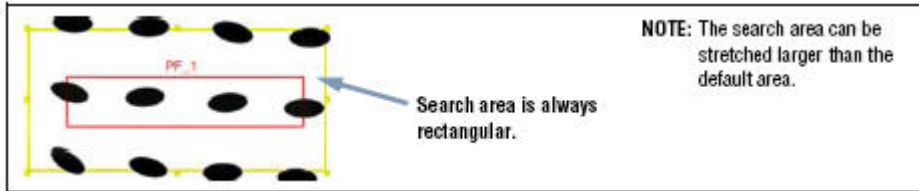

## 7.2 Location Tools

### 7.2.1 Locate Tool

The Locate tool locates the position of a target in a field of view. This tool finds and marks position of the first edge along the ROI line. Typically, tools, including additional Locate tools that follow, are relative to this point. Additionally, the software can calculate the angle at which the Locate tool intersects the feature's edge and rotates following tools Regions of Interest (ROIs) accordingly.

#### Usage

The Locate tool is used to align and position Vision tools consistently over the feature of interest.

#### Fields

The following are fields on the Locate tool Input tab:

- [Threshold Type](#) [7.2.1.2 Threshold Type](#) on page 113
- [Filters](#) [7.2.1.3 Filters](#) on page 118
- [Results](#) [7.2.1.4 Results](#) on page 101
- [Select](#) [7.2.1.5 Select](#) on page 101

#### Supported Platforms

ProII Color	ProII/ProII 1.3	OMNI Color	OMNI/OMNI 1.3	AREA/AREA13	EDGE/EDGE 1.3	GEO/GEO 1.3	BCR/BCR 1.3
Yes	Yes	Yes	Yes	Yes	Yes	Yes	Yes

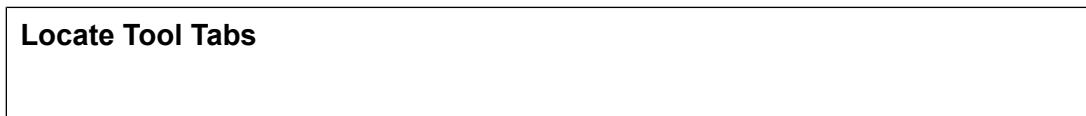



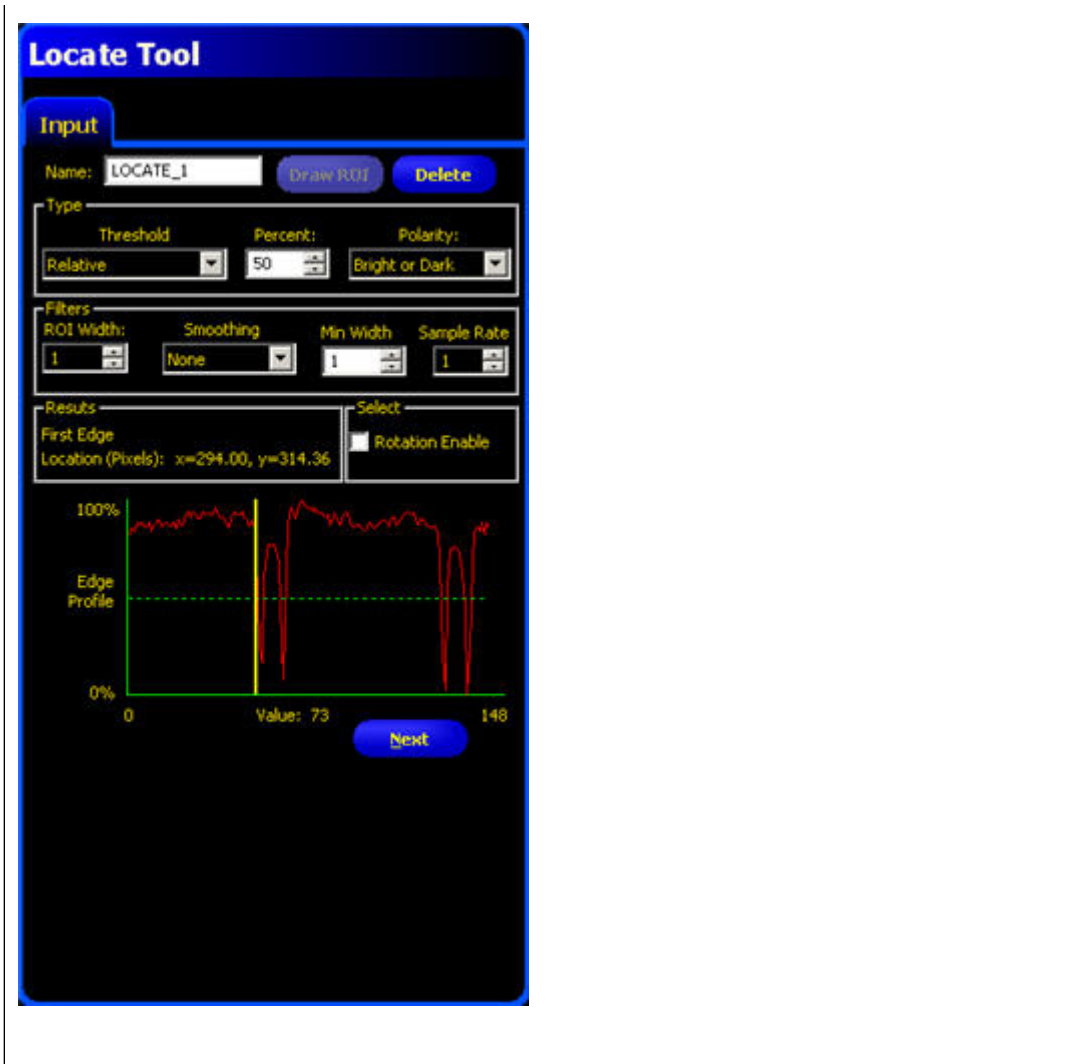

### Adding a Locate Tool

To add a Locate tool to an inspection:

1. Click the button of the tool to be added to the inspection.
2. If desired, rename the tool.
3. Draw an ROI.

Field/Button	Description
Name: <input type="text" value="tool_name_1"/>	Use this field to rename the tool. The default is <i>tool_name_1</i> , <i>tool_name_2</i> , and so on, where the default <i>tool_name</i> depends on the tool being created (for example, locate, edge or the like). The name can have only alphanumeric characters and underscores with no spaces.
<input type="button" value="Draw ROI"/>	Click this button to add an ROI to an image.
<input type="button" value="Delete"/>	Click this button to remove an ROI from an image.

### Threshold Type

The threshold is used to mark the gray scale transition point. The tool marks the edge when the pixel intensity crosses the threshold level. From the dropdown list, select one of the following:

- Relative
- Absolute
- Edge Strength

### Relative Threshold

Relative threshold is the default, and it finds an edge at a relative pixel intensity. The brightest gray scale level is 100% and the darkest is 0%. While Relative threshold is more tolerant of light fluctuations between inspections than other transition types, it may find false edges.



Field/Graph	Description
<b>Percent</b>	Percent is displayed when the Type is Relative. Choose the percentage value at which the edge should be marked.
<b>Polarity</b>	<ul style="list-style-type: none"> <li>• <b>Bright to Dark</b> finds edges that start above the threshold value and cross below the threshold value.</li> <li>• <b>Dark to Bright</b> finds edges that start below the threshold value and cross above the threshold value.</li> <li>• <b>Bright or Dark</b> finds any edge.</li> </ul>
<b>Edge Profile Graph</b>	<p>In the Edge Profile graph displayed when the Relative threshold is selected, the red line shows the percentage pixel intensity relative to the green threshold line. The threshold line will move up or down with the percent value.</p> <p>The graph shows a red line representing pixel intensity and a green dashed line representing the threshold. The y-axis is labeled from 0% to 100%. The x-axis is labeled 'Value' with a value of 424. The red line shows a sharp dip at the threshold level.</p>

### Absolute Threshold

Absolute threshold finds an edge at a specific gray scale level. While Absolute threshold is less likely to find a false edge than Relative Threshold, it may miss edges if the light level changes between inspections.



Field/Graph	Description
<b>Value</b>	Value is displayed when Type is Absolute. Enter a specific gray scale value from 0 to 255.
<b>Polarity</b>	<ul style="list-style-type: none"> <li>• <b>Bright to Dark</b> finds edges that start above the threshold value and cross below the threshold value.</li> <li>• <b>Dark to Bright</b> finds edges that start below the threshold value and cross above the threshold value.</li> <li>• <b>Bright or Dark</b> finds any edge.</li> </ul>
<b>Edge Profile Graph</b>	<p>In the Edge Profile graph displayed when the Absolute threshold is selected, the red line shows the percentage pixel intensity relative to the green threshold line. The threshold line will move up or down with the percent value.</p>

### Edge Strength

Edge strength measures the rate of change of grayscale values and needs sharply-defined transitions. Edge strength is more tolerant of gradual changes in light levels across the tool than other transition types and it will filter out weak or gradual edges.



Field	Description
<b>Edge</b>	Enter an edge bandwidth value from 1 to 255.
<b>Polarity</b>	<ul style="list-style-type: none"> <li>• <b>Bright to Dark</b> finds edges that start above the threshold value and cross below the threshold value.</li> <li>• <b>Dark to Bright</b> finds edges that start below the threshold value and cross above the threshold value.</li> </ul>

Field	Description
	<ul style="list-style-type: none"> <li>• <b>Bright or Dark</b> finds any edge.</li> </ul>

**Graph Tab**

When Edge Strength is selected in the Input tab, the software displays the Graph tab. This tab provides similar information to the Input tab, but displays separate Edge Profile and Edge Strength graphs for easier viewing.

The Edge Profile graph represents the absolute gray scale level across the tool ROI.

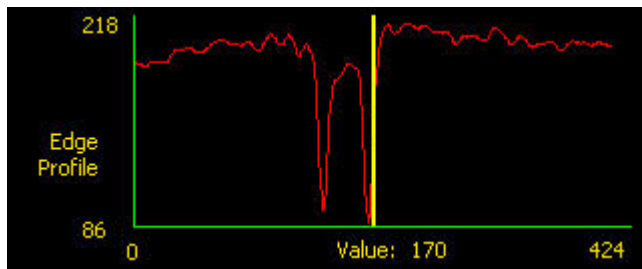

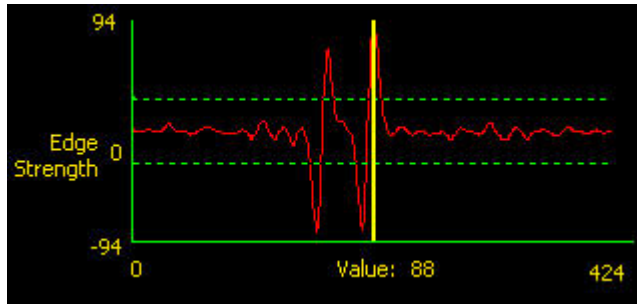

The Edge Strength graph represents the change in gray scale along the tool ROI. Edge Strength detects an edge when the rate of change (solid red line on the graph) crosses the selected intensity change amount (dashed green lines on the screen).



A bright-to-dark transition has a negative edge strength value, and a dark-to-bright transition has a positive edge strength value. When the Edge Strength level is adjusted, both the negative and positive green dotted lines will adjust together.

**Filters**



Field	Description
ROI Width	Increases in increments of 4 pixels (for example, 1, 5, 9, 13, ...) up to the total FOV size. Some things to note: <ul style="list-style-type: none"> <li>• Narrow ROIs execute faster but could miss the edge.</li> <li>• Wide ROIs are more consistent but don't execute as fast.</li> <li>• The ROI must be 13 pixels or wider to calculate the rotation of a part.</li> </ul>
Smoothing	Runs a rolling average along the ROI length. It filters out sharp changes in the edge profile. <p> <b>Note:</b> A high filter number may miss the edge of a narrow line.</p>
Min Width	Filters out small spike-of-intensity changes, and narrow dark or bright bands. It determines the distance (in pixels) before and after an edge that must be free from additional transitions or the end of the ROI before the edge is recognized. <p> <b>Note:</b> A high filter number may miss the edge of a narrow line.</p>
Sample Rate	Determines the sub-pixel resolution, which increases the resolution of the tool, and increases the inspection time. <ol style="list-style-type: none"> <li>1. 1-pixel resolution</li> <li>2. 1/2-pixel resolution</li> <li>3. 1/3-pixel resolution</li> <li>4. 1/4-pixel resolution</li> </ol>

## Results



The Results field provides the position of the first edge found. The position is expressed as X, Y coordinates in pixels, with the origin (0,0) at the upper-left corner of the screen.

## Select



If you select Rotation Enable, the software Activates the rotation compensation calculation. ROIs that follow will rotate according to the difference between the reference image and the current inspection image.

 **Note:** ROI width must be 13 pixels or greater.

### Advanced Tab

If you have enabled the Advanced Configuration in the System setup, the software displays and Advanced tab. This enables you to force any location tool to Absolute Positioning.



### Graph Tab

When Edge Strength is selected, the Graph tab appears on the tool window. The graph for the Input tab overlays both the edge strength graph and the edge profile. In the Graph tab, the edge profile graph and the edge strength graph are separated for easier viewing.

The top graph, Edge Profile, represents the absolute gray scale level across the Edge tool.

The bottom graph, Edge Strength, represents the change in gray scale along the Edge tool.

Edge Strength detects an edge when the rate of change (solid red line on the screen) crosses the selected intensity change amount (dashed green lines on the screen).

A bright-to-dark transition has a negative edge strength value, and a dark-to-bright transition has a positive edge strength value. When the Edge Strength level is adjusted, both the negative and positive lines will adjust together.

### Graph Tab

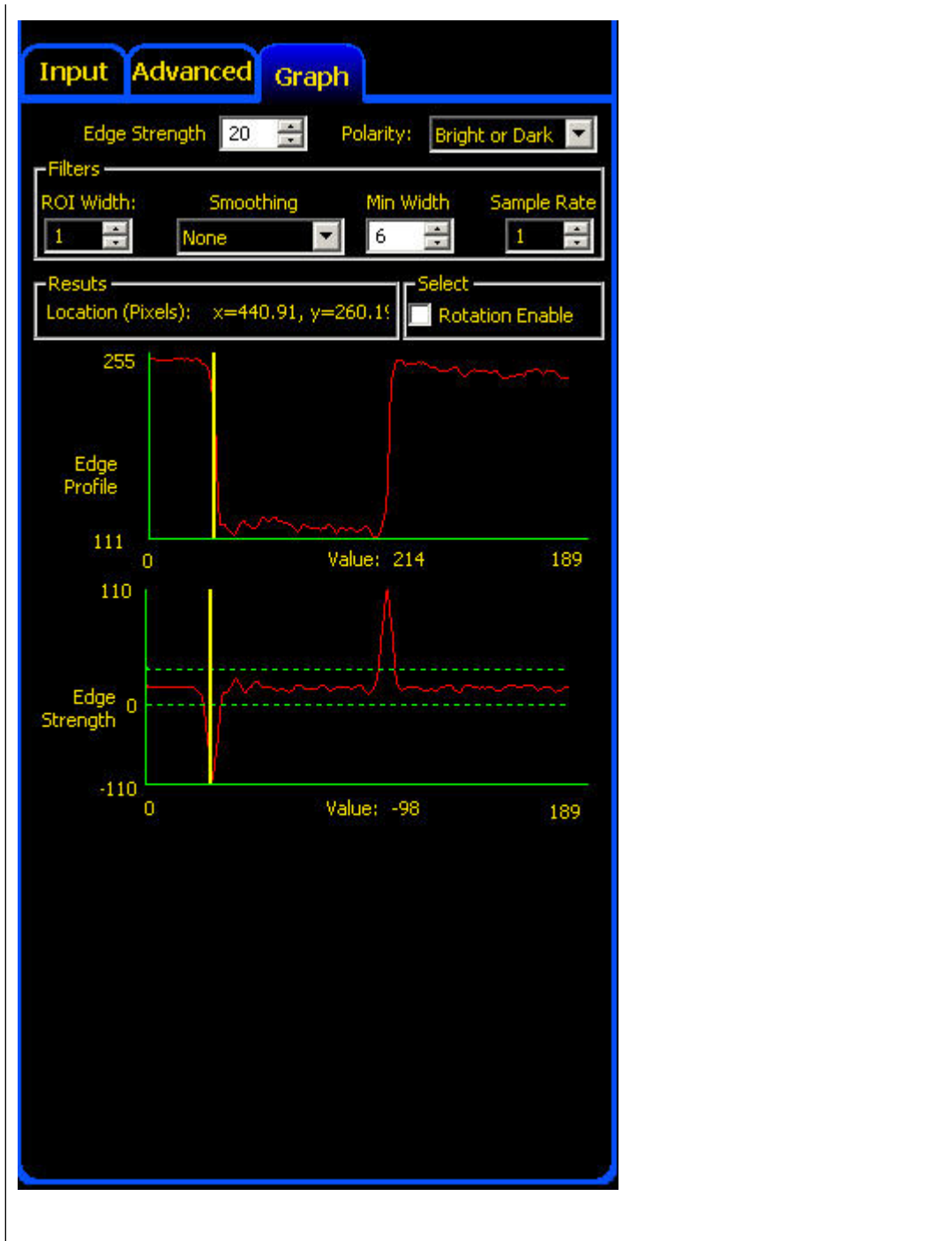

### 7.3 Vision Gray Scale Tools

Vision tools analyze an image and extract information used for judgment criteria.

### 7.3.1 Edge Tool

The Edge tool finds and marks the position of all edges along an *ROI* line. It detects and counts transitions between bright and dark pixels. The total number of edges can be counted, and the position of each edge can be found. Edge position information can be used for distance or angle measurement.

**Usage**

- Measure the height and width of a part
- Count the pins on a resistor
- Measure the height of a needle
- Measure the deflection of an automotive gauge
- Detect the edge of a web
- Verify that a bottle cap is on completely

**Fields**

The following are fields on the Edge tool Input tab:

- [Threshold Type](#)[7.2.1.2 Threshold Type](#) on page 113
- [Filters](#)[7.2.1.3 Filters](#) on page 118
- [Edge Tool Results](#)[7.3.1.4 Edge Tool Results](#) on page 109

**Supported Platforms**

ProII Color	ProII/ProII 1.3	OMNI Color	OMNI/OMNI 1.3	AREA/AREA13	EDGE/EDGE 1.3	GEO/GEO 1.3	BCR/BCR 1.3
Yes	Yes	Yes	Yes	No	Yes	No	No





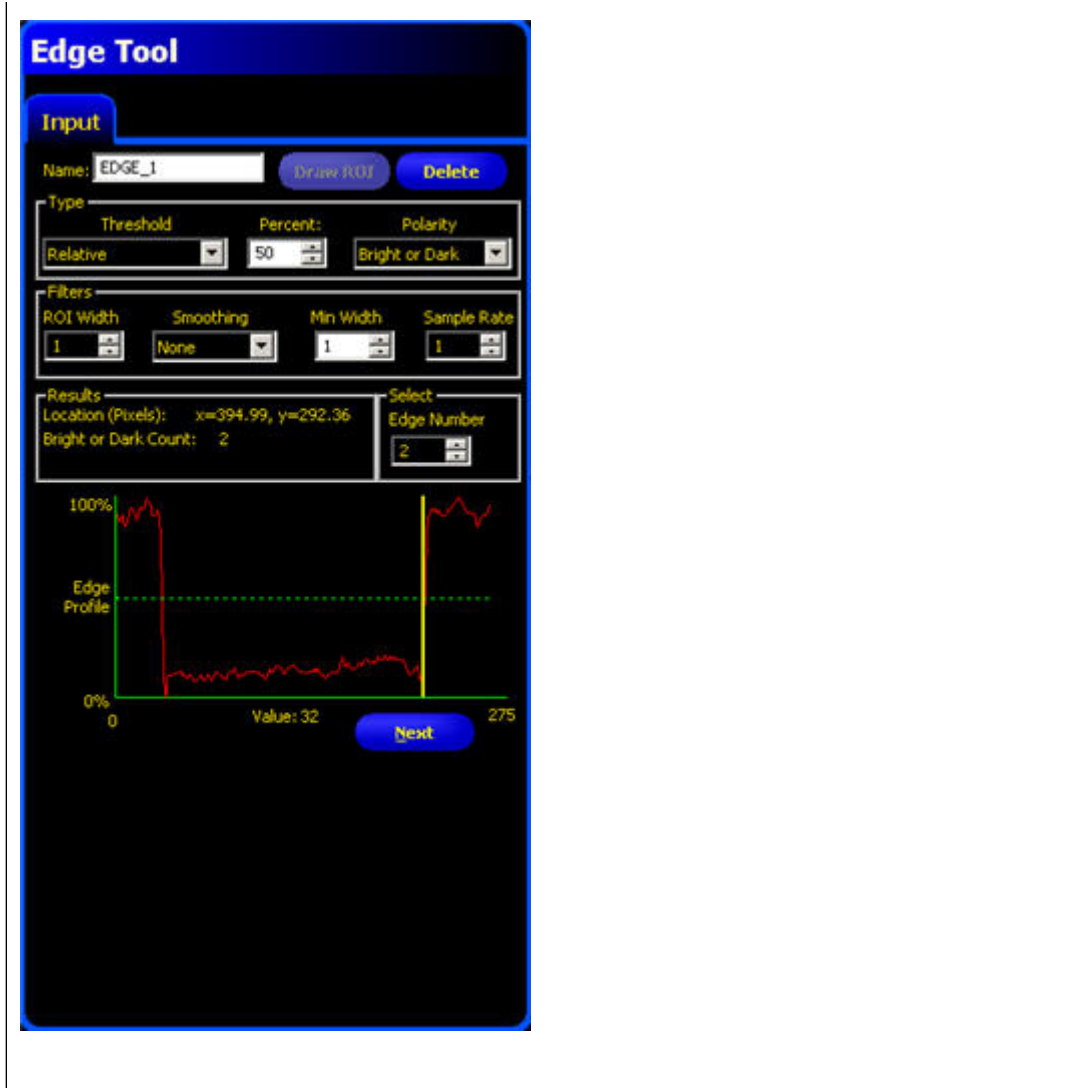

## Adding an Edge Tool

### Threshold Type

The threshold is used to mark the gray scale transition point. The tool marks the edge when the pixel intensity crosses the threshold level. From the dropdown list, select one of the following:

- Relative
- Absolute
- Edge Strength

### Relative Threshold

Relative threshold is the default, and it finds an edge at a relative pixel intensity. The brightest gray scale level is 100% and the darkest is 0%. While Relative threshold is more tolerant of light fluctuations between inspections than other transition types, it may find false edges.



Field/Graph	Description
<b>Percent</b>	Percent is displayed when the Type is Relative. Choose the percentage value at which the edge should be marked.
<b>Polarity</b>	<ul style="list-style-type: none"> <li>• <b>Bright to Dark</b> finds edges that start above the threshold value and cross below the threshold value.</li> <li>• <b>Dark to Bright</b> finds edges that start below the threshold value and cross above the threshold value.</li> <li>• <b>Bright or Dark</b> finds any edge.</li> </ul>
<b>Edge Profile Graph</b>	<p>In the Edge Profile graph displayed when the Relative threshold is selected, the red line shows the percentage pixel intensity relative to the green threshold line. The threshold line will move up or down with the percent value.</p> <p>The graph shows a red line representing pixel intensity and a green dashed line representing the threshold. The y-axis is labeled 'Edge Profile' with '0%' at the bottom and '100%' at the top. The x-axis is labeled 'Value' with '0' on the left and '424' on the right.</p>

### Absolute Threshold

Absolute threshold finds an edge at a specific gray scale level. While Absolute threshold is less likely to find a false edge than Relative Threshold, it may miss edges if the light level changes between inspections.



Field/Graph	Description
<b>Value</b>	Value is displayed when Type is Absolute. Enter a specific gray scale value from 0 to 255.
<b>Polarity</b>	<ul style="list-style-type: none"> <li>• <b>Bright to Dark</b> finds edges that start above the threshold value and cross below the threshold value.</li> <li>• <b>Dark to Bright</b> finds edges that start below the threshold value and cross above the threshold value.</li> </ul>

Field/Graph	Description
	<ul style="list-style-type: none"> <li>• <b>Bright or Dark</b> finds any edge.</li> </ul>
<b>Edge Profile Graph</b>	<p>In the Edge Profile graph displayed when the Absolute threshold is selected, the red line shows the percentage pixel intensity relative to the green threshold line. The threshold line will move up or down with the percent value.</p> 

### Edge Strength

Edge strength measures the rate of change of grayscale values and needs sharply-defined transitions. Edge strength is more tolerant of gradual changes in light levels across the tool than other transition types and it will filter out weak or gradual edges.



Field	Description
<b>Edge</b>	Enter an edge bandwidth value from 1 to 255.
<b>Polarity</b>	<ul style="list-style-type: none"> <li>• <b>Bright to Dark</b> finds edges that start above the threshold value and cross below the threshold value.</li> <li>• <b>Dark to Bright</b> finds edges that start below the threshold value and cross above the threshold value.</li> <li>• <b>Bright or Dark</b> finds any edge.</li> </ul>

### Graph Tab

When Edge Strength is selected in the Input tab, the software displays the Graph tab. This tab provides similar information to the Input tab, but displays separate Edge Profile and Edge Strength graphs for easier viewing.

The Edge Profile graph represents the absolute gray scale level across the tool ROI.

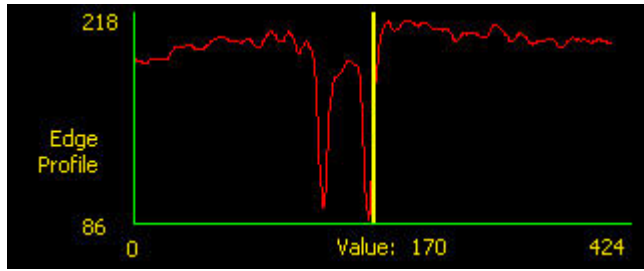

The Edge Strength graph represents the change in gray scale along the tool ROI. Edge Strength detects an edge when the rate of change (solid red line on the graph) crosses the selected intensity change amount (dashed green lines on the screen).

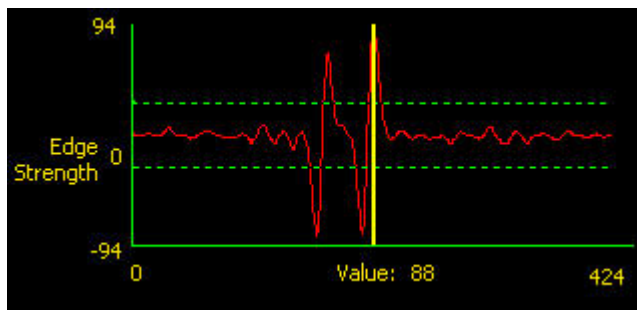

A bright-to-dark transition has a negative edge strength value, and a dark-to-bright transition has a positive edge strength value. When the Edge Strength level is adjusted, both the negative and positive green dotted lines will adjust together.

**Filters**



Field	Description
<b>ROI Width</b>	Increases in increments of 4 pixels (for example, 1, 5, 9, 13, ...) up to the total FOV size. Some things to note: <ul style="list-style-type: none"> <li>• Narrow ROIs execute faster but could miss the edge.</li> <li>• Wide ROIs are more consistent but don't execute as fast.</li> <li>• The ROI must be 13 pixels or wider to calculate the rotation of a part.</li> </ul>
<b>Smoothing</b>	Runs a rolling average along the ROI length. It filters out sharp changes in the edge profile. <p><b>Note:</b> A high filter number may miss the edge of a narrow line.</p>

Field	Description
<b>Min Width</b>	Filters out small spike-of-intensity changes, and narrow dark or bright bands. It determines the distance (in pixels) before and after an edge that must be free from additional transitions or the end of the ROI before the edge is recognized.   <b>Note:</b> A high filter number may miss the edge of a narrow line.
<b>Sample Rate</b>	Determines the sub-pixel resolution, which increases the resolution of the tool, and increases the inspection time.  <ol style="list-style-type: none"> <li>1-pixel resolution</li> <li>1/2-pixel resolution</li> <li>1/3-pixel resolution</li> <li>1/4-pixel resolution</li> </ol>

## Edge Tool Results

The Results field returns the following:

- X,Y coordinates of the current edge. The origin (0,0) is the upper-left corner of the screen.
- A **Edge Number** field for selecting an edge to analyze.
- Total number of bright-to-dark and dark-to-bright edges, depending on the **Polarity** option in effect.



## Graph Tab

When Edge Strength is selected, the Graph tab appears on the tool window. The graph for the Input tab overlays both the edge strength graph and the edge profile. In the Graph tab, the edge profile graph and the edge strength graph are separated for easier viewing.

The top graph, Edge Profile, represents the absolute gray scale level across the Edge tool.

The bottom graph, Edge Strength, represents the change in gray scale along the Edge tool.

Edge Strength detects an edge when the rate of change (solid red line on the screen) crosses the selected intensity change amount (dashed green lines on the screen).

A bright-to-dark transition has a negative edge strength value, and a dark-to-bright transition has a positive edge strength value. When the Edge Strength level is adjusted, both the negative and positive lines will adjust together.

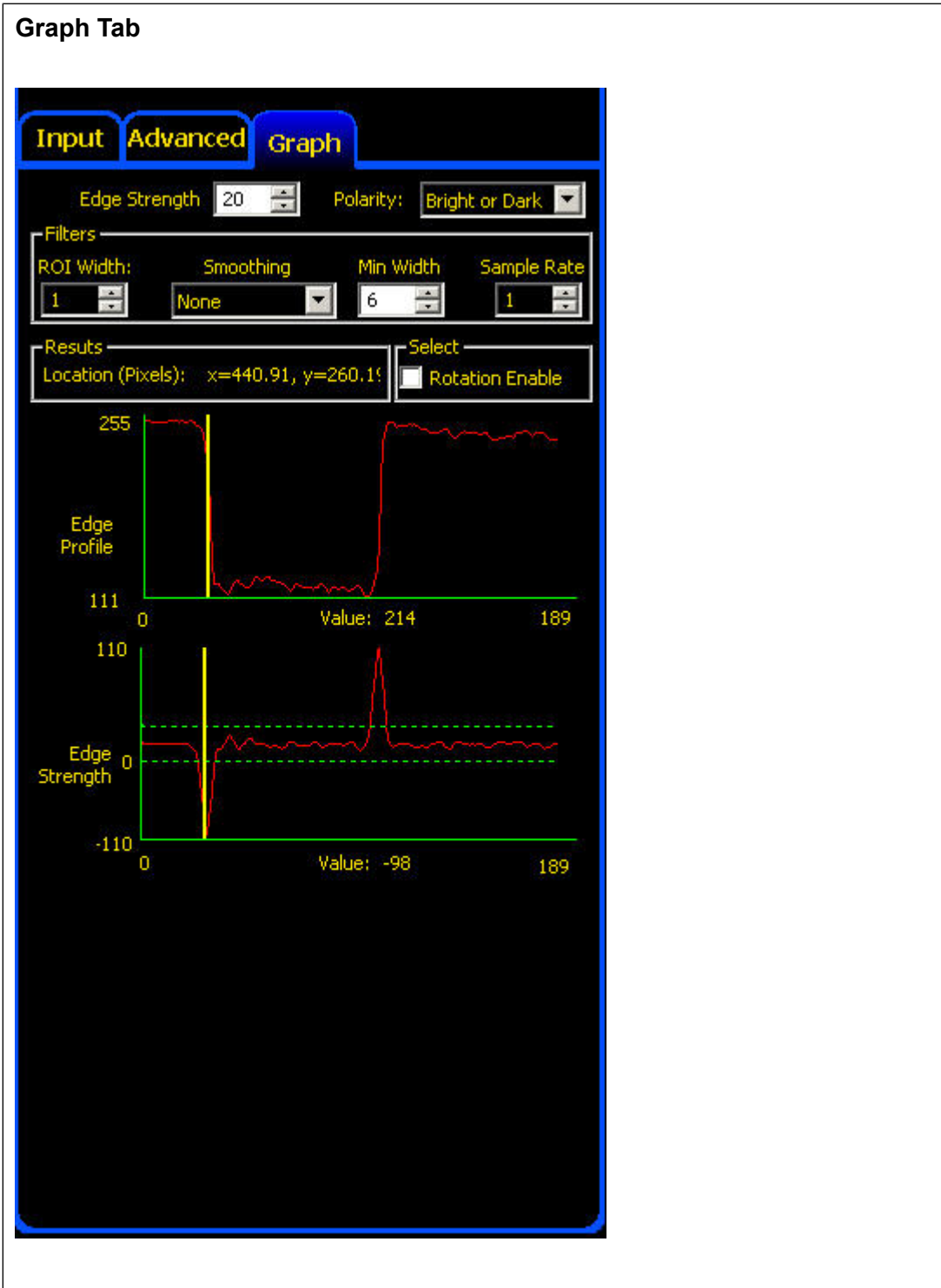

## 7.3.2 Object Tool

The Object tool detects the edges of dark and bright segments in an ROI. The Object tool measures the widths of every dark and light segment along the ROI. The Object tool calculates the midpoint for every object, and counts the total number of objects. The midpoint can be used to measure distances and angles. Each object can have unique size limit, or all objects may have the same size limit.

### Usage

- Measure the width of a label
- Locate the center of a box on a conveyor
- Measure the gaps between stamped parts on a Web.

### Fields

The following are fields on the Object tool Input tab:

- [Threshold Type](#) [7.2.1.2 Threshold Type](#) on page 113
- [Filters](#) [7.2.1.3 Filters](#) on page 118
- [Object Tool Results](#) [7.3.2.4 Object Tool Results](#) on page 119

### Supported Platforms

ProII Color	ProII/ProII 1.3	OMNI Color	OMNI/OMNI 1.3	AREA/AREA13	EDGE/EDGE 1.3	GEO/GEO 1.3	BCR/BCR 1.3
Yes	Yes	Yes	Yes	No	Yes	No	No

**Object Tool Input Tab**

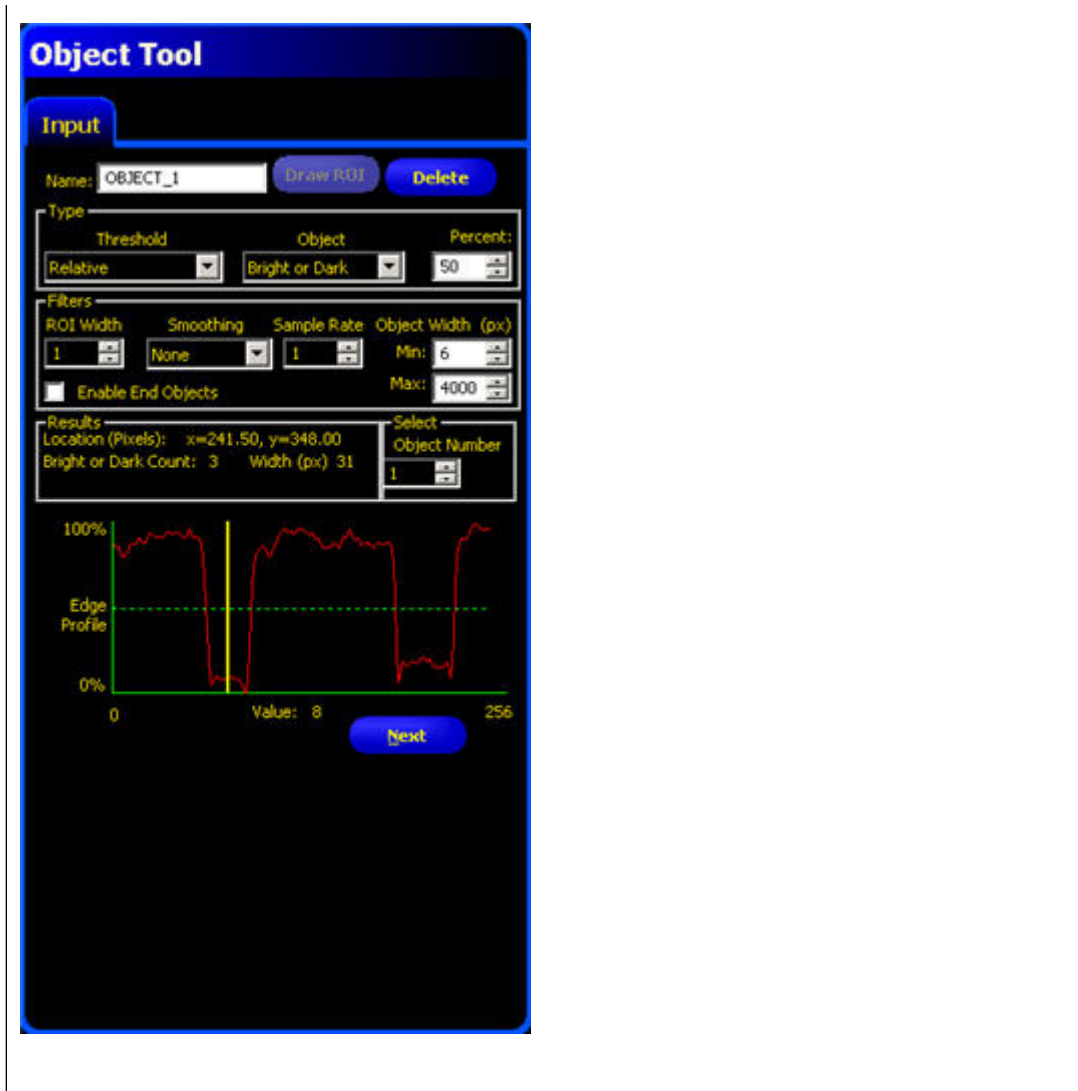

### Adding a Linear Tool

To add a tool to an inspection:

Field/Button	Description
Name: <input type="text" value="tool_name_1"/>	Use this field to rename the tool. The default is <i>tool_name_1</i> , <i>tool_name_2</i> , and so on, where the default <i>tool_name</i> depends on the tool being created (for example, locate, edge or the like). The name can have only alphanumeric characters and underscores with no spaces.
<input type="button" value="Draw ROI"/>	Click this button to add an ROI to an image.
<input type="button" value="Delete"/>	Click this button to remove an ROI from an image.



## Threshold Type

The threshold is used to mark the gray scale transition point. The tool marks the edge when the pixel intensity crosses the threshold level. From the dropdown list, select one of the following:

- Relative
- Absolute
- Edge Strength

### Relative Threshold

Relative threshold is the default, and it finds an edge at a relative pixel intensity. The brightest gray scale level is 100% and the darkest is 0%. While Relative threshold is more tolerant of light fluctuations between inspections than other transition types, it may find false edges.



Field/Graph	Description
<b>Percent</b>	Percent is displayed when the Type is Relative. Choose the percentage value at which the edge should be marked.
<b>Polarity</b>	<ul style="list-style-type: none"> <li>• <b>Bright to Dark</b> finds edges that start above the threshold value and cross below the threshold value.</li> <li>• <b>Dark to Bright</b> finds edges that start below the threshold value and cross above the threshold value.</li> <li>• <b>Bright or Dark</b> finds any edge.</li> </ul>
<b>Edge Profile Graph</b>	<p>In the Edge Profile graph displayed when the Relative threshold is selected, the red line shows the percentage pixel intensity relative to the green threshold line. The threshold line will move up or down with the percent value.</p>

### Absolute Threshold

Absolute threshold finds an edge at a specific gray scale level. While Absolute threshold is less likely to find a false edge than Relative Threshold, it may miss edges if the light level changes between inspections.



Field/Graph	Description
<b>Value</b>	Value is displayed when Type is Absolute. Enter a specific gray scale value from 0 to 255.
<b>Polarity</b>	<ul style="list-style-type: none"> <li>• <b>Bright to Dark</b> finds edges that start above the threshold value and cross below the threshold value.</li> <li>• <b>Dark to Bright</b> finds edges that start below the threshold value and cross above the threshold value.</li> <li>• <b>Bright or Dark</b> finds any edge.</li> </ul>
<b>Edge Profile Graph</b>	<p>In the Edge Profile graph displayed when the Absolute threshold is selected, the red line shows the percentage pixel intensity relative to the green threshold line. The threshold line will move up or down with the percent value.</p>

### Edge Strength

Edge strength measures the rate of change of grayscale values and needs sharply-defined transitions. Edge strength is more tolerant of gradual changes in light levels across the tool than other transition types and it will filter out weak or gradual edges.



Field	Description
<b>Edge</b>	Enter an edge bandwidth value from 1 to 255.
<b>Polarity</b>	<ul style="list-style-type: none"> <li>• <b>Bright to Dark</b> finds edges that start above the threshold value and cross below the threshold value.</li> <li>• <b>Dark to Bright</b> finds edges that start below the threshold value and cross above the threshold value.</li> </ul>

Field	Description
	<ul style="list-style-type: none"> <li>• <b>Bright or Dark</b> finds any edge.</li> </ul>

### Graph Tab

When Edge Strength is selected in the Input tab, the software displays the Graph tab. This tab provides similar information to the Input tab, but displays separate Edge Profile and Edge Strength graphs for easier viewing.

The Edge Profile graph represents the absolute gray scale level across the tool ROI.

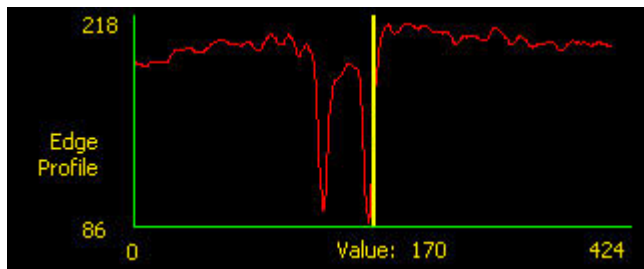

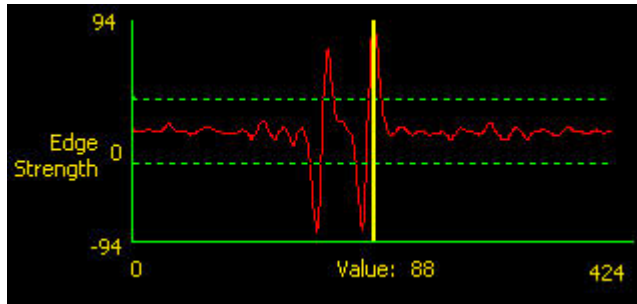

The Edge Strength graph represents the change in gray scale along the tool ROI. Edge Strength detects an edge when the rate of change (solid red line on the graph) crosses the selected intensity change amount (dashed green lines on the screen).



A bright-to-dark transition has a negative edge strength value, and a dark-to-bright transition has a positive edge strength value. When the Edge Strength level is adjusted, both the negative and positive green dotted lines will adjust together.

### Filters



Field	Description
<b>ROI Width</b>	Increases in increments of 4 pixels (for example, 1, 5, 9, 13, ...) up to the total FOV size. Some things to note: <ul style="list-style-type: none"> <li>• Narrow ROIs execute faster but could miss the edge.</li> <li>• Wide ROIs are more consistent but don't execute as fast.</li> <li>• The ROI must be 13 pixels or wider to calculate the rotation of a part.</li> </ul>
<b>Smoothing</b>	Runs a rolling average along the ROI length. It filters out sharp changes in the edge profile. <p> <b>Note:</b> A high filter number may miss the edge of a narrow line.</p>
<b>Min Width</b>	Filters out small spike-of-intensity changes, and narrow dark or bright bands. It determines the distance (in pixels) before and after an edge that must be free from additional transitions or the end of the ROI before the edge is recognized. <p> <b>Note:</b> A high filter number may miss the edge of a narrow line.</p>
<b>Sample Rate</b>	Determines the sub-pixel resolution, which increases the resolution of the tool, and increases the inspection time. <ol style="list-style-type: none"> <li>1. 1-pixel resolution</li> <li>2. 1/2-pixel resolution</li> <li>3. 1/3-pixel resolution</li> <li>4. 1/4-pixel resolution</li> </ol>

### Object Width

Object Width filters out objects and spaces that are smaller than the minimum and larger than the maximum values specified.



The minimum and maximum object width affects both objects and spaces between objects. Minimum object width can filter out objects and spaces.

### Object Tool Results

The **Results** field returns the following:

- The position of the object midpoint. The origin (0,0) is the upper-left corner of the screen.
- A Select Object Number field for selecting an object to analyze.
- Total number of Bright, Dark, or All objects (depending on the Bright/Dark option in effect).
- Distance between the edges of the current object.

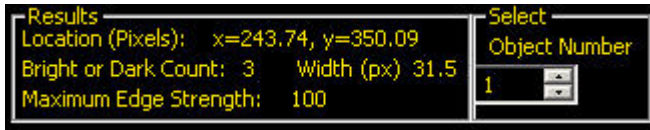

## Graph Tab

When Edge Strength is selected, the Graph tab appears on the tool window. The graph for the Input tab overlays both the edge strength graph and the edge profile. In the Graph tab, the edge profile graph and the edge strength graph are separated for easier viewing.

The top graph, Edge Profile, represents the absolute gray scale level across the Edge tool.

The bottom graph, Edge Strength, represents the change in gray scale along the Edge tool.

Edge Strength detects an edge when the rate of change (solid red line on the screen) crosses the selected intensity change amount (dashed green lines on the screen).

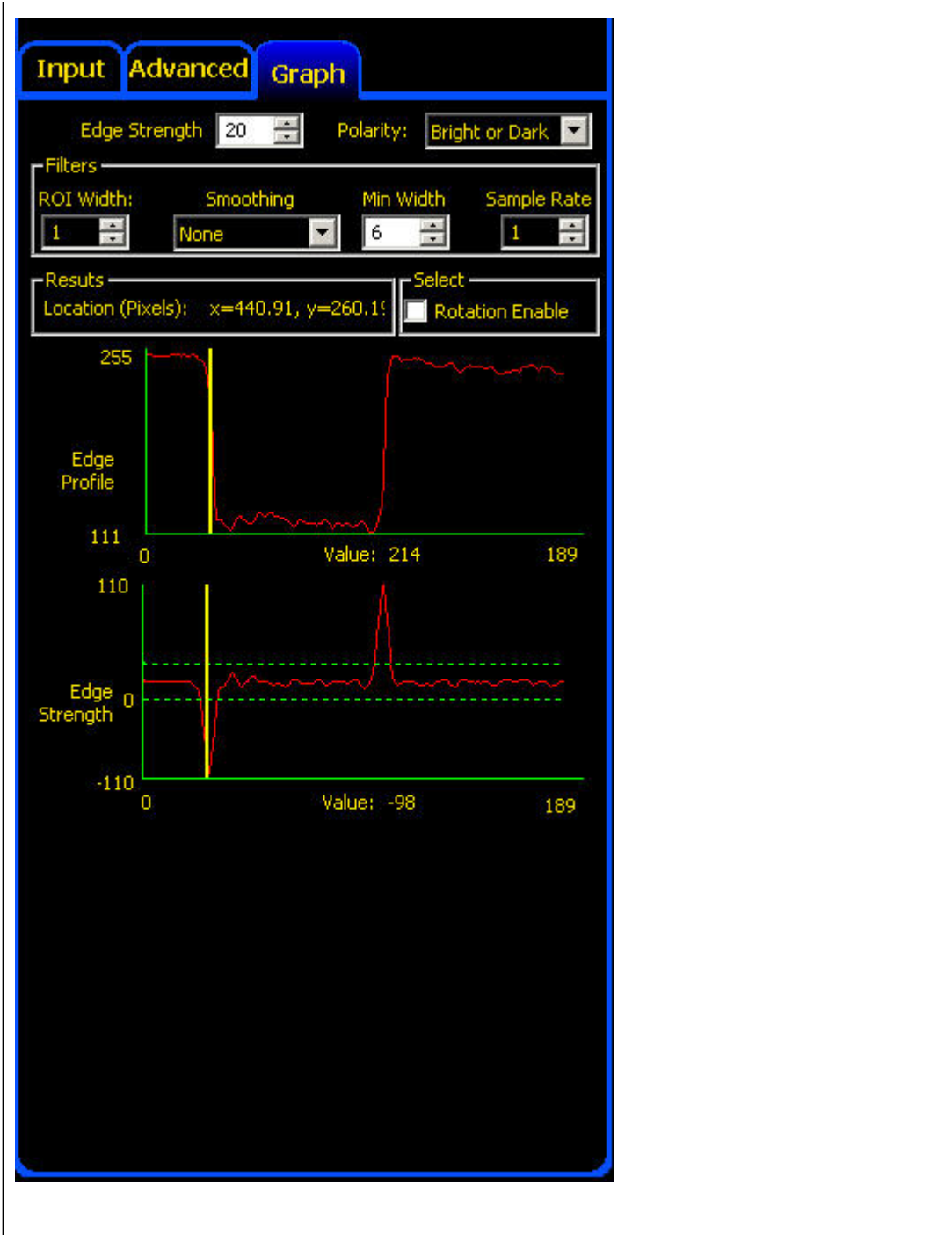

A bright-to-dark transition has a negative edge strength value, and a dark-to-bright transition has a positive edge strength value. When the Edge Strength level is adjusted, both the negative and positive lines will adjust together.

### Graph Tab



**Filters**

A close-up of the 'Filters' control panel showing 'ROI Width' set to 1, 'Smoothing' set to None, 'Min Width' set to 6, and 'Sample Rate' set to 2.

Field	Description
<b>ROI Width</b>	Increases in increments of 4 pixels (for example, 1, 5, 9, 13, ...) up to the total FOV size. Some things to note: <ul style="list-style-type: none"> <li>• Narrow ROIs execute faster but could miss the edge.</li> <li>• Wide ROIs are more consistent but don't execute as fast.</li> <li>• The ROI must be 13 pixels or wider to calculate the rotation of a part.</li> </ul>
<b>Smoothing</b>	Runs a rolling average along the ROI length. It filters out sharp changes in the edge profile. <p> <b>Note:</b> A high filter number may miss the edge of a narrow line.</p>
<b>Min Width</b>	Filters out small spike-of-intensity changes, and narrow dark or bright bands. It determines the distance (in pixels) before and after an edge that must be free from additional transitions or the end of the ROI before the edge is recognized. <p> <b>Note:</b> A high filter number may miss the edge of a narrow line.</p>
<b>Sample Rate</b>	Determines the sub-pixel resolution, which increases the resolution of the tool, and increases the inspection time. <ol style="list-style-type: none"> <li>1. 1-pixel resolution</li> <li>2. 1/2-pixel resolution</li> <li>3. 1/3-pixel resolution</li> <li>4. 1/4-pixel resolution</li> </ol>

### Object Width

Object Width filters out objects and spaces that are smaller than the minimum and larger than the maximum values specified.



The minimum and maximum object width affects both objects and spaces between objects. Minimum object width can filter out objects and spaces.

### Object Tool Results

The **Results** field returns the following:

- The position of the object midpoint. The origin (0,0) is the upper-left corner of the screen.
- A Select Object Number field for selecting an object to analyze.
- Total number of Bright, Dark, or All objects (depending on the Bright/Dark option in effect).
- Distance between the edges of the current object.



## 7.4 Analysis Tools

Analysis tools analyze the information gathered with the Vision tools to create measurements and tolerances for the Vision tools.

### Analysis Tools

Location Tools	ProII Color	ProII/ProII 1.3	OMNI Color	OMNI/OMNI 1.3	AREA/AREA13	EDGE/EDGE 1.3	GEO/GEO 1.3	BCR/BCR 1.3
<a href="#">Coordinate Tool 7.4.2</a> <i>Coordinate Tool on page 137</i>	Yes	Yes	Yes	Yes	No	No	No	No
<a href="#">Communication Tool 7.4.1</a> <i>Communication Tool on page 121</i>	Yes	Yes	Yes	Yes	Yes	Yes	Yes	Yes
<a href="#">Math Tool 7.4.3</a> <i>Math Tool on page 140</i>	Yes	Yes	Yes	Yes	Yes	Yes	Yes	Yes
<a href="#">Measure Tool 7.4.4</a> <i>Measure Tool on page 145</i>	Yes	Yes	Yes	Yes	Yes	Yes	Yes	Yes
<a href="#">#unique_140</a>	Yes	Yes	Yes	Yes	No	No	No	Yes
<a href="#">Test Tool 7.4.5</a> <i>Test Tool on page 166</i>	Yes	Yes	Yes	Yes	Yes	Yes	Yes	Yes



## 7.4.1 Communication Tool

The Communication tool is used to conditionally export data from the Sensor to an external device. Results from Vision tools can be selected by the Communication tool and exported to an external device. The Sensor can export data over the Ethernet or via its serial channels.

### Examples of exported results

- Execution times
- Whole-number counts
- Input and output values from a Test tool
- Success from Locate and Test tools
- Reference point-to-edge and rotation distances

### Fields

The following are fields on the Communication tool Input tab:

- [Select 7.4.1.2 Select](#) on page 123
- [Connections 7.4.1.3 Connections](#) on page 123
- [Format 7.4.1.4 Format](#) on page 123
- [Output Filter 7.4.1.5 Output Filter](#) on page 124
- [Guidelines for Configuring the Communication Tool 7.4.1.6 Guidelines for Configuring the Communication Tool](#) on page 124

### Supported Platforms

Proll Color	Proll/Proll 1.3	OMNI Color	OMNI/OMNI 1.3	AREA/AREA13	EDGE/EDGE 1.3	GEO/GEO 1.3	BCR/BCR 1.3
Yes	Yes	Yes	Yes	Yes	Yes	Yes	Yes

Communication Tool Input Tab

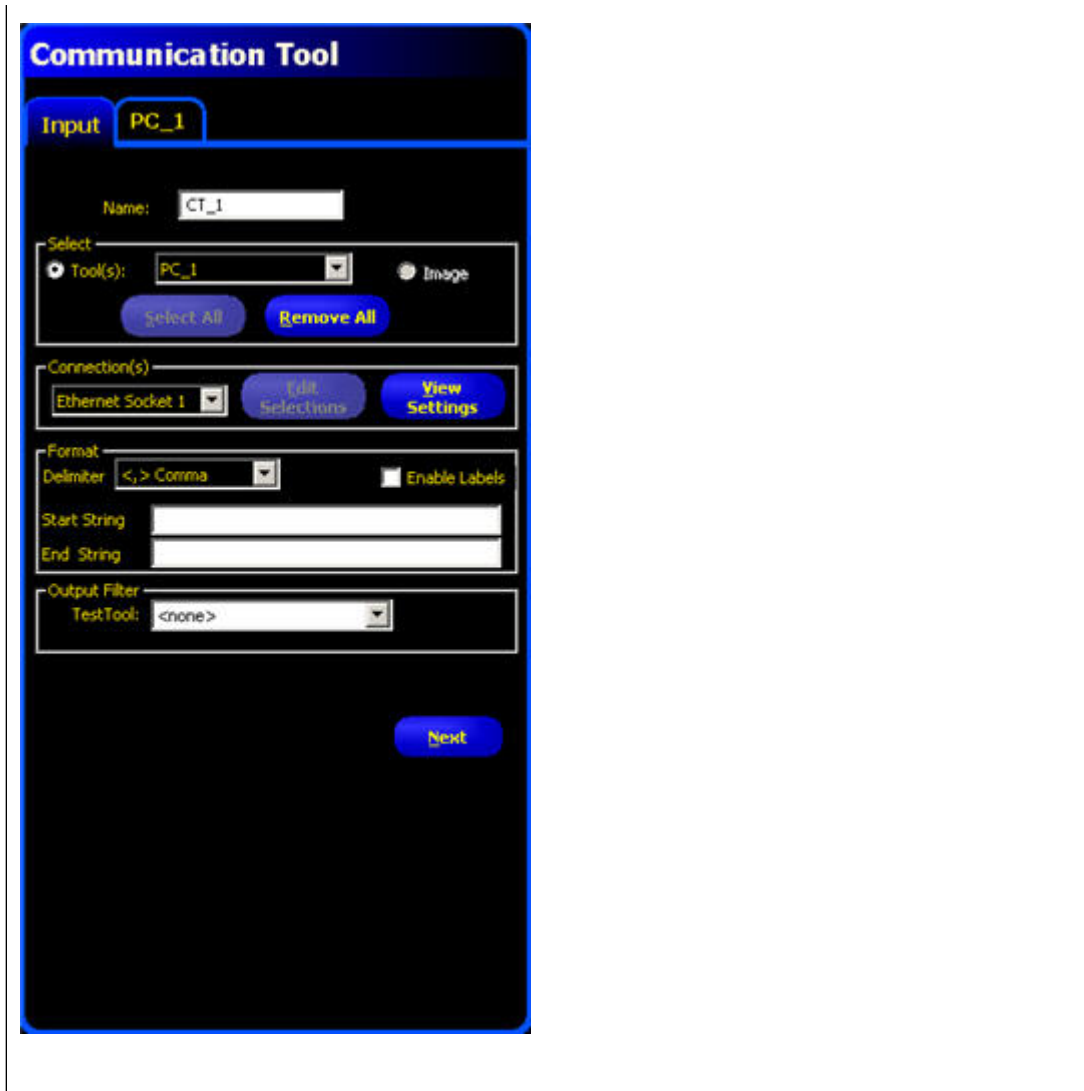

## Adding a Communication Tool

**👉 Important:** Add the Communication tool after the Vision tools that have data to be exported.

The Communication tool can export results data from the first Location, Vision, Analysis, and Test tools as follows:

- In the sequence that the tools are selected within the Communication tool.
- In the sequence that the options are listed within the tools for export

One inspection can have more than one Communication tool.

Use one Communication tool to:

- Export data out of one port (serial or Ethernet).
- Export identical data out of multiple ports at the same time.

Use multiple Communication tools to:

- Separate the data and export separate segments to unique external devices.

- Customize the order of the exported data.
- Export data from the Vision tools at different times during the inspection.
- Customize the “Start Strings” control characters to unique external devices.

**Note:** The Test tool can have the Communication tool as one of its inputs. Therefore, if a Test tool is added after the Communication tool, a discrete output can be activated:

- If the TCP/IP connection is lost.
- If the external device fails to acknowledge it received data.

This output could contribute to an inspection Pass/Fail if it is an input to a Test tool. A Communication tool without a Test tool will not contribute to the inspection Pass/Fail.

### Select

This field provides a drop-down list from which to select tools; select the results to export from the selected tool's tab that appears in the configuration window.

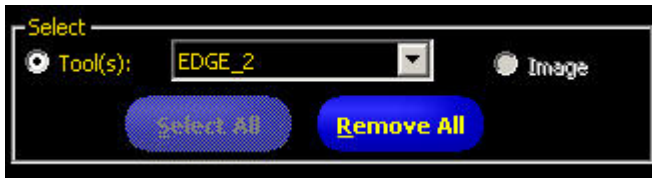

### Connections

This field provides a drop-down list from which to select the communication connection(s) to export the data.

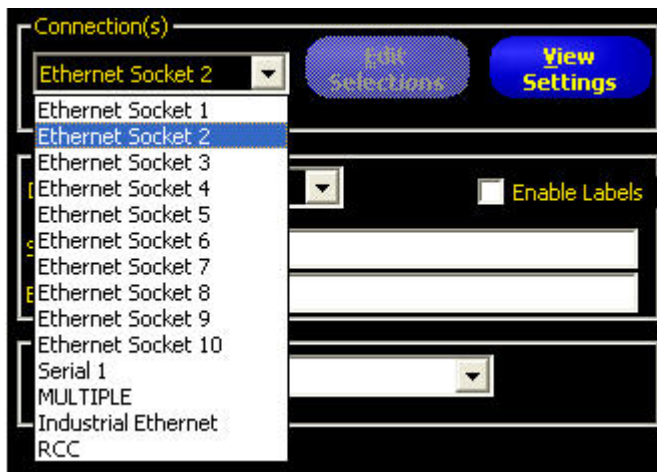

### Format

This field provides options for formatting the ASCII string of data that will be exported.



### Output Filter

This field provides a means to make specific output selections in order to avoid unwanted output information.



### Guidelines for Configuring the Communication Tool

There are four main steps in configuring the Communication tool:

1. Select the Vision tools and their results to export (in the Select field).
  - When a tool is selected, the selected tool’s tab appears in the Configuration window.
  - Click on the tab to select the data to be exported.
2. Select the communication connection(s) that will export the data (in the Connection field).
  - If MULTIPLE is chosen from the drop-down list, then click Edit Selections to select more than one port.
  - Click View Settings to display the configuration of the connection.
  - Data can be sent through 11 different communication connections: one connector for the serial connection, and 10 sockets (1 to 10) through the Ethernet connector.
  - The 10 Ethernet sockets are comprised of the Sensor IP address and port number. The table below lists the default Ethernet socket addresses.

Socket	Default IP Address	Port
1	192.168.0.1	20,000
2	192.168.0.1	20,001
3	192.168.0.1	20,002
4	192.168.0.1	20,003
5	192.168.0.1	20,004
6	192.168.0.1	20,005
7	192.168.0.1	20,006

Socket	Default IP Address	Port
8	192.168.0.1	20,007
9	192.168.0.1	20,008
10	192.168.0.1	20,009

- The serial port is the RS-232 connector (Pins 1, 9, and 10) on the Sensor. The default settings for the serial port are listed below.

Attribute	Default Setting
Baud Rate	115200
Data Bits	8
Parity	None
Stop Bit	1
Flow Control	None

### 3. Format the ASCII string of data (in the Format field).

- Choose a Delimiter and Start and End strings.
- Check the Enable Labels box to add the names for data being sent.

Allowable ASCII string options are shown below.

- 👉 **Note:** Start and End strings can now accept ASCII Hex values, and the following special characters: "\r", "\n", "\t".

Option Name	Values	Description
Delimiter	, <Comma> : <Colon> > <Semicolon> \r\n <CR_LF> Carriage return and then line feed \n\r <LF-CR> Line feed then carriage return \r <CR> Carriage return only \n <LF> Line feed only	The delimiter is used to separate the individual pieces of data being sent. The delimiter will follow every individual segment of data, including start string and end string.
Start String	User-defined ASCII characters (limit of 75 characters)  👉 <b>Note:</b> ASCII Hex characters are allowed. Special symbols such as \r, \n, and \t will cause a carriage return, new line,	This option is a mechanism for adding characters before a string of data.

Option Name	Values	Description
	and tab to be output respectively.	
End String	User-defined ASCII characters (limit of 75 characters)   <b>Note:</b> ASCII Hex characters are allowed. Special symbols such as \r, \n, and \t will cause a carriage return, new line, and tab to be output respectively.	This option is a mechanism for adding characters after a string of data.
Enable Labels	Parameter labels	Check this box to add a label to the data before the data itself. Example: Dark Count = 3, where "Dark Count=" is the label.

4. Set conditions for conditionally exporting the selected data (in the Output Filter field).
- Select **Pass** to export the selected information on a passing Test tool.
  - Select **Fail** to export the selected information on a failing Test tool.

### Communication Tool Exportable Results

The Communication tool sends out the data in the same sequence that the tools appear in the inspection, and the result of transmitting this data will increase the inspection time.

The following shows the data sent out for each Communication tool.

Result	Value	Description
Success	1 = The connection is valid, and data will be sent.	Checks the connection (Ethernet only).
Execution time	Given in ms.	Processing time for the Sensor to send the data out.

The table below shows the format of the data.

Result*	Number	Format	Example
Point (X,Y)	Decimal	(0.00, 00.00)	(23.41, 156.52)
Distance	Decimal	00.00	99.00
Count	Whole	0	4

\* Available data is tool and model-dependent.

### Location Tools

- [Communication Tool Exportable Results: Locate Tool](#)7.4.1.7.1 [Communication Tool Exportable Results: Locate Tool](#) on page 128
- [Communication Tool Exportable Results: Geometric Find Tool](#)7.4.1.7.2 [Communication Tool Exportable Results: Geometric Find Tool](#) on page 128
- [Communication Tool Exportable Results: Pattern Find Tool](#)7.4.1.7.3 [Communication Tool Exportable Results: Pattern Find Tool](#) on page 128

#### **Gray Scale Tools**

- [Communication Tool Exportable Results: Blob Detect Tool](#)7.4.1.7.4 [Communication Tool Exportable Results: Blob Detect Tool](#) on page 129
- [Communication Tool Exportable Results: Edge Tool](#)7.4.1.7.5 [Communication Tool Exportable Results: Edge Tool](#) on page 129
- [Communication Tool Exportable Results: Geometric Count Tool](#)7.4.1.7.6 [Communication Tool Exportable Results: Geometric Count Tool](#) on page 130
- [Communication Tool Exportable Results: Object Tool](#)7.4.1.7.7 [Communication Tool Exportable Results: Object Tool](#) on page 130
- [Communication Tool Exportable Results: Pattern Count Tool](#)7.4.1.7.8 [Communication Tool Exportable Results: Pattern Count Tool](#) on page 131

#### **Color Tools**

- [Communication Tool Exportable Results: Average Color Tool](#)7.4.1.7.9 [Communication Tool Exportable Results: Average Color Tool](#) on page 131
- [Communication Tool Exportable Results: Color Blob Tool](#)7.4.1.7.10 [Communication Tool Exportable Results: Color Blob Tool](#) on page 132
- [Communication Tool Exportable Results: Color Match Tool](#)7.4.1.7.11 [Communication Tool Exportable Results: Color Match Tool](#) on page 132

#### **Premium Tools**

- [Communication Tool Exportable Results: Barcode Tool](#)7.4.1.7.12 [Communication Tool Exportable Results: Barcode Tool](#) on page 133
- [Communication Tool Exportable Results: Bead Tool](#)7.4.1.7.13 [Communication Tool Exportable Results: Bead Tool](#) on page 133
- [Communication Tool Exportable Results: OCR Tool](#)7.4.1.7.14 [Communication Tool Exportable Results: OCR Tool](#) on page 134
- [Communication Tool Exportable Results: OCV Tool](#)7.4.1.7.15 [Communication Tool Exportable Results: OCV Tool](#) on page 134

#### **Analysis Tools**

- [Communication Tool Exportable Results: Math Tool](#)7.4.1.7.16 [Communication Tool Exportable Results: Math Tool](#) on page 135
- [Communication Tool Exportable Results: Measure Tool](#)7.4.1.7.17 [Communication Tool Exportable Results: Measure Tool](#) on page 135
- [Communication Tool Exportable Results: String Tool](#)7.4.1.7.18 [Communication Tool Exportable Results: String Tool](#) on page 136
- [Communication Tool Exportable Results: Test Tool](#)7.4.1.7.19 [Communication Tool Exportable Results: Test Tool](#) on page 136

**Communication Tool Exportable Results: Locate Tool**

Data Label	Value	Description
Tool Name	string	User-defined name
Success	1 or 0	1 = Tool executed successfully 0 = Tool did not find a point to use as a reference
Execution Time	ms	Fastest recorded tool processing time since the start of the inspection or since power-up.
Execution Time Min	ms	Fastest recorded tool processing time for the current inspection or since power-up.
Execution Time Max	ms	Slowest recorded tool processing time since the start of the inspection or since power-up.
Edge Offset Point	pixels (X, Y)	Distance from the reference edge to the current edge.
Edge Location Point	pixels (X, Y)	X, Y coordinates of the current edge.
Rotation	degrees	Amount of rotation from the current edge to the reference edge.
Rotation Origin	pixels (X, Y)	X, Y coordinates of the point from which ROIs will rotate.

**Communication Tool Exportable Results: Geometric Find Tool**

Data Label	Value	Description
Tool Name	string	User-defined name
Success	1 or 0	1 = Tool executed successfully 0 = Tool did not find a point to use as a reference
Execution Time	ms	Tool processing time for the current inspection.
Execution Time Min	ms	Fastest recorded tool processing time since the start of the inspection or since power-up.
Execution Time Max	ms	Slowest recorded tool processing time since the start of the inspection or since power-up.
Rotation Origin	pixels (X, Y)	X, Y coordinates of the point from ROIs will rotate.
Best Match Rotation	degrees	Rotational value of the first pattern found.
Best Match Location Point	pixels (X, Y)	X, Y coordinates of the first pattern found.
Best Match %	20-100%	Percent match of the first pattern found.

**Communication Tool Exportable Results: Pattern Find Tool**

Data Label	Value	Description
Tool Name	string	User-defined name
Success	1 or 0	1 = Tool executed successfully 0 = Tool did not find a point to use as a reference



Data Label	Value	Description
Execution Time	ms	Tool processing time for the current inspection.
Execution Time Min	ms	Fastest recorded tool processing time since the start of the inspection or since power-up.
Execution Time Max	ms	Slowest recorded tool processing time since the start of the inspection or since power-up.
Match Acceptance Level Range Min	20 - 100%	Minimum percent the current pattern must match the reference pattern to be considered a match.
Match Acceptance Level Range Max	20 - 100%	Maximum percent the current pattern must match the reference pattern to be considered a match.
Rotation Origin	pixels (X,Y)	X, Y coordinates of the point from which ROIs will rotate.
First Match Rotation	degrees	Rotational value of the first pattern found.
First Match Location Point	pixels (X, Y)	X,Y coordinates of the first pattern found.
% Match of First Pattern Found	15 - 100%	Percent match of the first pattern found.

#### Communication Tool Exportable Results: Blob Detect Tool

Data Label	Value	Description
Tool Name	string	User-defined name
Execution Time	ms	Tool processing time for the current inspection.
Execution Time Min	ms	Fastest recorded tool processing time since the start of the inspection or since power-up.
Execution Time Max	ms	Slowest recorded tool processing time since the start of the inspection or since power-up.
Count	whole number	Number of Blobs found.
Total Area	pixels	Number of pixels when combining all Blobs found.
Largest Blob Area	pixels	Number of pixels in the largest Blob.
Largest Location	pixels (X, Y)	Centroid of the largest Blob.
Smallest Blob Area	pixels	Number of pixels in the smallest Blob.
Smallest Location	pixels (X, Y)	Centroid of the smallest Blob.

#### Communication Tool Exportable Results: Edge Tool

Data Label	Value	Description
Tool Name	string	User-defined name
Execution Time	ms	Tool processing time for the current inspection.
Execution Time Min	ms	Fastest recorded tool processing time since the start of the inspection or since power-up.

Data Label	Value	Description
Execution Time Max	ms	Slowest recorded tool processing time since the start of the inspection or since power-up.
Bright-to-Dark Count	whole number	Total number of bright-to-dark edges.
Dark-to-Bright Count	whole number	Total number of dark-to-bright edges.
Total Edge Count	whole number	Total number of all edges.
Location(s)	pixels (X, Y)	X, Y coordinates of all the edges found.

### Communication Tool Exportable Results: Geometric Count Tool

Data Label	Value	Description
Tool Name	string	User-defined name
Success	1 or 0	1 = Tool executed successfully 0 = Tool did not find a point to use as a reference
Execution Time	ms	Tool processing time for the current inspection.
Execution Time Min	ms	Fastest recorded tool processing time since the start of the inspection or since power-up.
Execution Time Max	ms	Slowest recorded tool processing time since the start of the inspection or since power-up.
Match Count	whole number	Total number of patterns above the minimum acceptance level and below the maximum number of patterns.
Rotation Origin	pixels (X, Y)	X, Y coordinates of the point from ROIs will rotate.
Match Rotation	degrees	Rotational value of the first pattern found.
Best Match Location Point	pixels (X, Y)	X, Y coordinates of the first pattern found.
Best Match %	20-100%	Percent match of the first pattern found.

### Communication Tool Exportable Results: Object Tool

Data Label	Value	Description
Tool Name	string	User-defined name
Execution Time	ms	Tool processing time for the current inspection.
Execution Time Min	ms	Fastest recorded tool processing time since the start of the inspection or since power-up.
Execution Time Max	ms	Slowest recorded tool processing time since the start of the inspection or since power-up.
Dark Count	whole number	Total number of dark objects.
Total Object Count	whole number	Total number of all objects.
Min Bright Object Width	pixels	Width of the smallest bright object found.

Data Label	Value	Description
Max Bright Object Width	pixels	Width of the largest bright object found.
Min Dark Object Width	pixels	Width of the smallest dark object found.
Max Dark Object Width	pixels	Width of the largest dark object found.
Width(s)	pixels	Widths of all objects found.
Location(s)	pixels (X, Y)	Midpoint position of all the objects found.

### Communication Tool Exportable Results: Pattern Count Tool

Data Label	Value	Description
Tool Name	string	User-defined name
Execution Time	ms	Tool processing time for the current inspection.
Execution Time Min	ms	Fastest recorded tool processing time since the start of the inspection or since power-up.
Execution Time Max	ms	Slowest recorded tool processing time since the start of the inspection or since power-up.
Match Count	whole number	Total number of patterns above the minimum acceptance level and below the maximum acceptance level.
Match Acceptance Level Range Min	20 - 100%	Minimum percent the current pattern must match the reference pattern to be considered a match.
Match Acceptance Level Range Max	20 - 100%	Maximum percent the current pattern must match the reference pattern to be considered a match.
Rotation Origin	pixels (X,Y)	X, Y coordinates of the point from which ROIs will rotate.
First Match Rotation	degrees	Rotational value of the first pattern found.
First Match Location Point	pixels (X, Y)	X,Y coordinates of the first pattern found.
% Match of Pattern(s) Found	15 - 100%	Percent match of the first pattern found.

### Communication Tool Exportable Results: Average Color Tool

Data Label	Value	Description
Tool Name	string	User-defined name
Success	1 or 0	1 = Tool executed successfully 0 = Tool did not find a point to use as a reference
Execution Time	ms	Tool processing time for the current inspection.
Execution Time Min	ms	Fastest recorded tool processing time since the start of the inspection or since power-up.
Execution Time Max	ms	Slowest recorded tool processing time since the start of the inspection or since power-up.

**Communication Tool Exportable Results: Color Blob Tool**

Data Label	Value	Description
Tool Name	string	User-defined name
Success	1 or 0	1 = Tool overall results passed. 2 = Tool overall results failed.
Execution Time	ms	Tool processing time for the current inspection.
Execution Time Min	ms	Fastest recorded tool processing time since the start of the inspection or since power-up.
Execution Time Max	ms	Slowest recorded tool processing time since the start of the inspection or since power-up.
Threshold		
Threshold Min		
Threshold Max		
Count		
Areas		
Total Area	pixels	Total number of pixels in all the color Blobs.
Largest Blob Area	pixels	Number of pixels in the largest color Blob.
Largest Blob Location	pixels (X, Y)	Centroid of the largest color Blob.
Smallest Blob Area	pixels	Number of pixels in the smallest color Blob.
Smallest Blob Location	pixels (X, Y)	Centroid of the smallest color Blob.
Locations		

**Communication Tool Exportable Results: Color Match Tool**

Data Label	Value	Description
Tool Name	string	User-defined name
Success	1 or 0	1 = Tool executed successfully 0 = Tool did not find a point to use as a reference
Execution Time	ms	Tool processing time for the current inspection.
Execution Time Min	ms	Fastest recorded tool processing time since the start of the inspection or since power-up.
Execution Time Max	ms	Slowest recorded tool processing time since the start of the inspection or since power-up.
Color Match Test Result		
Color Match Percent	%	
Match Percent Threshold	%	
Brightness	whole number	The grayscale brightness. This value ranges from 0 to 255.

Data Label	Value	Description
Brightness Lower Limit	whole number	The grayscale brightness lower limit. This value ranges from 0 to 255.
Brightness Upper Limit	whole number	The grayscale brightness upper limit. This value ranges from 0 to 255.

### Communication Tool Exportable Results: Barcode Tool

Data Label	Value	Description
Tool Name	string	User-defined name
Success		
Execution Time	ms	Tool processing time for the current inspection.
Execution Time Min	ms	Fastest recorded tool processing time since the start of the inspection or since power-up.
Execution Time Max	ms	Slowest recorded tool processing time since the start of the inspection or since power-up.
Max Time Exceeded		
Number Found	whole number	
Coordinates of Barcodes Found		
Barcode Type		
Symbol Type		
Number of Barcode Data Elements Read	whole number	
Barcode Data Read		
Barcode Read Status		
2-D Symbol Dimensions		

### Communication Tool Exportable Results: Bead Tool

Data Label	Value	Description
Tool Name	string	User-defined name
Success	1 or 0	1 = Tool overall results passed. 2 = Tool overall results failed.
Execution Time	ms	Tool processing time for the current inspection.
Execution Time Min	ms	Fastest recorded tool processing time since the start of the inspection or since power-up.
Execution Time Max	ms	Slowest recorded tool processing time since the start of the inspection or since power-up.
Threshold Used		

Data Label	Value	Description
Minimum Width Found		
Maximum Width Found		
Average Width Found		
Number of Good Regions		
Total Length of Good Regions		
Good Region Lengths		
Longest Good Region Length		
Number of Narrow Regions		
Total Length of Narrow Regions		
Narrow Region Lengths		
Longest Narrow Region Length		
Number of Wide Regions		
Total Length of Wide Regions		
Wide Region Lengths		
Longest Wide Region Length		

### Communication Tool Exportable Results: OCR Tool

Data Label	Value	Description
Tool Name	string	User-defined name
Success	1 or 0	1 = Tool overall results passed. 2 = Tool overall results failed.
Execution Time	ms	Tool processing time for the current inspection.
Execution Time Min	ms	Fastest recorded tool processing time since the start of the inspection or since power-up.
Execution Time Max	ms	Slowest recorded tool processing time since the start of the inspection or since power-up.
Max Time Exceeded		
String Read	string	
String Length	whole number	

### Communication Tool Exportable Results: OCV Tool

Data Label	Value	Description
Tool Name	string	User-defined name
Success	1 or 0	1 = Tool overall results passed. 2 = Tool overall results failed.

Data Label	Value	Description
Execution Time	ms	Tool processing time for the current inspection.
Execution Time Min	ms	Fastest recorded tool processing time since the start of the inspection or since power-up.
Execution Time Max	ms	Slowest recorded tool processing time since the start of the inspection or since power-up.
Max Time Exceeded		
String Read		
String Length		
OCV Result		
Expected String		

### Communication Tool Exportable Results: Math Tool

Data Label	Value	Description
Tool Name	string	User-defined name
Success	1 or 0	1 = Tool overall results passed. 2 = Tool overall results failed.
Execution Time	ms	Tool processing time for the current inspection.
Execution Time Min	ms	Fastest recorded tool processing time since the start of the inspection or since power-up.
Execution Time Max	ms	Slowest recorded tool processing time since the start of the inspection or since power-up.
Output		

### Communication Tool Exportable Results: Measure Tool

Data Label	Value	Description
Tool Name	string	User-defined name
Execution Time	ms	Tool processing time for the current inspection.
Execution Time Min	ms	Fastest recorded tool processing time since the start of the inspection or since power-up.
Execution Time Max	ms	Slowest recorded tool processing time since the start of the inspection or since power-up.
Distance	pixels	Total distance from the points selected for Tool One and Tool Two.î
Distance X	pixels	Horizontal component (X) of the total distance.
Distance Y	pixels	Vertical component (Y) of the total distance.
Origin Point	pixels (X, Y)	X, Y coordinates of the origin point.

Data Label	Value	Description
Measure Location Point 1	pixels (X,Y)	X,Y coordinates of the point selected for Tool One.
Measure Location Point 2	pixels (X,Y)	X,Y coordinates of the point selected for Tool Two.

### Communication Tool Exportable Results: String Tool

Data Label	Value	Description
Tool Name	string	User-defined name
Success	1 or 0	1 = Tool overall results passed. 2 = Tool overall results failed.
Execution Time	ms	Tool processing time for the current inspection.
Execution Time Min	ms	Fastest recorded tool processing time since the start of the inspection or since power-up.
Execution Time Max	ms	Slowest recorded tool processing time since the start of the inspection or since power-up.
Max Time Exceeded		
Operand 1		
Operand 2		
Operation Result		

### Communication Tool Exportable Results: Test Tool

Data Label	Value	Description
Tool Name	string	User-defined name
Success	1 or 0	1 = Tool overall results passed. 2 = Tool overall results failed.
Execution Time	ms	Tool processing time for the current inspection.
Execution Time Min	ms	Fastest recorded tool processing time since the start of the inspection or since power-up.
Execution Time Max	ms	Slowest recorded tool processing time since the start of the inspection or since power-up.
Input1	1, 0, or -1	1 = Input 1 results passed. 0 = Input 1 results failed. -1 = Input1 results not defined.
Input2	1, 0, or -1	1 = Input 2 results passed. 0 = Input 2 results failed. -1 = Input2 results not defined.



Data Label	Value	Description
Input3	1, 0, or -1	1 = Input 3 results passed. 0 = Input 3 results failed. -1 = Input3 results not defined.
Input4	1, 0, or -1	1 = Input 4 results passed. 0 = Input 4 results failed. -1 = Input4 results not defined.
Output	1 or 0	1 = Tool overall results passed. 0 = Tool overall results failed.

## 7.4.2 Coordinate Tool

The Coordinate tool takes coordinate values from different vision tools and combines them into a single output representing object x and y coordinates as well as a rotational offset from a default position defined in the inspection.

The Coordinate tool can accept x, y coordinates, and angle (Theta) data from any tool that produces locational information as part of the results:

- Locate tool
- Geometric Find tool
- Pattern Find tool
- Blob Find tool
- Blob Detect tool
- Color Blob tool
- Pattern Count tool
- Geometric Count tool
- Edge tool
- Object tool
- Barcode tool
- BCR tool
- Measure tool
- Math tool

 **Note:** The Coordinate tool also accepts user-defined constants for any of these values. Additionally, not all tools (for example, Barcode) produce angle data.

The Coordinate tool can be used with the PresencePLUS Remote Command Channel (RCC), which is used to interface and operate industrial robots.

### Fields

The following are fields on the Coordinate tool Input tab:

- [Coordinate Tool Inputs](#) **7.4.2.1 Coordinate Tool Inputs** on page 138

### Supported Platforms

ProII Color	ProII/ProII 1.3	OMNI Color	OMNI/OMNI 1.3	AREA/AREA13	EDGE/EDGE 1.3	GEO/GEO 1.3	BCR/BCR 1.3
Yes	Yes	Yes	Yes	No	No	No	No

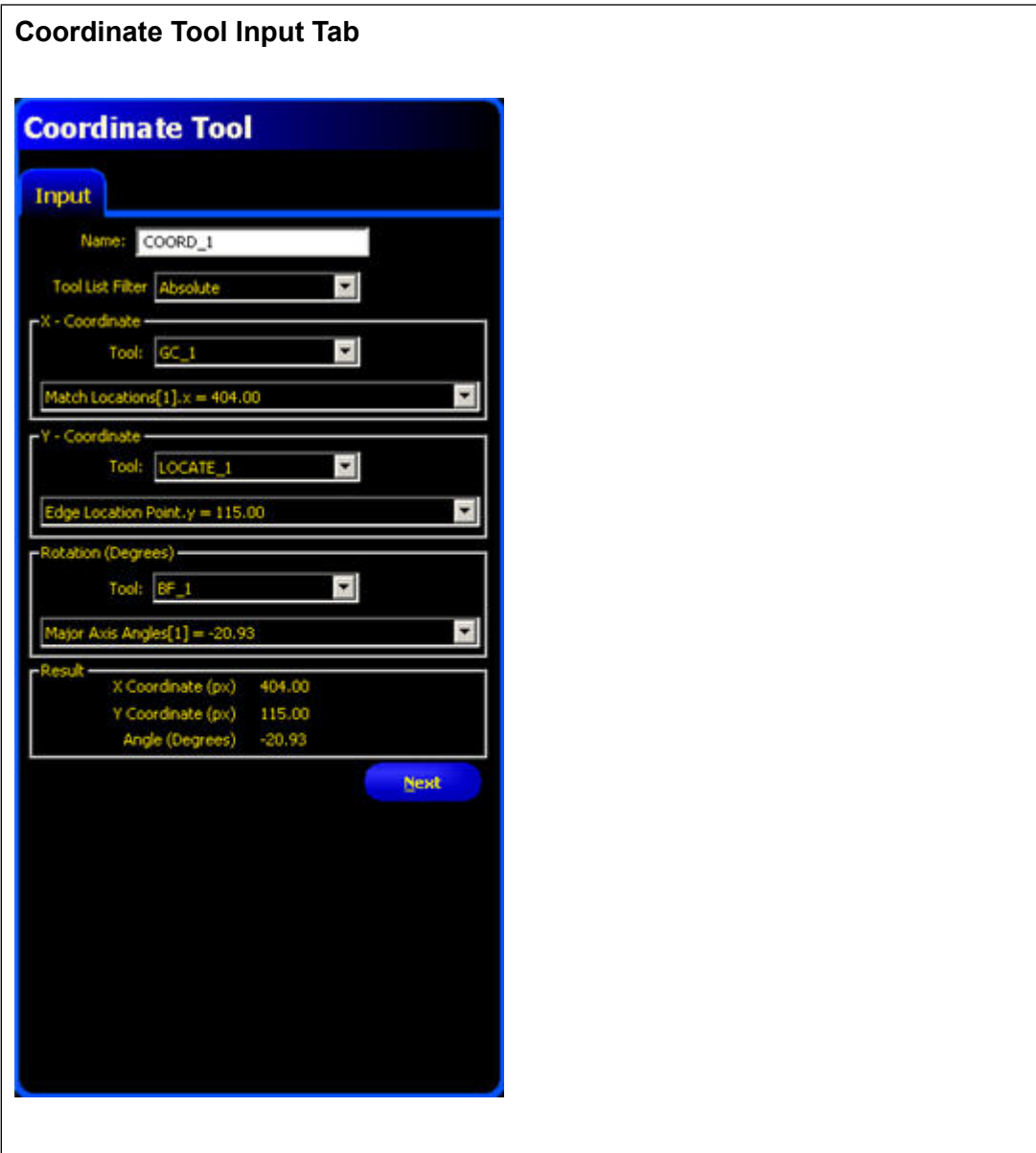

## Coordinate Tool Inputs

### Tool List Filter

The Tool List Filter helps to limit the input data available for x,y coordinates and angle data. From the drop-down, select either of the following:

- **Absolute**—this is the default, and enables x and y location data as well as angle information from any tools that provide this data.
- **Offset Only**—which enables the selection of location offsets of x and y coordinates and angle data from location tools.



### X - Coordinate

From the drop-down list of available tools that provide x and y coordinate data, select a tool or, to enter a constant value, select CONSTANT.

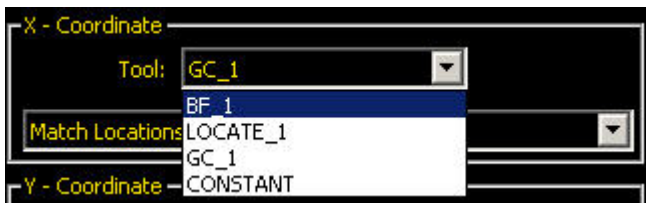

Select x or y coordinate information for that tool.

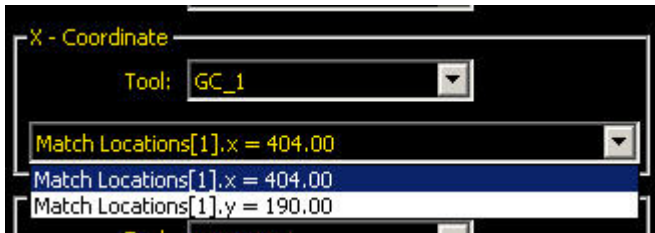

### Y - Coordinate

From the drop-down list of available tools that provide x and y coordinate data, select a tool or, to enter a constant value, select CONSTANT.

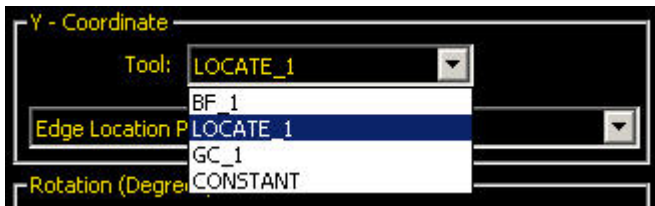

Select x or y coordinate information for that tool.

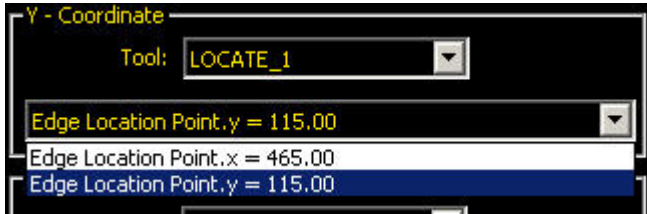

### Rotation (Degrees)

From the drop-down list of available tools that provide angle data, select a tool or, to enter a constant value, select CONSTANT.

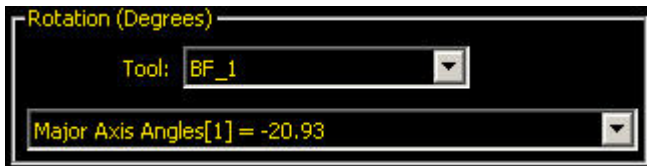

### Result

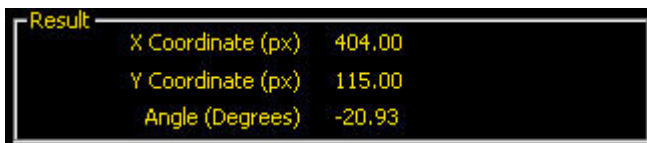

### Coordinate Tool and the Remote Command Channel (RCC)

The Coordinate tool can be used with the PresencePLUS RCC to interface with industrial robots. The RCC can get or set x,y coordinates, angle information, or the entire set of Coordinate tool data:

- get *coordinate\_tool\_identifier* returns all the Coordinate tool outputs separated by the field delimiter and bounded by start and end frame delimiters (as configured for the RCC).
- get coordtool *coordinate\_tool\_identifier* [ x | y | angle ] returns the specified Coordinate tool output.
- set coordtool *coordinate\_tool\_identifier* [ x | y | angle ] sets value for the specified input.

 **Note:** The *coordinate\_tool\_identifier* can be a tool name or a tool number.

### 7.4.3 Math Tool

The Math tool provides basic arithmetic, inequality expressions, and statistical information for PresencePLUS inspections. In general, the Math tool takes one or more pieces of information from Vision tools and makes mathematical expressions out of them. The results of the Math tool's analysis are displayed in the Result windows at the bottom of the screen.

The inputs to the Math tool are called Operands. The Operation is the mathematical expression used to analyze the Operands.

#### Fields

The following are fields on the Math tool Input tab:

- [Math Tool Modes](#) on page 142
- [Use of Constants](#) on page 145
- [Results](#) on page 145

**Supported Platforms**

ProII Color	ProII/ProII 1.3	OMNI Color	OMNI/OMNI 1.3	AREA/AREA13	EDGE/EDGE 1.3	GEO/GEO 1.3	BCR/BCR 1.3
Yes	Yes	Yes	Yes	Yes	Yes	Yes	Yes

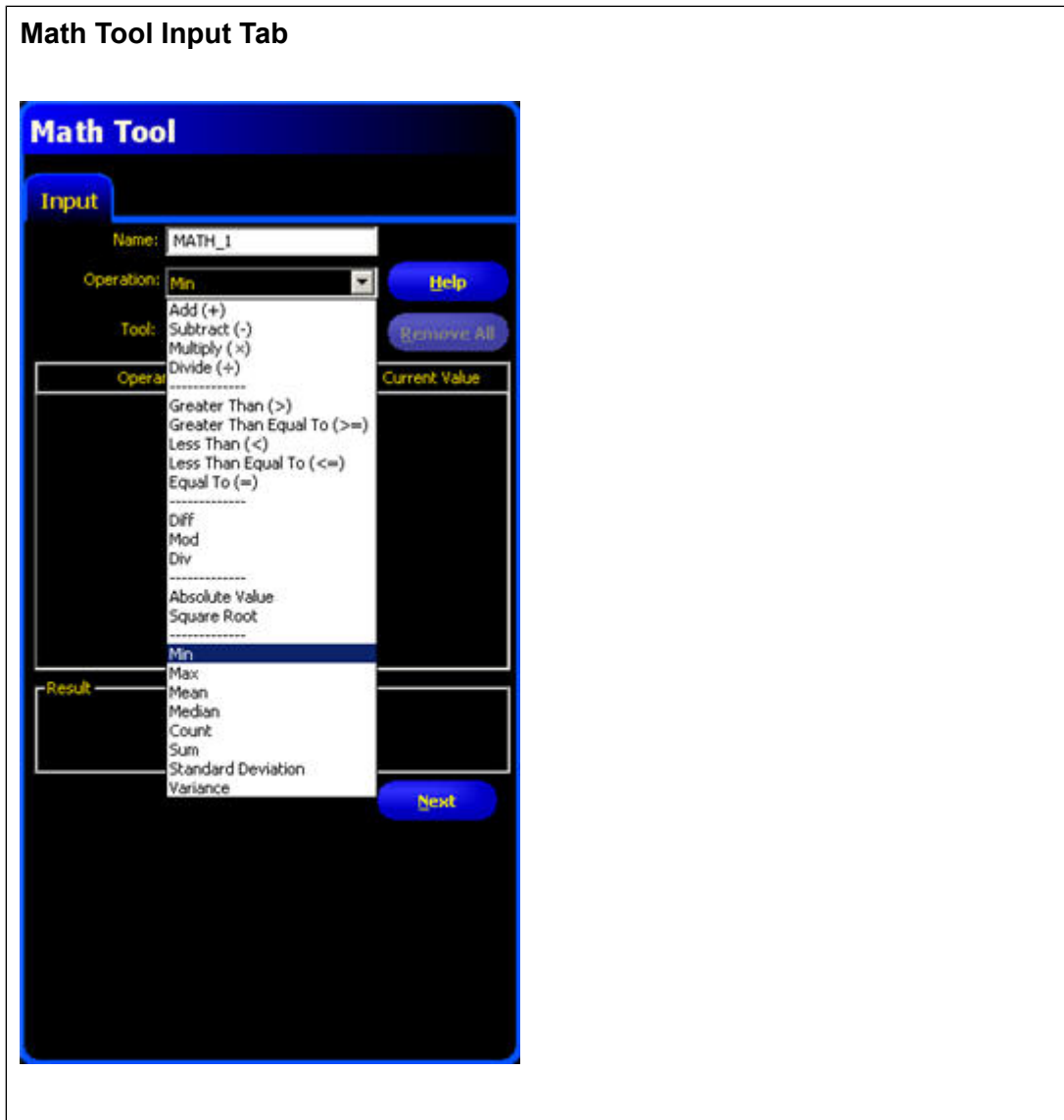

## Math Tool Modes

### One Operand Operation

There is only one operation that requires a single Operand--Absolute Value. This Operator requires the user to provide only one Operand.

#### One Operand Functions

<b>abs</b>	<p>Abs (Absolute value) returns <math>Abs(X_1)</math>.</p> <p>The absolute value of an operand is its unsigned magnitude. For example, <math>Abs(-1.5)</math> and <math>Abs(1.5)</math> both return 1.5</p>
------------	---

### Two Operand Operations

Two Operand Operations require two inputs (Operand 1 and Operand 2). For each operand, you specify:

- the vision tool (or a constant)

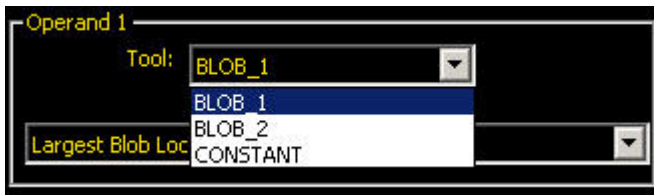

- a specific attribute of interest for that tool.

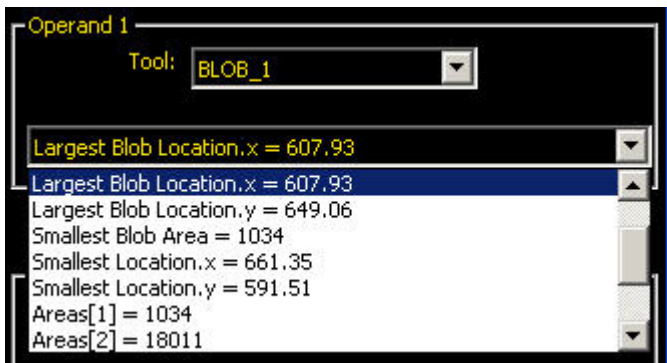

The following are classified as Two Operand Operations:

- Add
- Subtract
- Multiply
- Divide
- Greater Than
- Greater Than Equal To
- Less Than

- Less Than Equal To
- Equal To
- Diff
- Mod
- Div

### *Arithmetic Operations*

<b>Add</b>	Returns $(X_1 + X_2)$
<b>Subtract</b>	Returns $(X_1 - X_2)$
<b>Multiply</b>	Returns $(X_1 * X_2)$
<b>Divide</b>	Returns $(X_1 / X_2)$

### *Relational Operations*

<b>Greater Than</b>	If $(X_1 > X_2)$ returns True, else False.
<b>Greater Than or Equal To</b>	If $(X_1 \geq X_2)$ returns True, else False.
<b>Less Than</b>	If $(X_1 < X_2)$ returns True, else False.
<b>Less Than or Equal To</b>	If $(X_1 \leq X_2)$ returns True, else False.
<b>Equal To</b>	If $(X_1 = X_2)$ returns True, else False.

If the output of relational operation is used as an input for another Math Tool, True interpreted as 1 and False interpreted as 0.

### *Two Operand Functions*

<b>Diff (Difference)</b>	Returns $\text{Abs}(X_1 - X_2)$ . Returns the difference - absolute value of the difference between two operands.
<b>Mod (Modulus)</b>	Returns $\text{Mod}(X_1 / X_2)$ . The modulus, or remainder, operator divides operand1 by operand2 and returns the remainder.
<b>Div (Integer Division)</b>	Returns $\text{Div}(X_1 \div X_2)$ . Returns the integer part of division, remainder is discarded.

### **Multiple Operand Operations**

Multiple Operand Operations allow the user to make a long list of input data. All of these pieces of information are inputs to the selected Operation.

For example, select Min as the Operation, and select an input tool. A tab is created for the input tool. Click on this tab to specify the attribute(s) of the vision tool that will be the Operands. Multiple tools can contribute multiple Operands to the list as shown in the examples below.

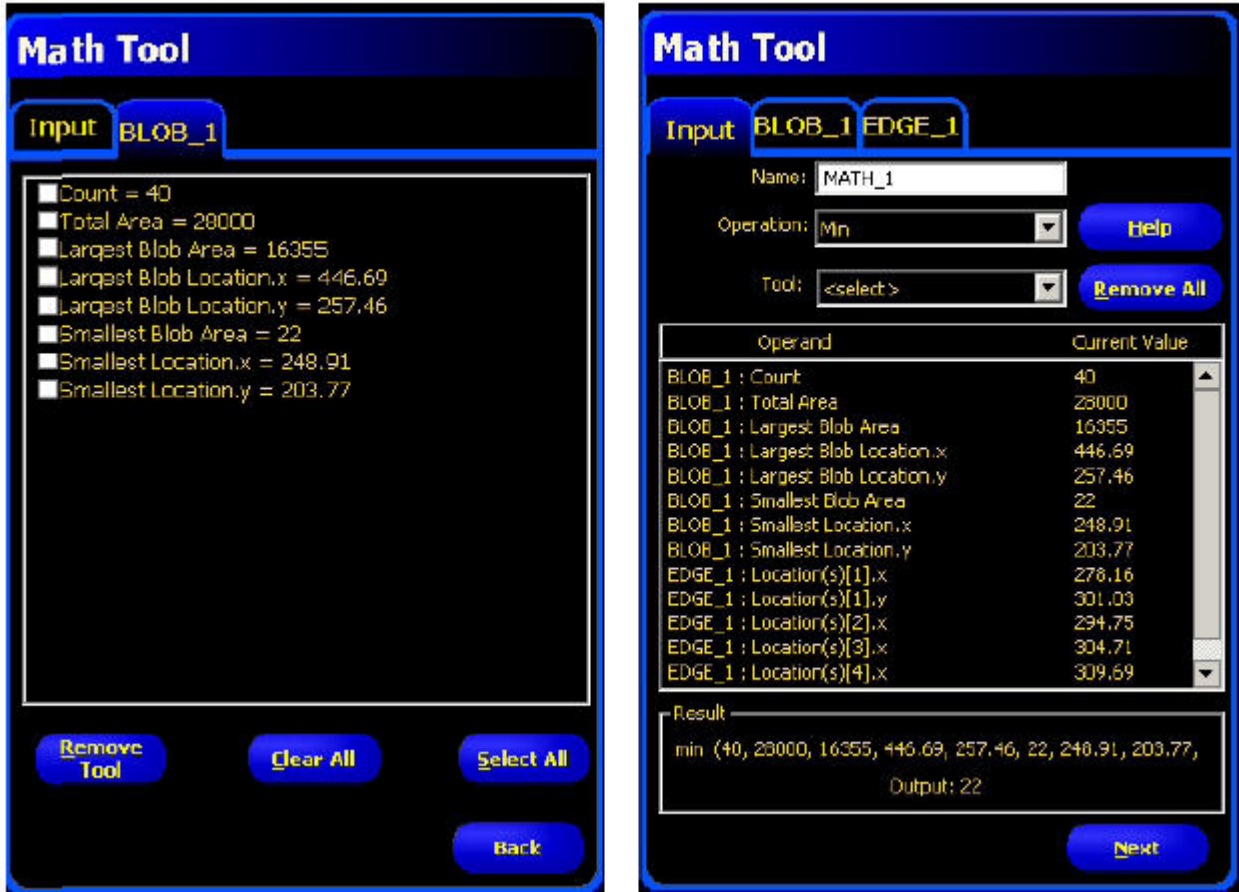

Math tool outputs can be sent out via a Communications tool and/or used as an input to a Test tool (or another Math tool).

*Multiple Operand Functions*

<b>Min (Minimum)</b>	Returns Min ( $X_1, X_2, \dots, X_n$ ). Returns the operand with the lowest value.
<b>Max (Maximum)</b>	Returns Max ( $X_1, X_2, \dots, X_n$ ). Returns the operand with the highest value.
<b>Count</b>	Returns Count ( $X_1, X_2, \dots, X_n$ ). Returns the count of operands.
<b>Sum</b>	Returns Sum ( $X_1, X_2, \dots, X_n$ ). Returns the arithmetic sum of operands.
<b>Mean</b>	Returns Sum ( $X_1, X_2, \dots, X_n$ ) ÷ Count ( $X_1, X_2, \dots, X_n$ ). Returns the mean value of operands.
<b>Median</b>	The statistical median is middle number of a group of numbers that have been arranged in order by size. If there is an even number of terms, the median is the mean of the two middle numbers.



<b>StdDev (Standard Deviation) and Variance</b>	The standard deviation and variance are measures of how spread out operands values are.
---	---

### Use of Constants

In general, a user-defined constant can be selected as one of the Operands for the Math tool. This allows for a number of things, including scaling the output of a vision tool in real units (by dividing that output by a known conversion factor). Along the same lines, dynamic scaling of outputs is also possible by dividing one Operand by another and then multiplying by a constant conversion factor. In this case, two Math tools would be used: one set for Division, the other for Multiplication. The output of the first Math tool would be an Operand for the second Math tool.

### Results

The output of the math operation selected for the inputs is displayed in the results area of the Math tool Input tab.

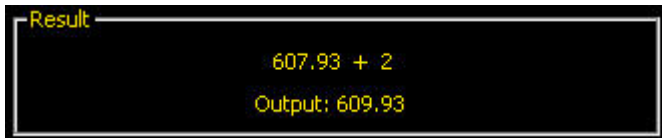

### Math Tool and the Remote Command Channel (RCC)

Syntax	Description
set mathtool <i>tool_name tool_number operand_1 operand_2</i>	Sets the specified tool operand, if it is a constant. Value should be a floating number.
get mathtool <i>tool_name tool_number operand_1 operand_2</i>	Gets the value of the specified tool operand, if it is a constant.

## 7.4.4 Measure Tool

Measure tool can be used to measure distance, calculate angles, and create points and lines for use as inputs to other Measure Tools.

There are three Measure Tool operations:

- Measure from a point to a point
- Intersect two lines
- Measure from a line to a point
- Measure a curve to a point
- Measure a curve to a line

In these operations, points are generated by a variety of vision tools and lines are created by other Measure Tools.

#### Usage

- Determine the location of a Blob

- Determine the distance between Blobs
- Determine a distance between a Blob and a closest point on a bead
- Determine a distance between a Blob and a farthest point on a bead

**Fields**

The following are fields on the Measure tool Input tab:

- [Measure Tool Operations](#) 7.4.4.1 [Measure Tool Operations](#) on page 147
- [Measurement Type](#) 7.4.4.2 [Measurement Type](#) on page 155

**Supported Platforms**

ProII Color	ProII/ProII 1.3	OMNI Color	OMNI/OMNI 1.3	AREA/AREA13	EDGE/EDGE 1.3	GEO/GEO 1.3	BCR/BCR 1.3
Yes	Yes	Yes	Yes	Yes	Yes	Yes	Yes

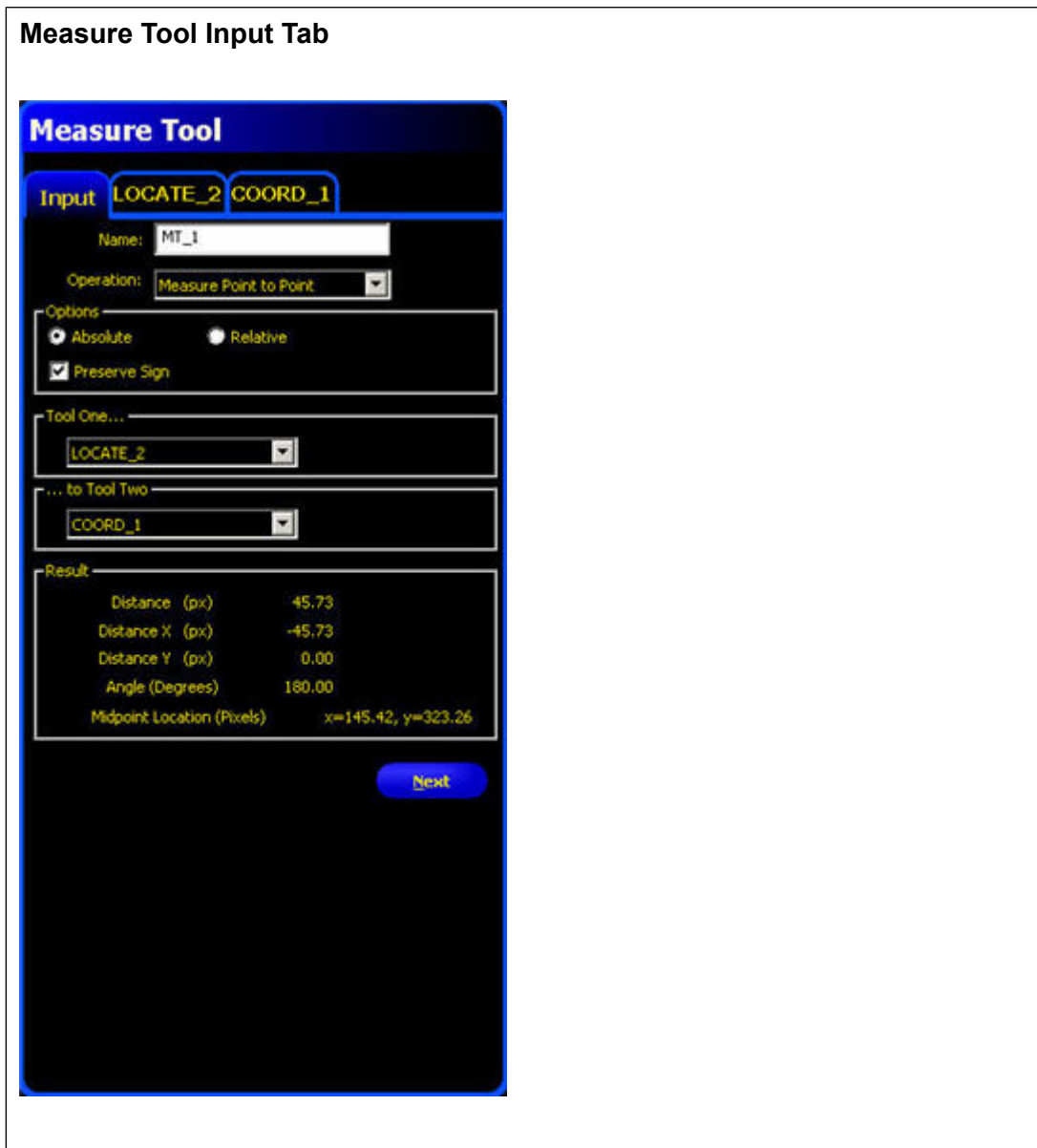

## Measure Tool Operations

### Measure from a Point to a Point

In this operation, the distance between two points is calculated. In addition, the X and Y components of that distance calculation are returned.

Along with distance, the following results are generated in this operation:

- A line from point 1 to point 2
- The angle of that line (relative to the x-axis)
- The midpoint of point 1 and point 2

### Intersect Two Lines

In this operation, the results of the intersection of two lines is generated. These results are:

- The angle of intersection between the two lines
- The intersection point

### Measure from a Line to a Point

In this operation, the software calculates the distance between a line and a point. This is the shortest distance from the line to the point, and is generated by creating a line perpendicular to the original line that intersects the point. In addition, it returns the distance calculations for the X and Y component.

Additionally, the following results are generated in this operation:

- The perpendicular line
- The angle of that line (relative to the x-axis)
- The intersection point between the original line and the perpendicular line

### Measure from a Curve to a Point

This operation is available if a Bead Tool has been added to the inspection prior to the particular instance of the Measure Tool being edited. In this operation, the software calculates the distance between a curve and a point. This measurement can be from either the closest or the farthest point on the curve, and is selected in the Bead tab in the Measure Tool.

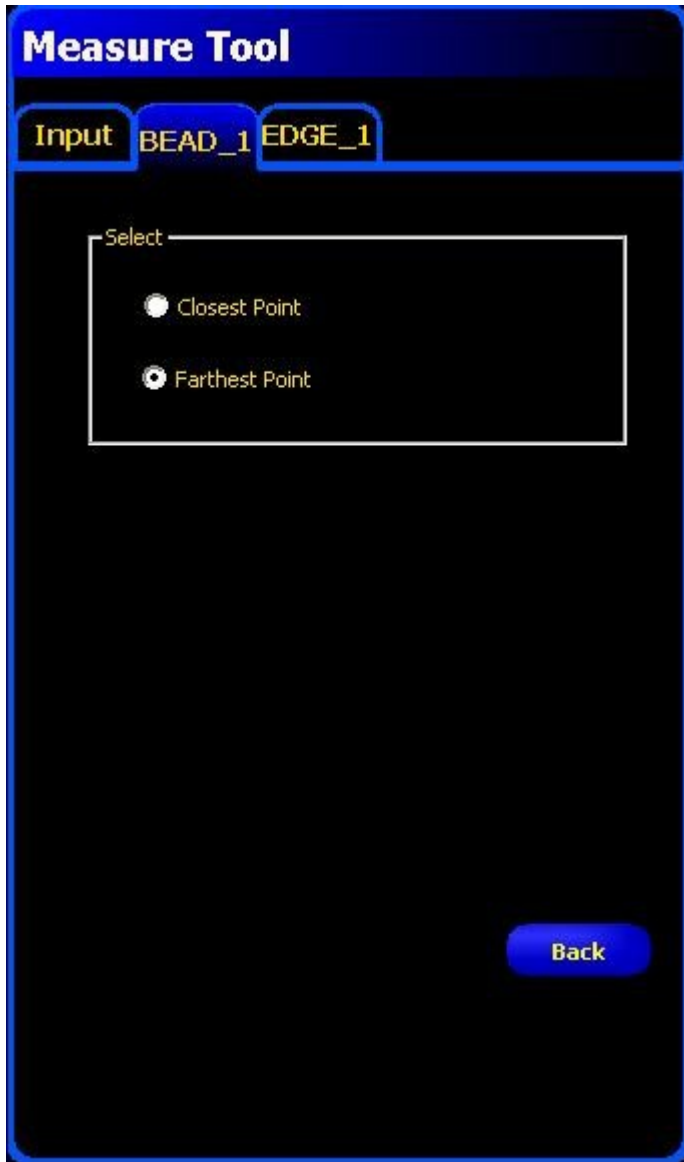

The curve, drawn in purple over the image of the bead, is an artifact generated by the bead tool. It shows the computed center spine of the bead detected by the Bead Tool within its ROI.

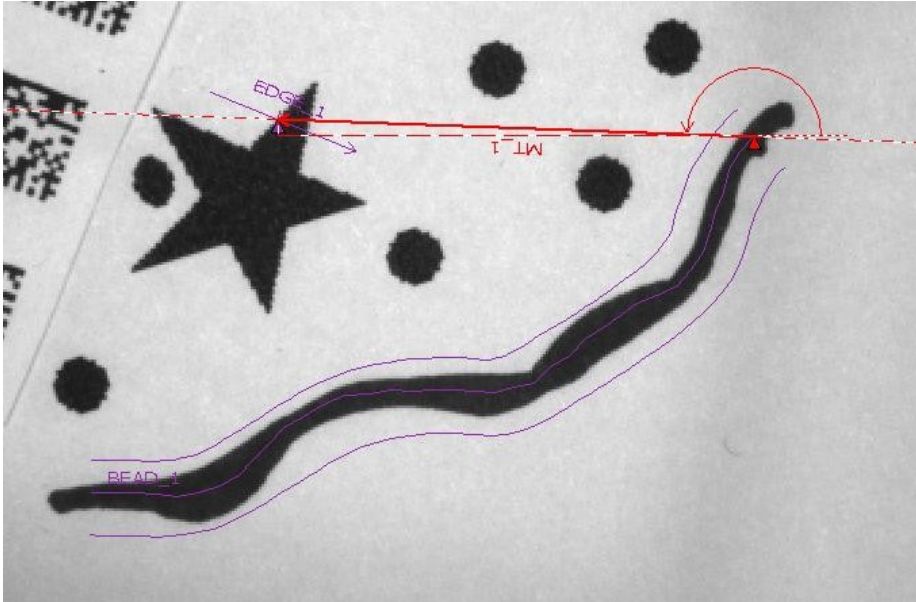

The tool returns the distance calculations for the X and Y component.

Additionally, the following results are generated in this operation:

- The line connecting the two points
- The angle of that line (relative to the x-axis)
- The coordinates of the selected (farthest or closest) point on the curve

### Measure from a Curve to a Line

This operation is available if a Bead Tool has been added to the inspection prior to the particular instance of the Measure Tool being edited. In this operation, the software calculates the distance between a curve and a line produced by other Measure Tool.

This measurement is made from either the closest or the farthest point on the curve. It is the shortest distance from the line to the selected point, and is generated by creating a line perpendicular to the original line that intersects the selected point on the curve. The points are selected in the Bead tab in the Measure Tool.

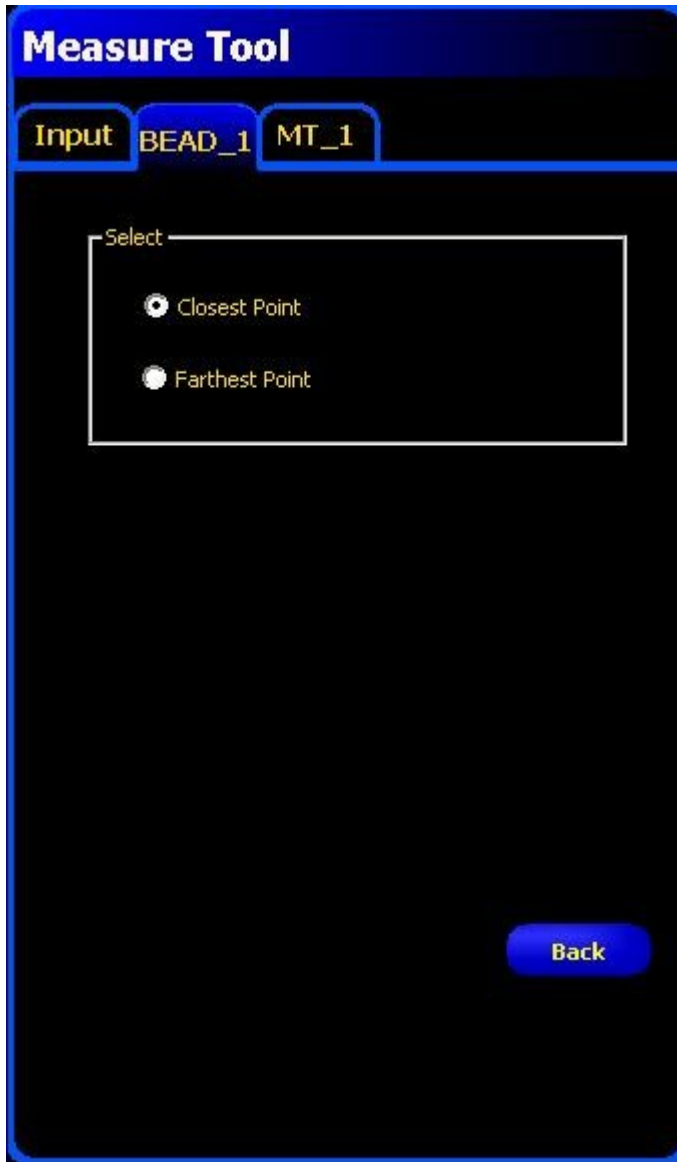

The curve, drawn in purple over the image of the bead, is an artifact generated by the bead tool. It shows the computed center spine of the bead detected by the Bead Tool within its ROI.

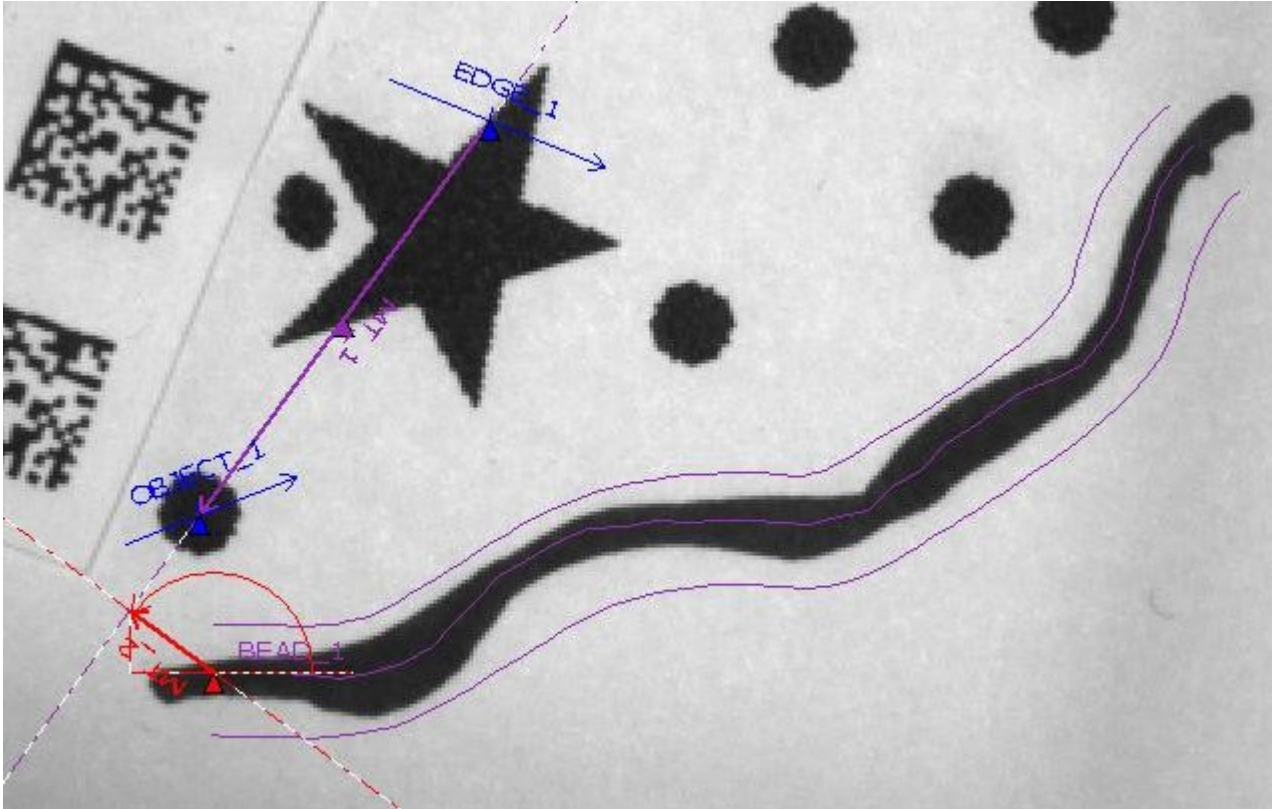

The tool returns the distance calculations for the X and Y component.

Additionally, the following results are generated in this operation:

- The line connecting the curve and the selected line
- The angle of that line (relative to the x-axis)
- The coordinates of the selected (farthest or closest) point on the curve

#### **Conventions of the Measure Tool**

The Measure tool reports an angle associated with every line it finds, according to the following conventions:

- For the line defined by two points, the tool measures the angle between the line and the horizontal plane. The tool assigned a positive or negative value to the angle, depending on the line's direction. Angles are positive if measured clockwise and negative if measured counterclockwise.

**PresencePlus Angles**

A line's angle depends on the direction of the line. The angle is  $+135^\circ$  when the line points from the upper right to lower left, but is  $-45^\circ$  if the points in the opposite direction.

- When defining the angle between two lines, the Measure tool takes into account the order of the tool inputs. The angle from Line 1 to Line 2, for example, differs from the angle from Line 2 to Line 1. The tool reports the smaller of the two angles formed where the lines intersect. The tool detects the intersection point of two lines, even if the intersection is outside of the vision sensor's field of view.

**Example Intersection Outside FOV**

The order of the input affects the angle's sign. The measure tool reports the smallest angle—in this case, it reports  $45^\circ$  instead of  $135^\circ$ .

*How the Tool Measures Two Points*

The inputs to the Measure tool for measuring two points are any two points that vision tools generate. These can be an Edge transition, a Blob centroid, or a Geo pattern. The results include the total distance between the points and the x- and y-component distances. In addition to finding these distance values, the Measure



tool also calculates the line between the two endpoints. The software reports the angle between this line and the camera's horizontal plane, as well as the coordinates for the line's midpoint.

As shown below, the Measure tool window shows the settings and results of the inspection. In the inspection image, the two points Edge\_1 and Edge\_2 define the dashed red line that runs from top left to bottom right. The actual measured distance between the points is the solid line labeled MT\_1, and the solid red triangle is the line's midpoint. MT\_1's direction is the direction of the measurement operation: from Edge\_1 to Edge\_2.

The two shorter dashed lines represent the x- and y-components. The angle between MT\_1 and the horizontal plane is the curved clockwise arrow. In the Results section of the Measure Tool window, this angle is listed as +53.11 degrees.

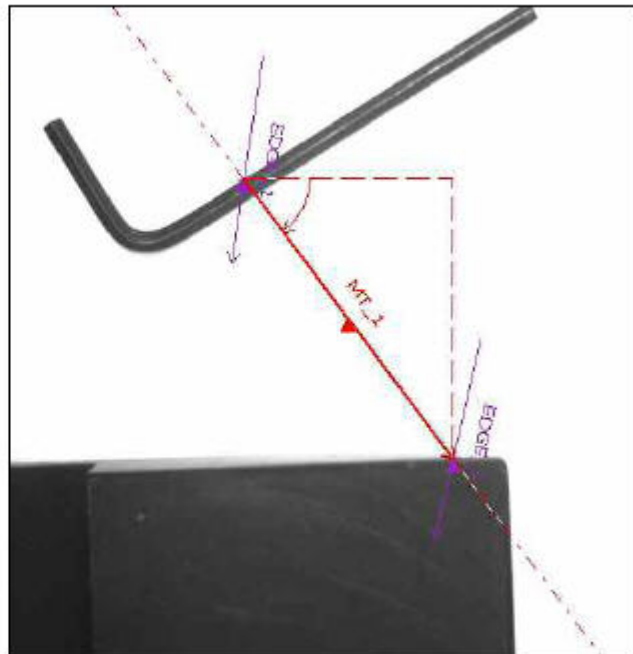
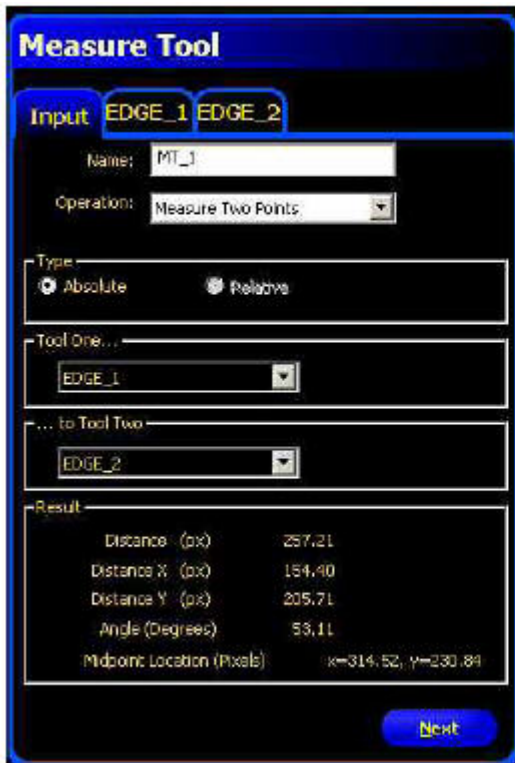

### *How the Tool Measures Two Lines*

This mode finds the angle between two lines. Both inputs are existing Measure tools. The order in which these tools are input does matter.

The intersection point can well be off the screen. This angle gives the ability to measure two lines for parallelism.

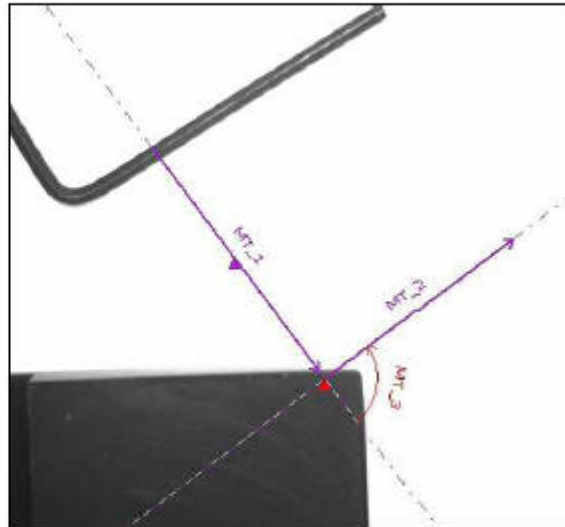

The Measure tool window to the left shows the settings and results of the inspection to the right.

The inputs are both existing Measure tools (MT\_1 and MT\_2). The output, called MT\_3, is the angle between the lines of each of the inputs. MT\_3 is a curved counterclockwise arrow from the first input, MT\_1, towards the arrowhead of the second input, MT\_2. The Results section of the measure Tool window lists this angle a -90.00 degrees. The only other piece of information reported is the intersection point of the two best fit lines, marked by a solid red triangle.

#### *How the Tool Measures a Line and a Point*

This mode finds the shortest distance between a point and a line. The two inputs to the Measure tool are:

- any point a vision tool generates
- any line another measure tool generates.

The shortest distance between a line and a point lies along another line. This new line is perpendicular to the original line, as shown below.

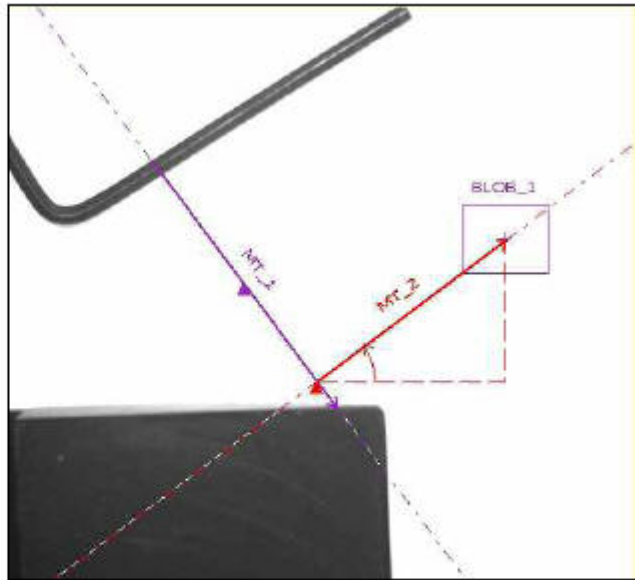
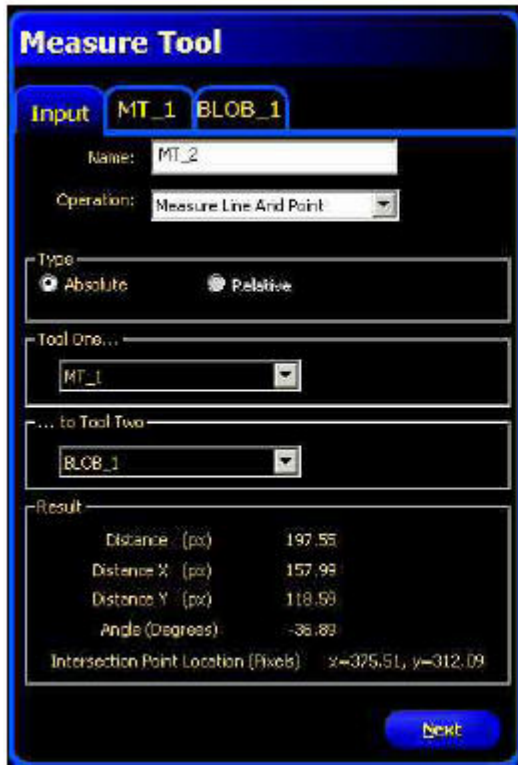

The Measure tool window to the left shows the settings and results of the inspection to the right.

In the Inspection image, the center point of BLOB\_1 and the nearest point in the input line MT\_1 define the dashed red line that runs from bottom left to top right. The actual measured distance between BLOB\_1 and MT\_1 is labeled MT\_2. The solid red triangle shows where MT\_1 and MT\_2 intersect. The Results section of the Measure Tool window lists the distance between the intersection point and the Blob midpoint as 197.55 pixels.

The two shorter dashed lines represent the x- and y-components. The angle between MT\_2 and the horizontal plane is the curved counterclockwise arrow. In the Results section of the Measure Tool window, this angle is listed as -36.89 degrees.

## Measurement Type

The PresencePLUS software can perform all three Measure tool operations using the default Absolute type or the alternate Relative type. The types differ in how the Rotation Enable feature of a one of the Location tools—Locate, Geometric Find, and Pattern Find—affect the Measure tool.



## Absolute

When the measurement type is set to Absolute, the x- and y-components of the measured distance use the absolute, or fixed, coordinate system of the camera's field of view (FOV). If a rotation enabled Location tool

precedes the Measure tool in the order of operation (that is, if the Location tool is to the left of the Measure tool in the Navigation/Results window), then the x- and ycomponent values and the angle of the line change as rotation occurs.

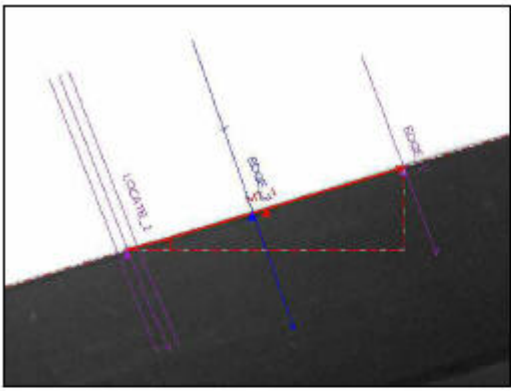

```

MT_1 Execution time = 0.1 ms
├─ Inputs
└─ Results
    ├── Success = 1
    ├── Distance = 173.90 px
    ├── Distance X = 166.40 px
    ├── Distance Y = 50.40 px
    └── Angle = -16.85 degrees
        
```

The inspection on the left shows a rotation-enabled Location tool followed by a pair of Edge tools. The results of an Absolute measurement are on the right.

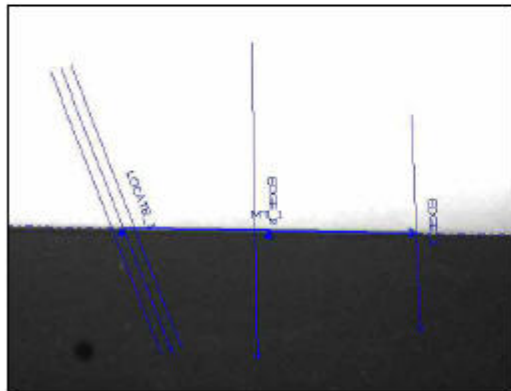

```

MT_1 Execution time = 0.1 ms
├─ Inputs
└─ Results
    ├── Success = 1
    ├── Distance = 174.30 px
    ├── Distance X = 174.30 px
    ├── Distance Y = 3.20 px
    └── Angle = 1.05 degrees
        
```

The part rotated. The x- and y-components and the angle of the measurement change, but the total distance remains the same.

### Relative

For the Measurement type to be set to Relative, a Location-type tool must precede the Measure tool in the order of operation. When the user selects the Relative type, the window indicates to what Locate tool the measurement is relative.

The coordinate system of the Measure tool changes based on the rotation information the Location-type tool provides. The x- and y-components and the angle of the measurement remain constant even if the part rotates in the camera's FOV. The relative Measure tool is relative to the rotation-enabled Locate tool. The part has rotated, but the x- and y-distances and the angle of the line are largely unaffected.

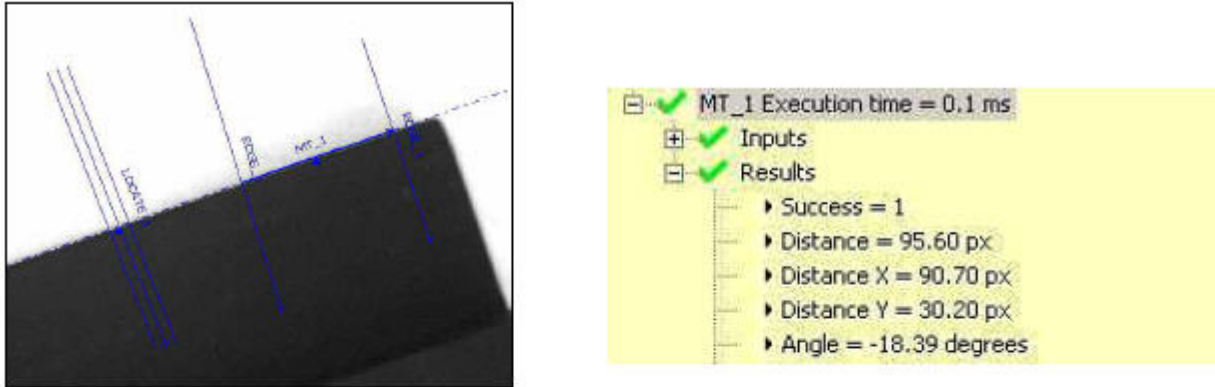

The relative Measure tool is relative to the rotation-enabled Locate tool.

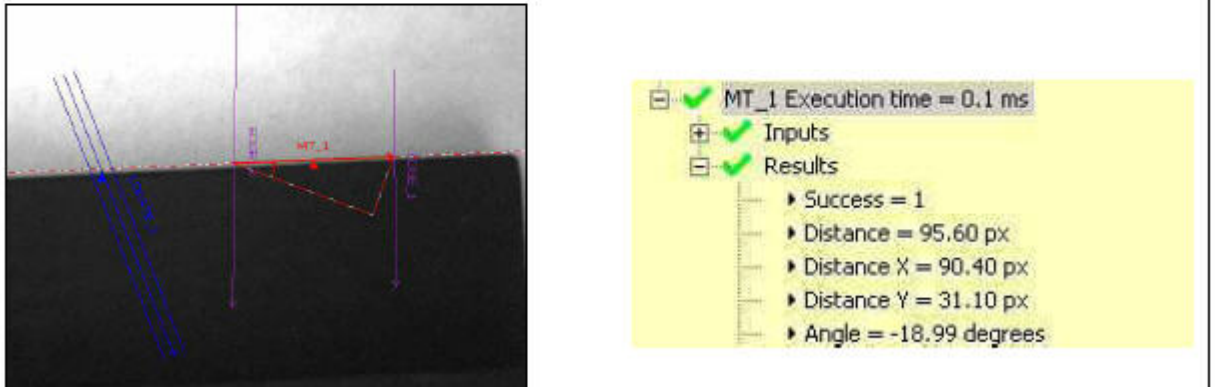

The part has rotated, but the x- and y-distances and the angle of the line are largely unaffected.

**Preserve Sign**

When this checkmark is set, the X and Y distances are computed as distance offsets. These distance offsets are represented by signed numbers. Negative numbers mean distance offset is toward the origin (0,0), positive numbers mean distance offset is away from origin.

**Additional Measure Tool Tabs**

**Measure Tool Locate Tab**

Use the drop-down list to select either to Measure From the Reference Point or the Current Point. Click [Measure Tool 7.4.4 Measure Tool](#) on page 145 for more information about the Measure tool.



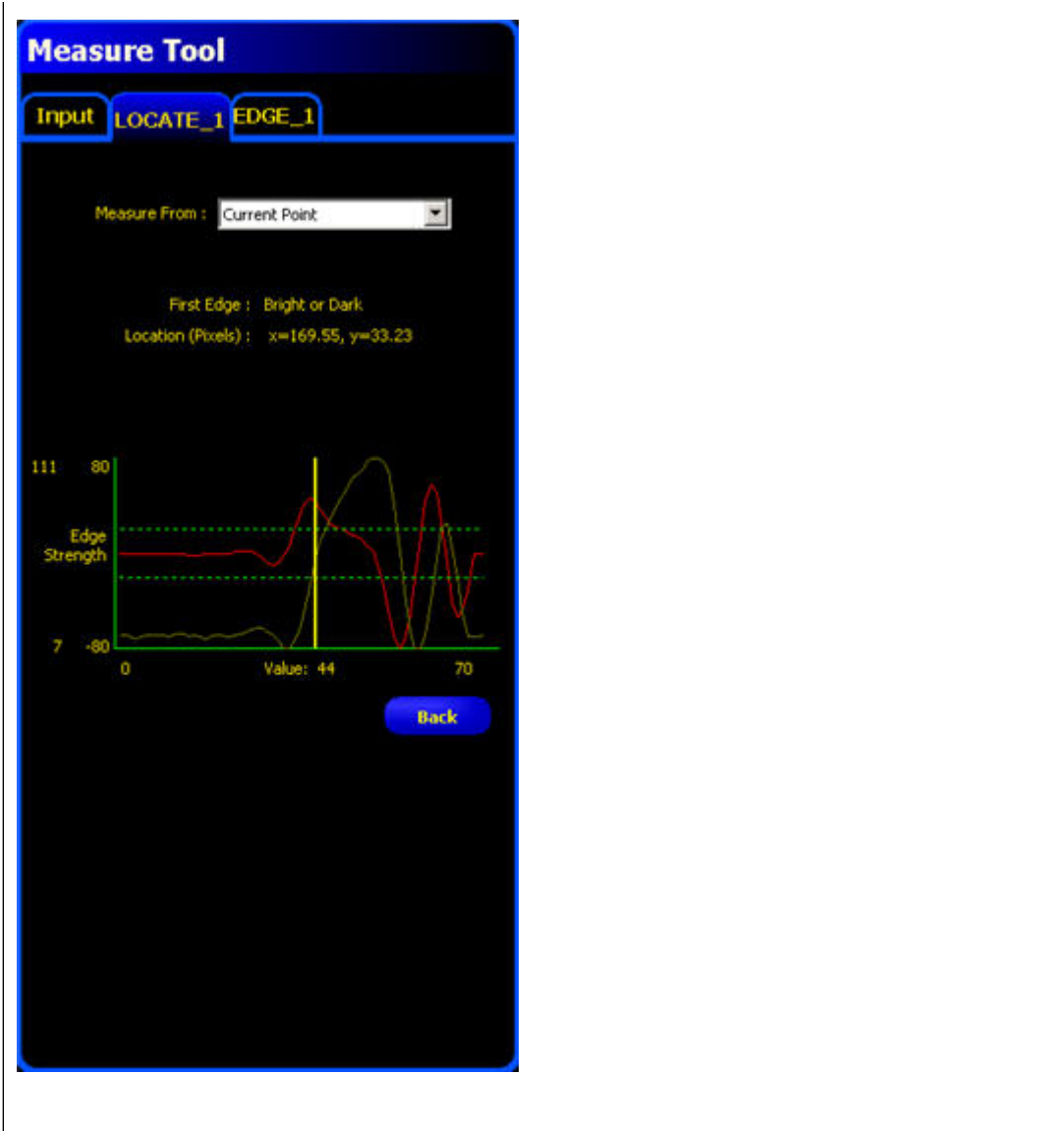

**Measure Tool Geometric Find/Count Tab**

On the Geometric Find tab, use the drop-down list to select either to Measure From the Reference Point or the Current Point.

On the Geometric Count tab, use the up or down arrow keys to select the Barcode to measure to. Click [Measure Tool 7.4.4 Measure Tool](#) on page 145 for more information about the Measure tool.

**Geometric Find and Geometric Count Tabs**

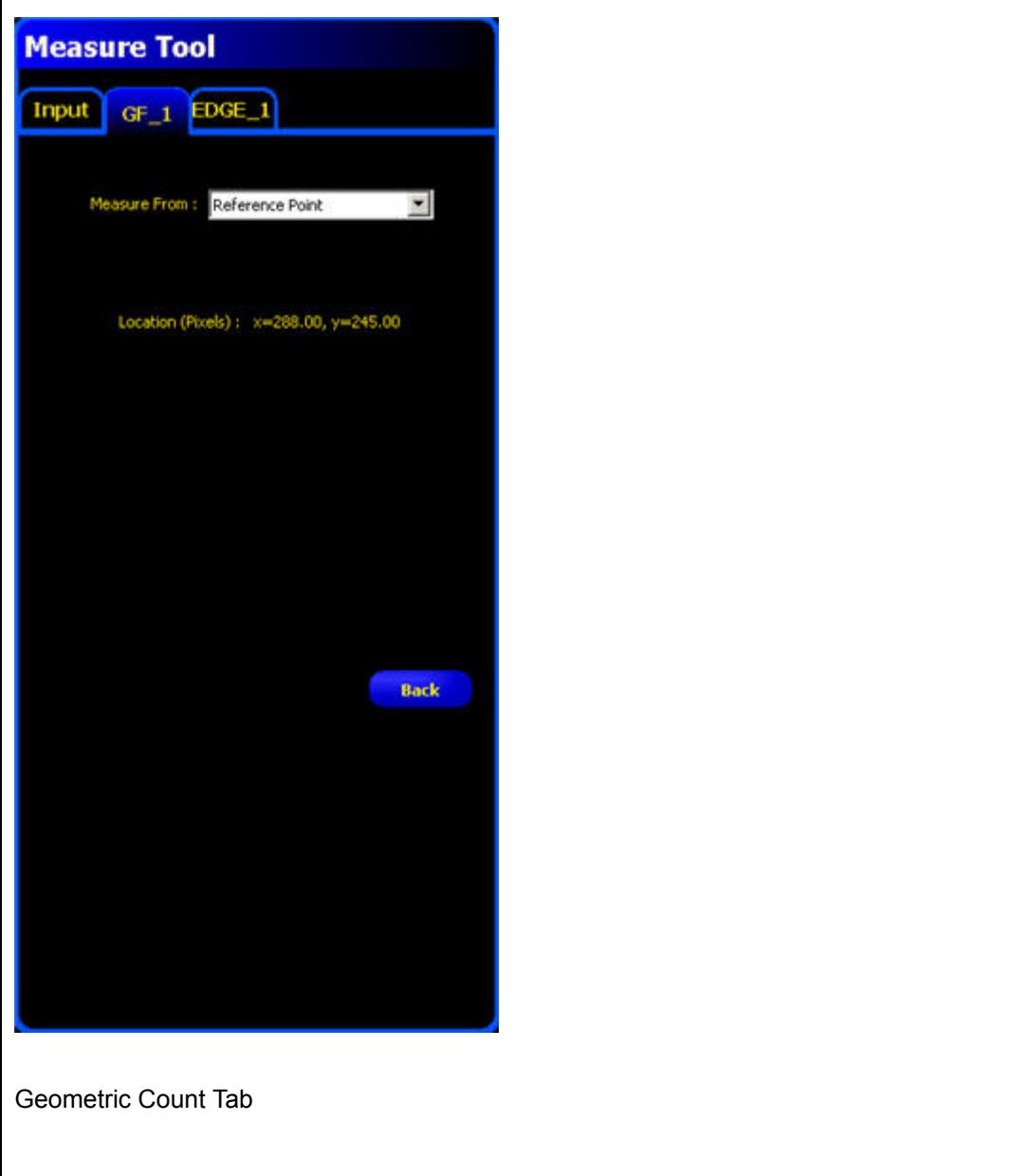

Geometric Count Tab

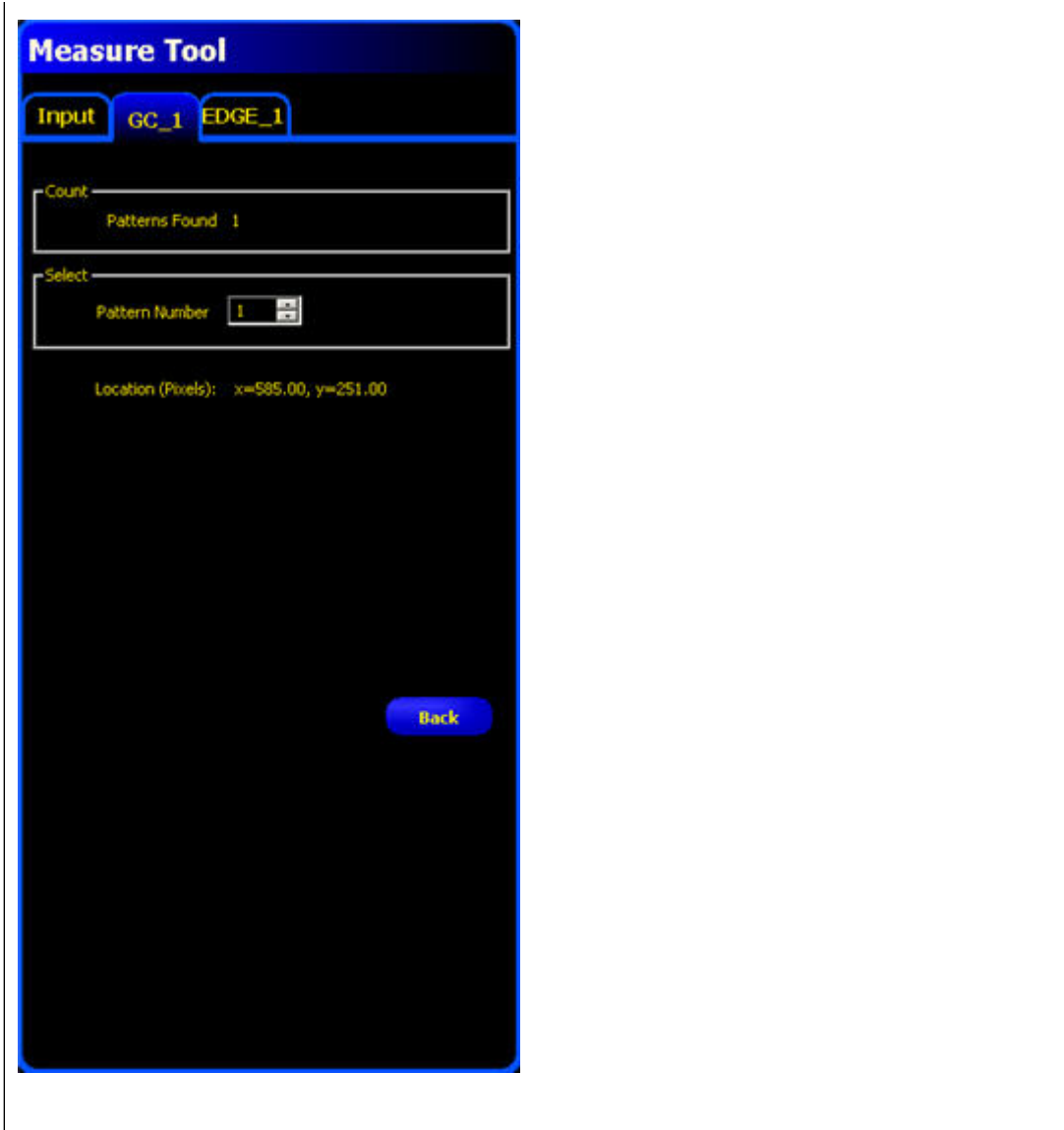

### Measure Tool Pattern Find/Count Tab

On the Pattern Find tab, use the drop-down list to select either to Measure From the Reference Point or the Current Point.

The Pattern Count tab shows the location of the Pattern Location used in the measurement. Click [Measure Tool 7.4.4 Measure Tool](#) on page 145 for more information about the Measure tool.

### Pattern Find and Pattern Count Tabs



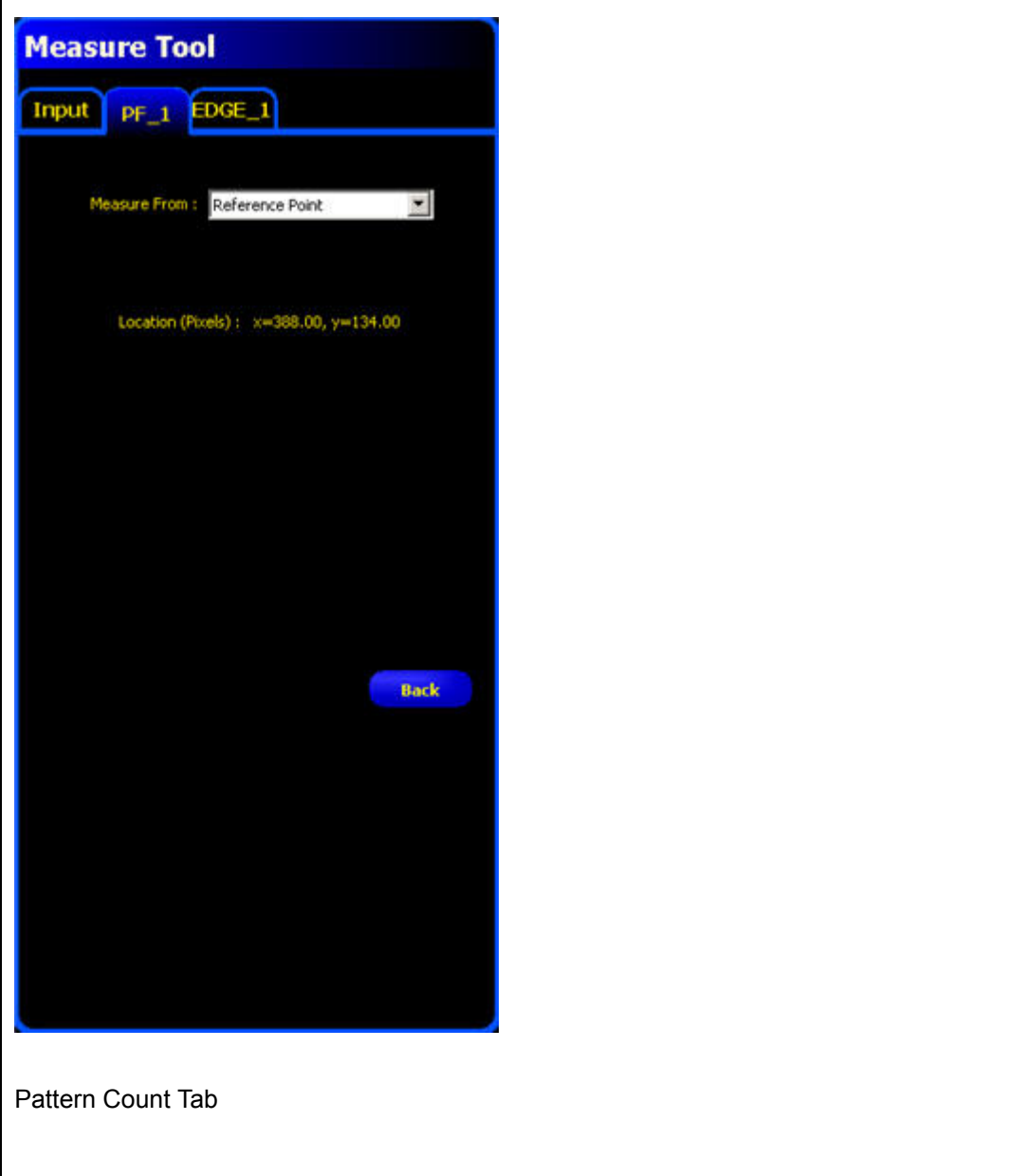

Pattern Count Tab

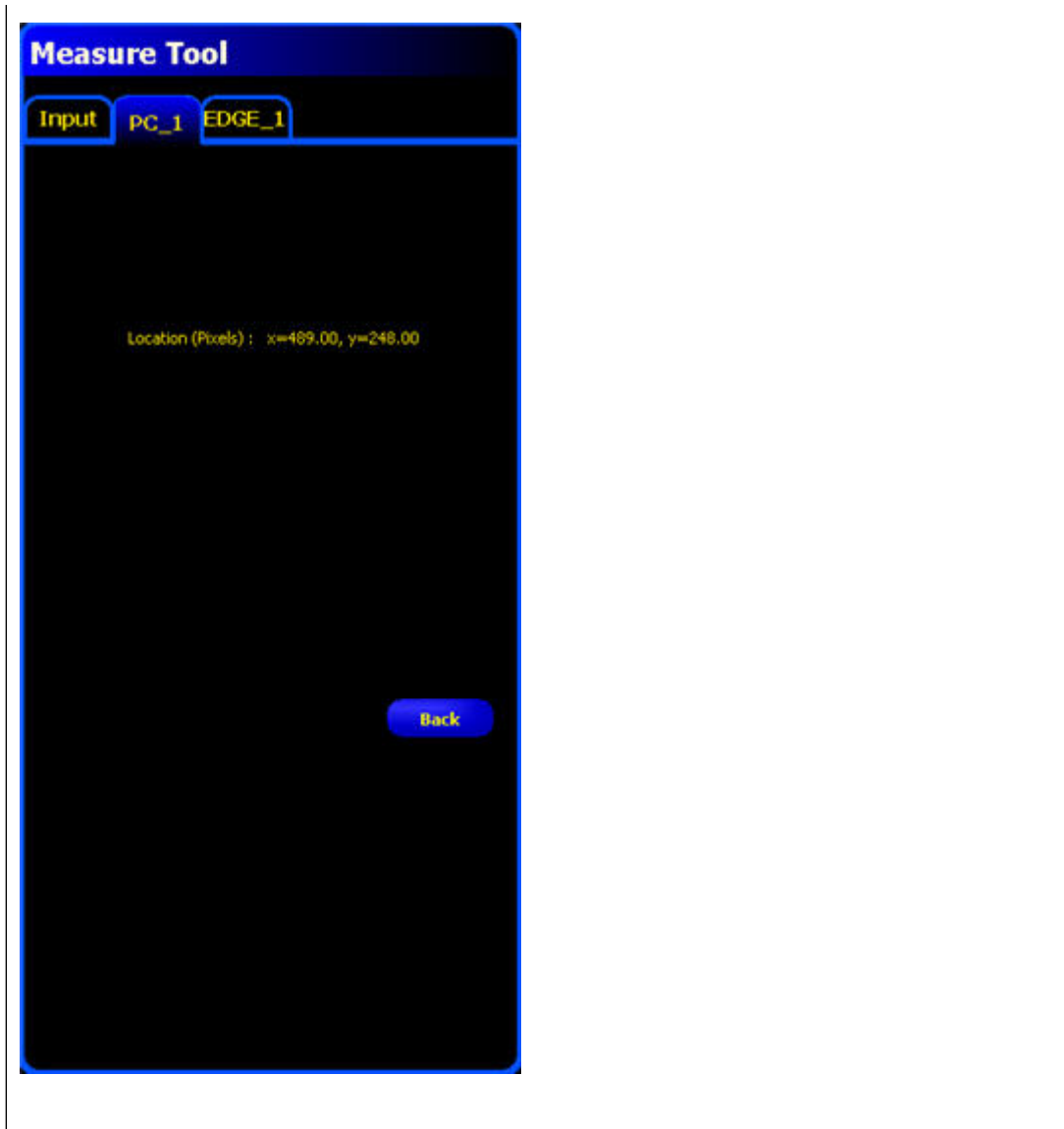

### Measure Tool Blob and Color Blob Tab

From the dropdown list select the Blob #, Smallest or Largest Blob to measure to. Click [Measure Tool 7.4.4 Measure Tool](#) on page 145 for more information about the Measure tool.

### Blob or Color Blob Tab

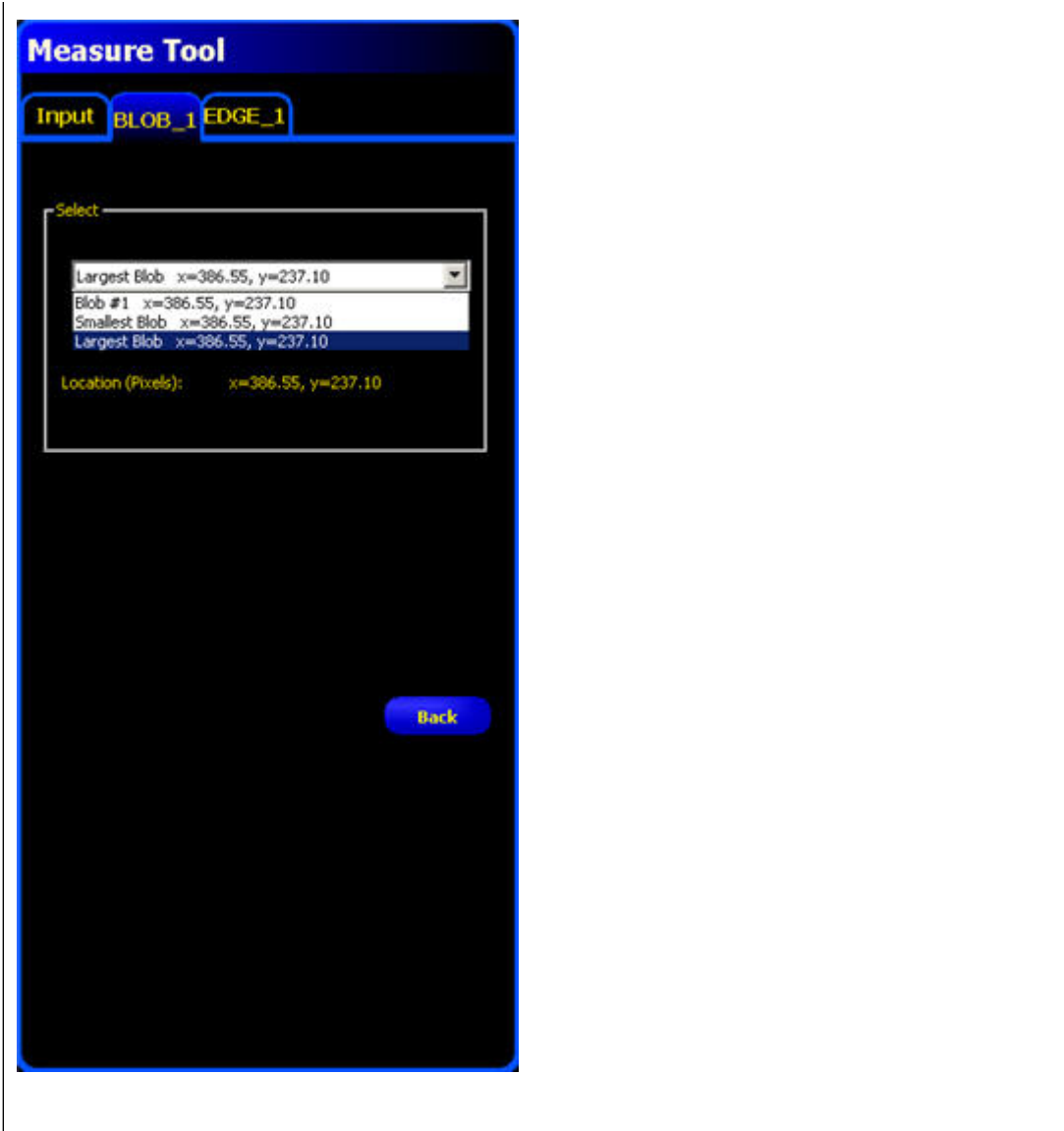

### Measure Tool Edge Tab

Use the up or down arrow keys to select the Edge Number to measure to. Click [Measure Tool 7.4.4 Measure Tool](#) on page 145 for more information about the Measure tool.

### Edge Tab

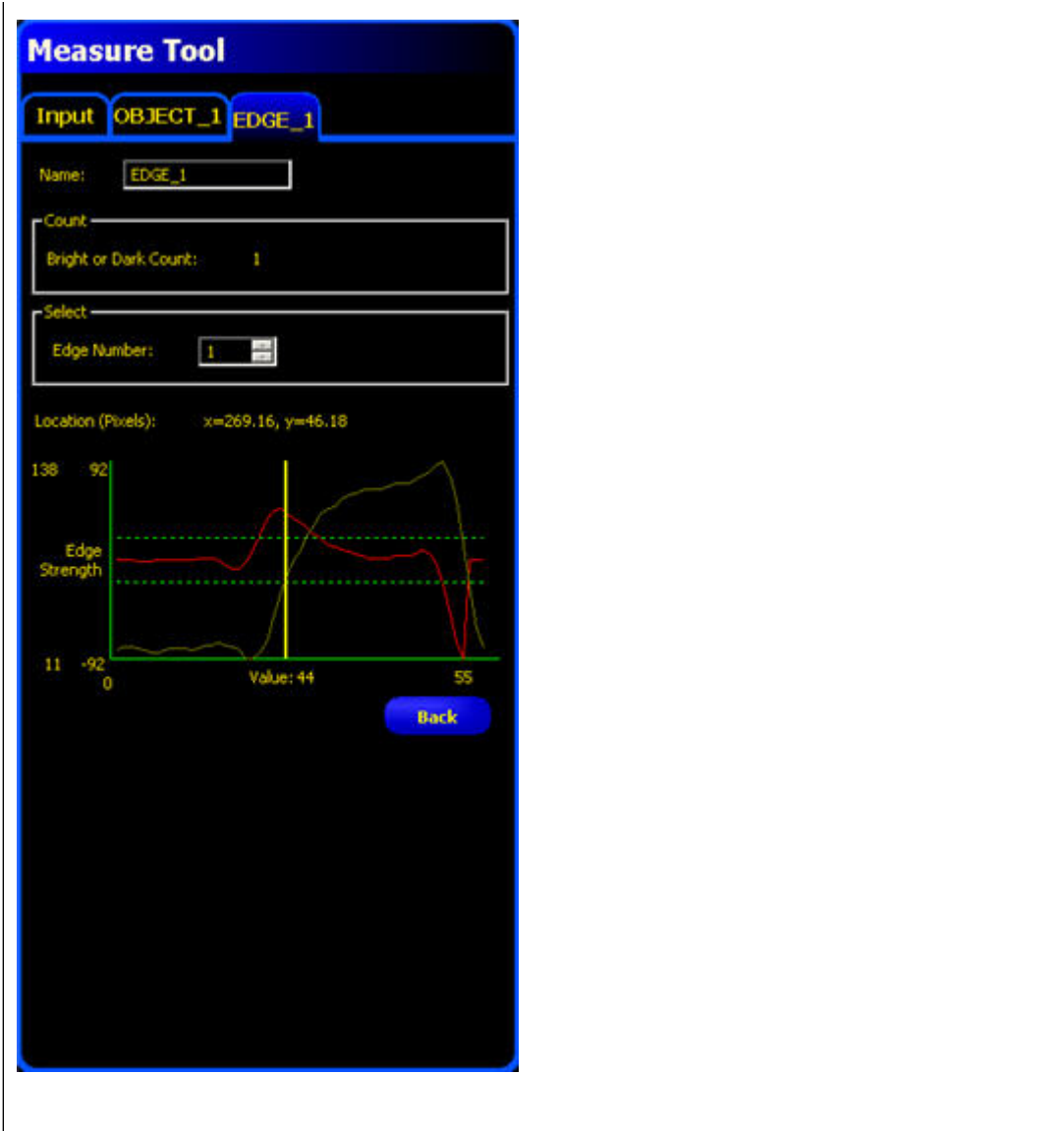

### Measure Tool Object Tab

Use the up and down arrow keys to select the Object Number to use as a point to measure to. Click [Measure Tool 7.4.4 Measure Tool](#) on page 145 for more information about the Measure tool.



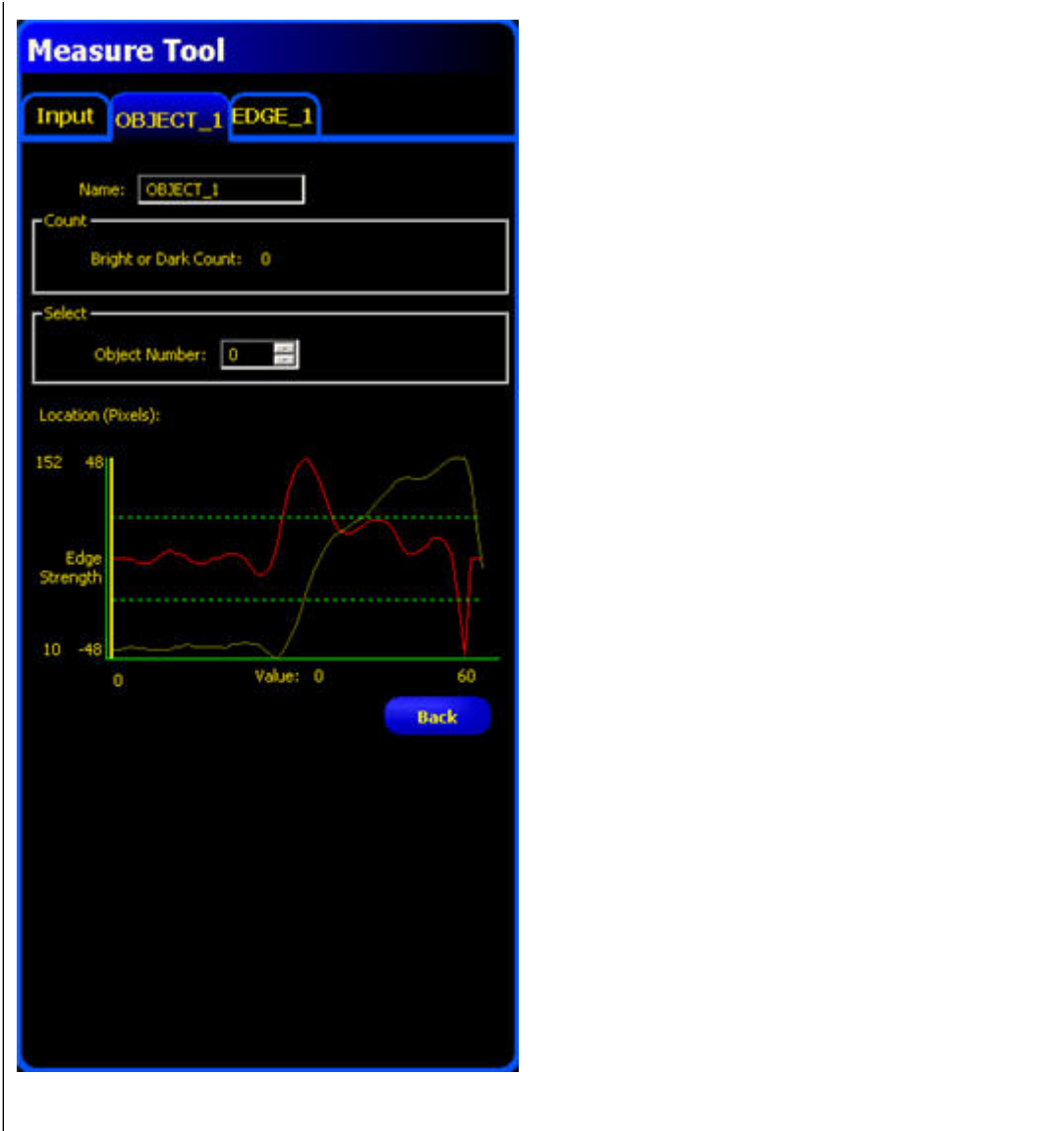

**Measure Tool Barcode Tab**

Use the up or down arrow keys to select the Barcode to measure to. Click [Measure Tool 7.4.4 Measure Tool](#) on page 145 for more information about the Measure tool.



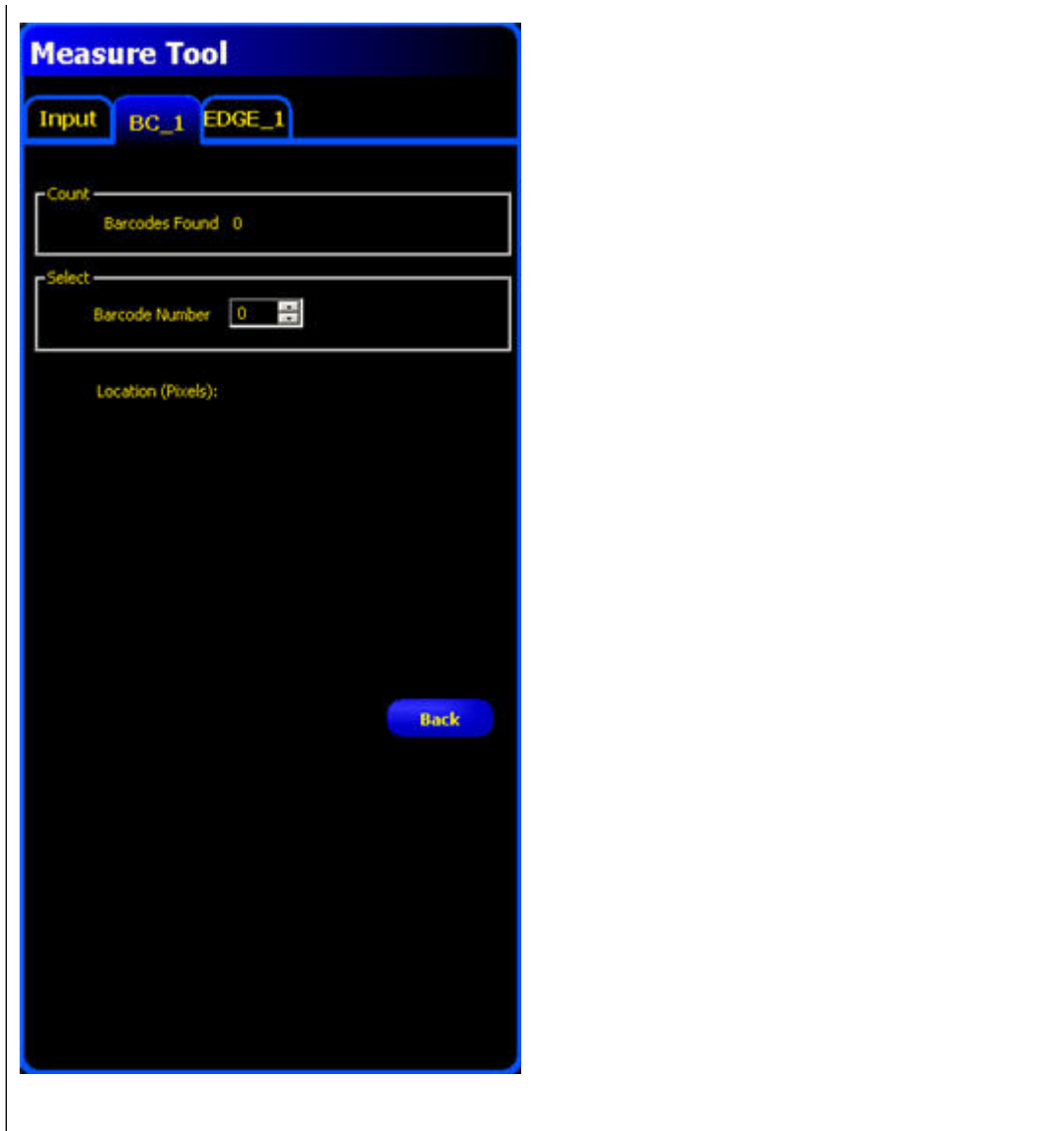

### 7.4.5 Test Tool

The Test tool uses Boolean logic to combine or convert tool results. Its data can be used to evaluate the results of a single tool or multiple tools. The output of the Test tool can be used to input to another Test tool or to generate a discrete output. Additionally, a discrete input can be tied to a Test tool.

The Test tool displays the result ranges it is using as judgement criteria. Typically, these ranges are automatically set by Quick Teach or by teaching the inspection. Additionally, they can be manually set or modified either before or after teaching or running the inspection, in which case Quick Teach will discard any manually entered values. The Test tool also displays the results of the last image evaluated while setting up or running the inspection.

For inspections with many Vision tools, the Test tools can be linked together.

#### Usage

- Gather results from image processing tools and discrete inputs
- Establish parameters for desired inspection results

- Tie multiple results together with logic options
- Include results in the overall Pass/Fail criteria
- Activate an output based on the inspection results

**Fields**

The following are fields on the Test tool Input tab:

- [Logic7.4.5.1 Logic](#) on page 168
- [Inputs7.4.5.2 Inputs](#) on page 168
- [Enabling Remote Teach7.4.5.3 Enabling Remote Teach](#) on page 169
- [Pass/Fail Contribution7.4.5.4 Pass/Fail Contribution](#) on page 169
- [Tool Tabs in the Test Tool Window7.4.5.5 Tool Tabs in the Test Tool Window](#) on page 169

**Supported Platforms**

ProII Color	ProII/ProII 1.3	OMNI Color	OMNI/OMNI 1.3	AREA/AREA13	EDGE/EDGE 1.3	GEO/GEO 1.3	BCR/BCR 1.3
Yes	Yes	Yes	Yes	Yes	Yes	Yes	Yes

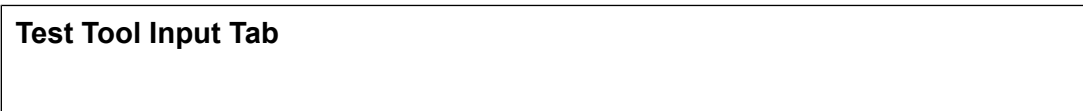

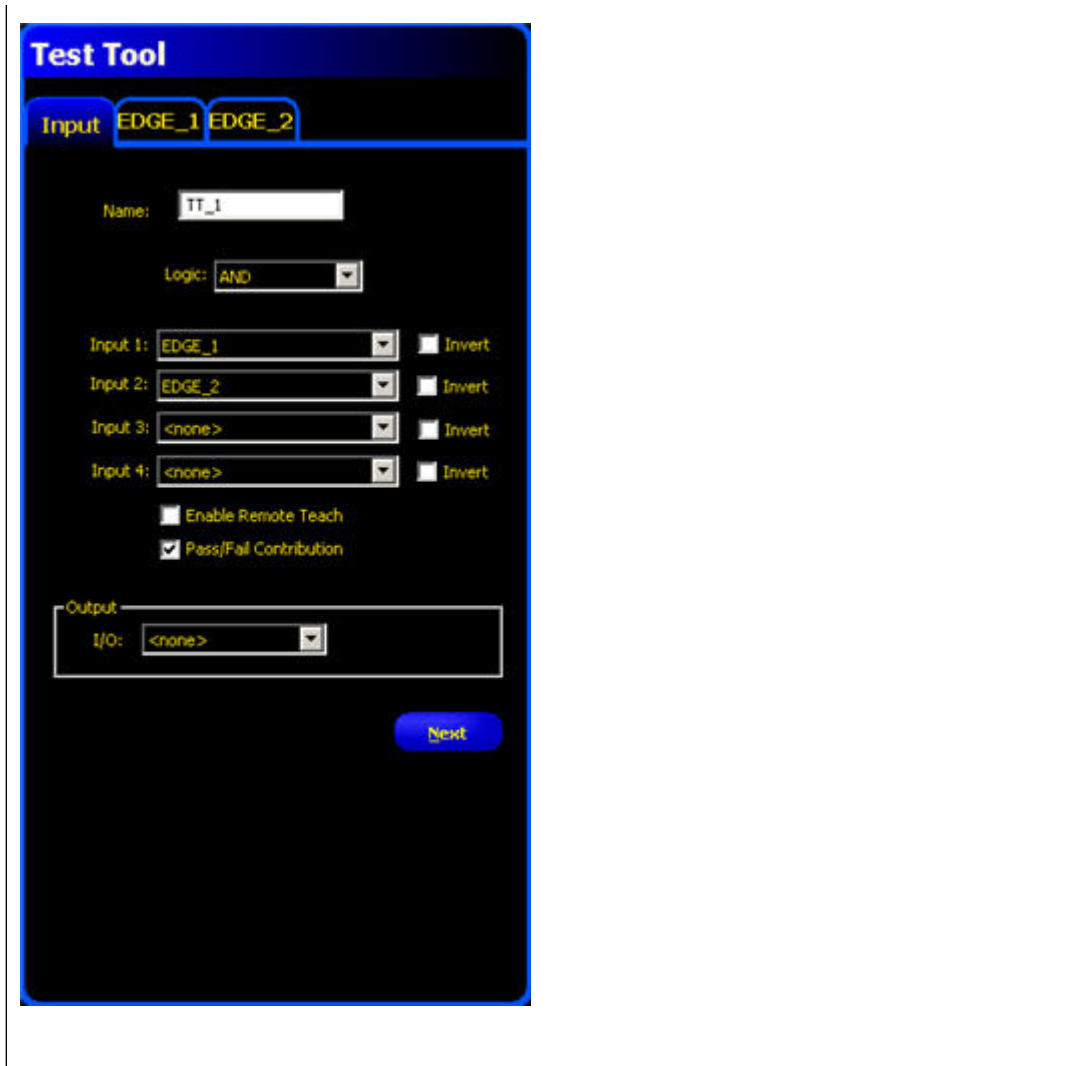

**Logic**

Use logic to combine multiple inputs to the Test tool. The results at the inputs and the logic option selected will determine whether the Test tool is True or False.



**Inputs**

Choose previous tools or external inputs that need to be evaluated to pass the Test tool. When a tool is chosen, another tab pops up in the Test tool window.





 **Note:** The tool to be evaluated must appear before the Test tool in the Navigation window.

Select Invert to invert the individual input. If the input is True, Invert reverses it to False. If the input is False, Invert reverses it to True.

### Enabling Remote Teach

The Remote Teach function is a method of remotely updating inspection parameters in Run mode. Vision tools and Test tools can be selected to be taught or not taught. To remotely teach an inspection, the Remote Teach function must be enabled on each tool to be taught.

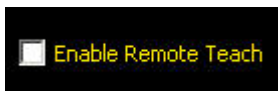

### Pass/Fail Contribution

Check this box if the Test tool will influence the Pass/Fail status of the inspection. Do not check this box if the overall Pass/Fail status of the inspection is not dependent on the current Test tool. The Pass/Fail contribution influences the following:

- Discrete output Pass
- Discrete output Fail
- Pass/Fail results counter
- Pass (Green) and Fail (red) LEDs on the Sensor
- Freezing an image on the video monitor
- Display options on the PC



### Tool Tabs in the Test Tool Window

For each tool selected in the Input tab as Input 1, 2, 3, or 4, the software displays a tab.

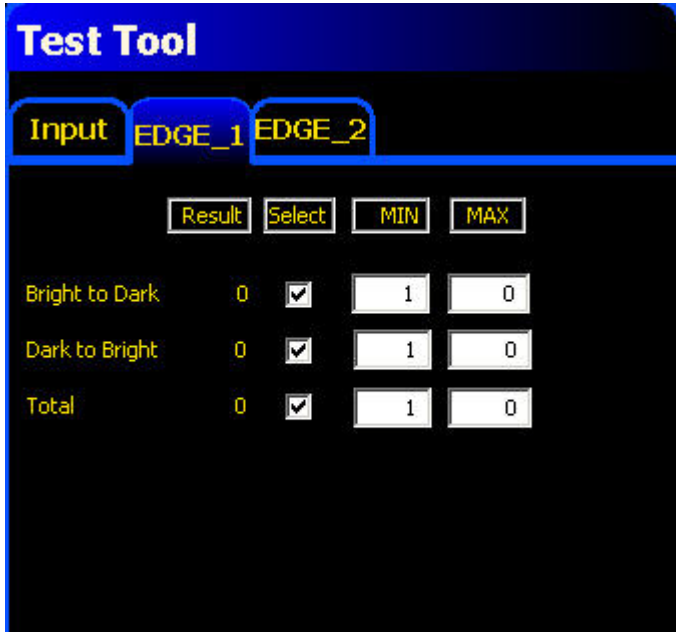

**Tool Options**

Tool	Values	Options
Locate	Not Available	
Pattern Find	Not Available	
Geometric Find	Not Available	
Average Gray Scale	Average Gray Scale	Min/Max/Tolerance % *
BLOB	Count	Min/Max
	Largest Area	Min/Max/Tolerance % *
	Smallest Area	Min/Max/Tolerance % *
	Total BLOB Area	Min/Max/Tolerance % *
Edge	Bright-to-dark (edge count)	Min/Max
	Dark-to-bright (edge count)	Min/Max
	All (edge count)	Min/Max
Object	Count <ul style="list-style-type: none"> <li>• Bright object</li> <li>• Dark object</li> <li>• All (bright or dark)</li> </ul>	Min/Max
	Width (pixels) <ul style="list-style-type: none"> <li>• Bright</li> <li>• Dark</li> </ul>	Min/Max
Geometric Count	Match count	Min/Max

Tool	Values	Options
Measure	Distance Distance X Distance Y	Min/Max/Tolerance % *
Test	True/False value	Pass/Fail Contribution
Communication	Success/Fail	Pass/Fail
Discrete Inputs 1-6	ON/OFF	
System Error	True/Fale	

**Test Tool Average Gray Scale Tab**

**Tool Options**

Values	Options
Gray Scale	Min/Max/Tolerance % *
Deviation	Min/Max /Tolerance %

**Test Tool Average Gray Scale Tab**

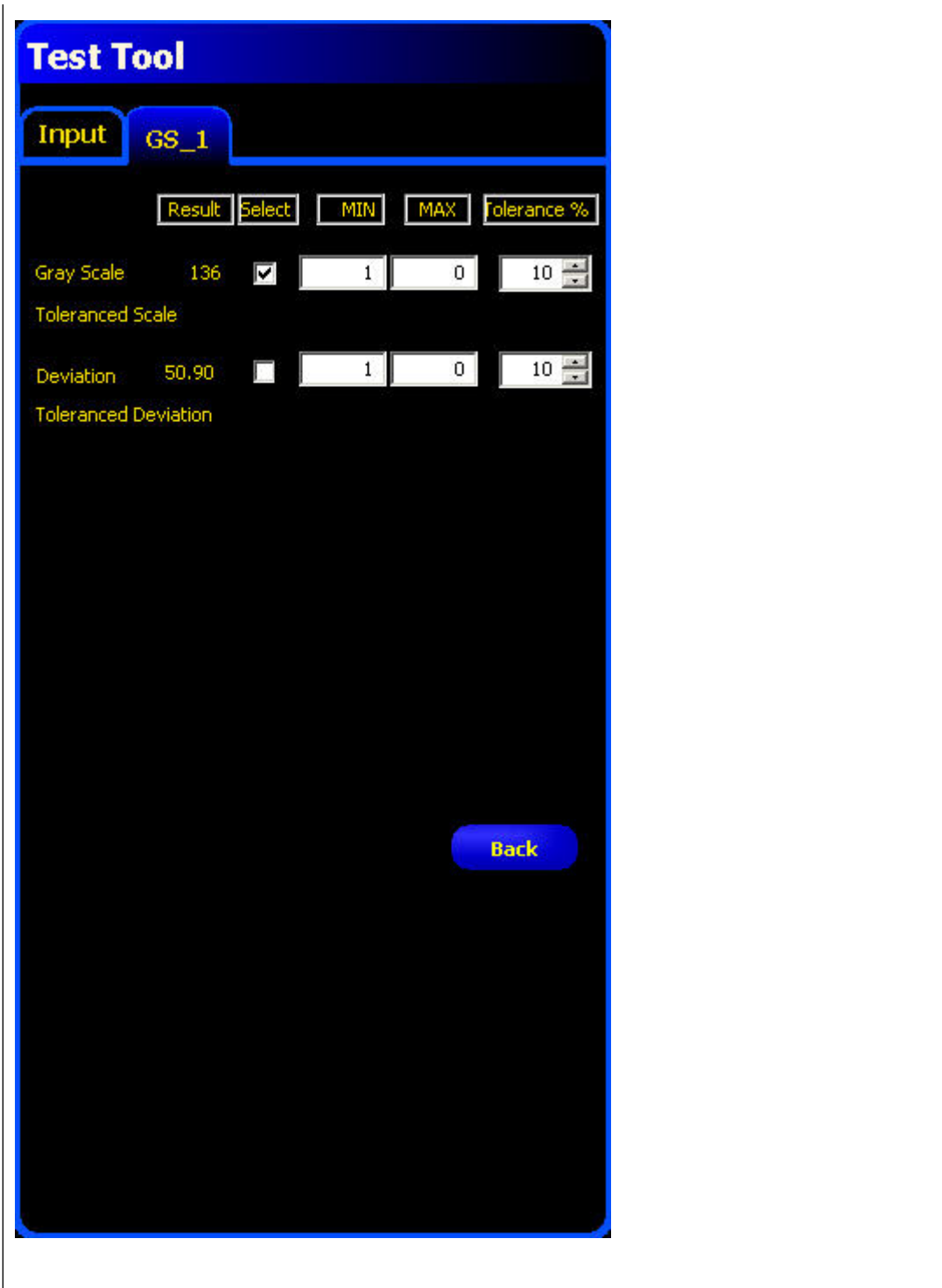

**Test Tool Blob and Color Blob Tab**

Indicates if the result is a MATCH or NO MATCH.



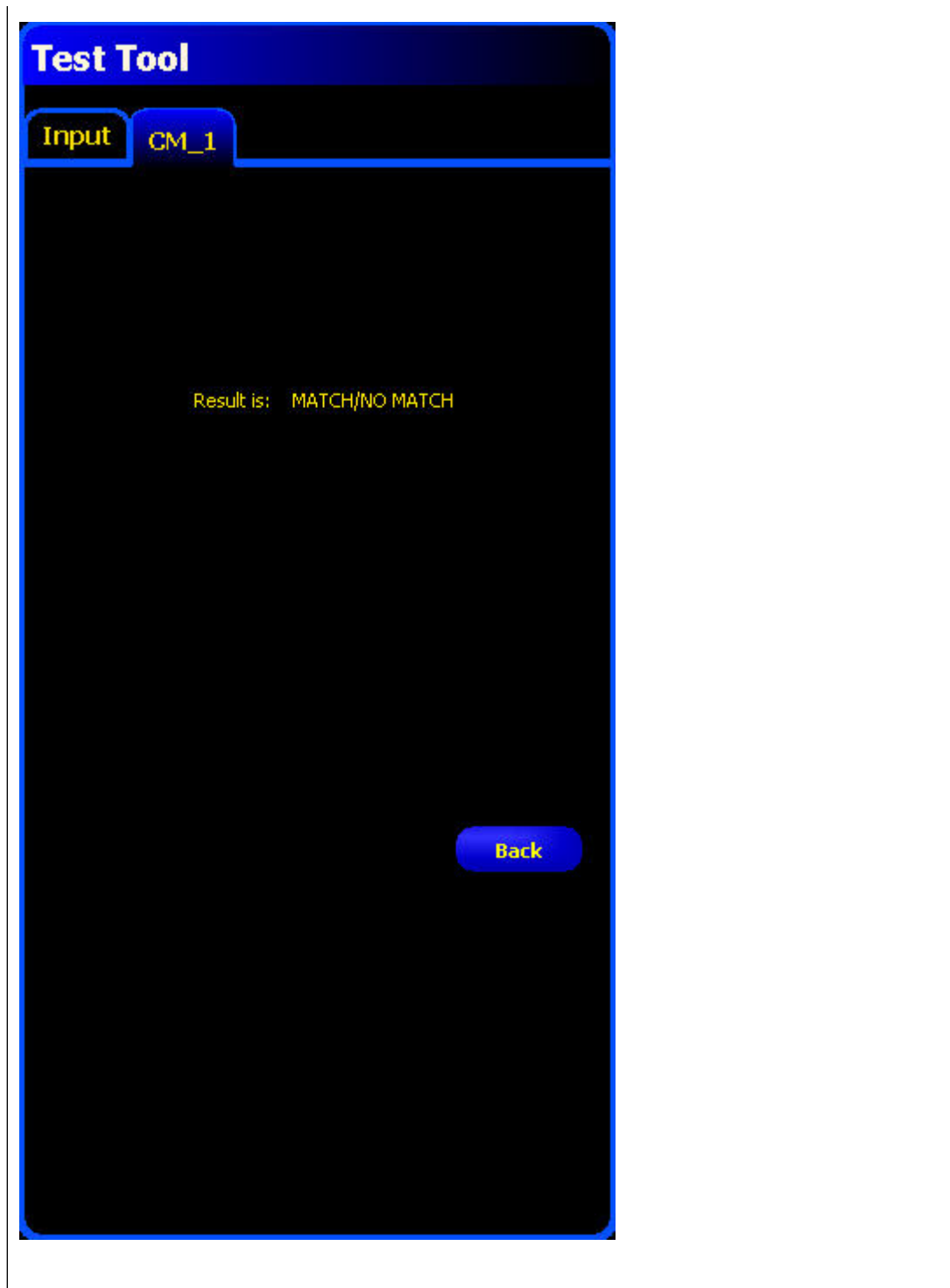

### Test Tool Edge Tab

Values	Options
Bright to Dark	Min/Max
Dark to Bright	Min/Max
Total	Min/Max



Test Tool Geometric Count Tab

Values	Options
Count	Min/Max



Test Tool Pattern Count Tab

Test	Values	Options
Match Count	Count	Min/Max

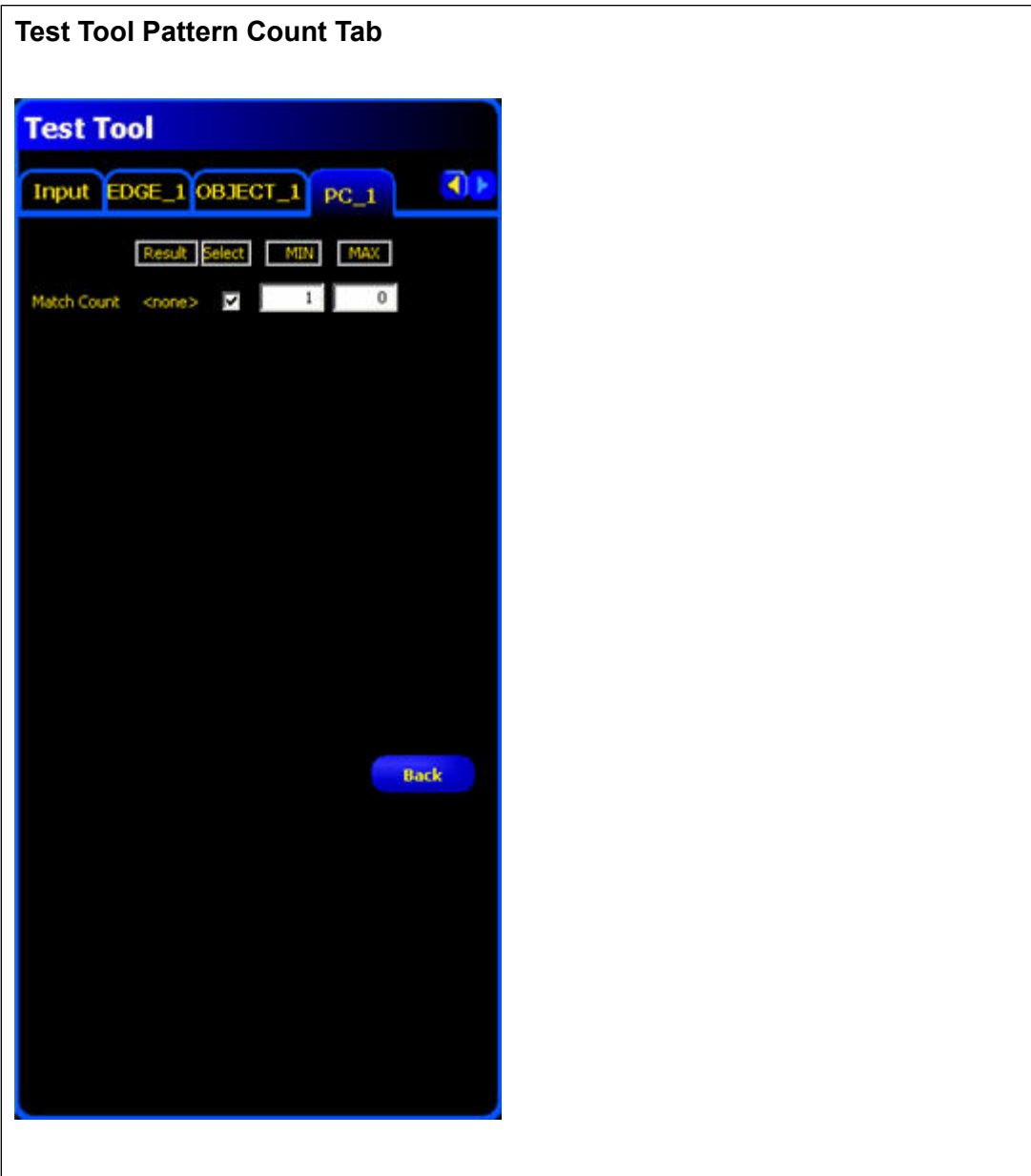

**Test Tool Object Tab**

Test	Values	Options
Count	Bright Object	Min/Max
	Dark Object	Min/Max
	Totabl Object	Min/Max
Select	Object	All
Width (px)	Object #	Min/Max/Tolerance %

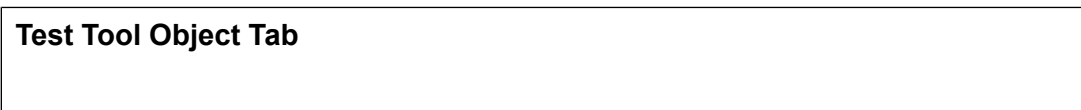



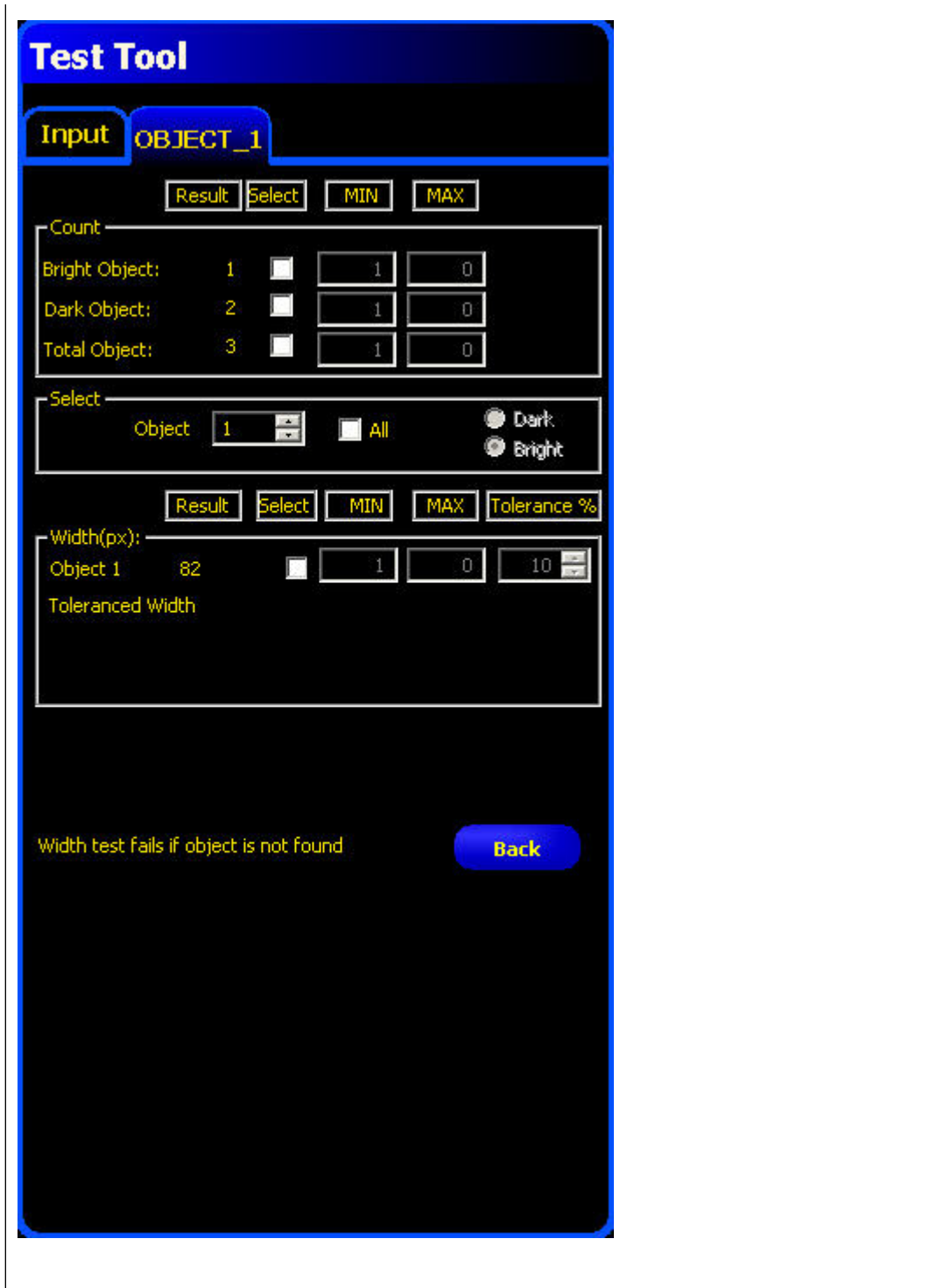

**Test Tool Average Color Tab**

Category	Values	Options
Averages	Hue	Begin/End/Tolerance %
	Saturation	Min/Max /Tolerance %
	Intensity	Min/Max /Tolerance %

Category	Values	Options
Standard Deviations	Hue	Min/Max /Tolerance %
	Saturation	Min/Max /Tolerance %
	Intensity	Min/Max /Tolerance %

**Test Tool Average Color Tab**

**Test Tool Color Match Tab**

Indicates whether there is a color MATCH or NO MATCH.

**Test Tool Color Match Tab**

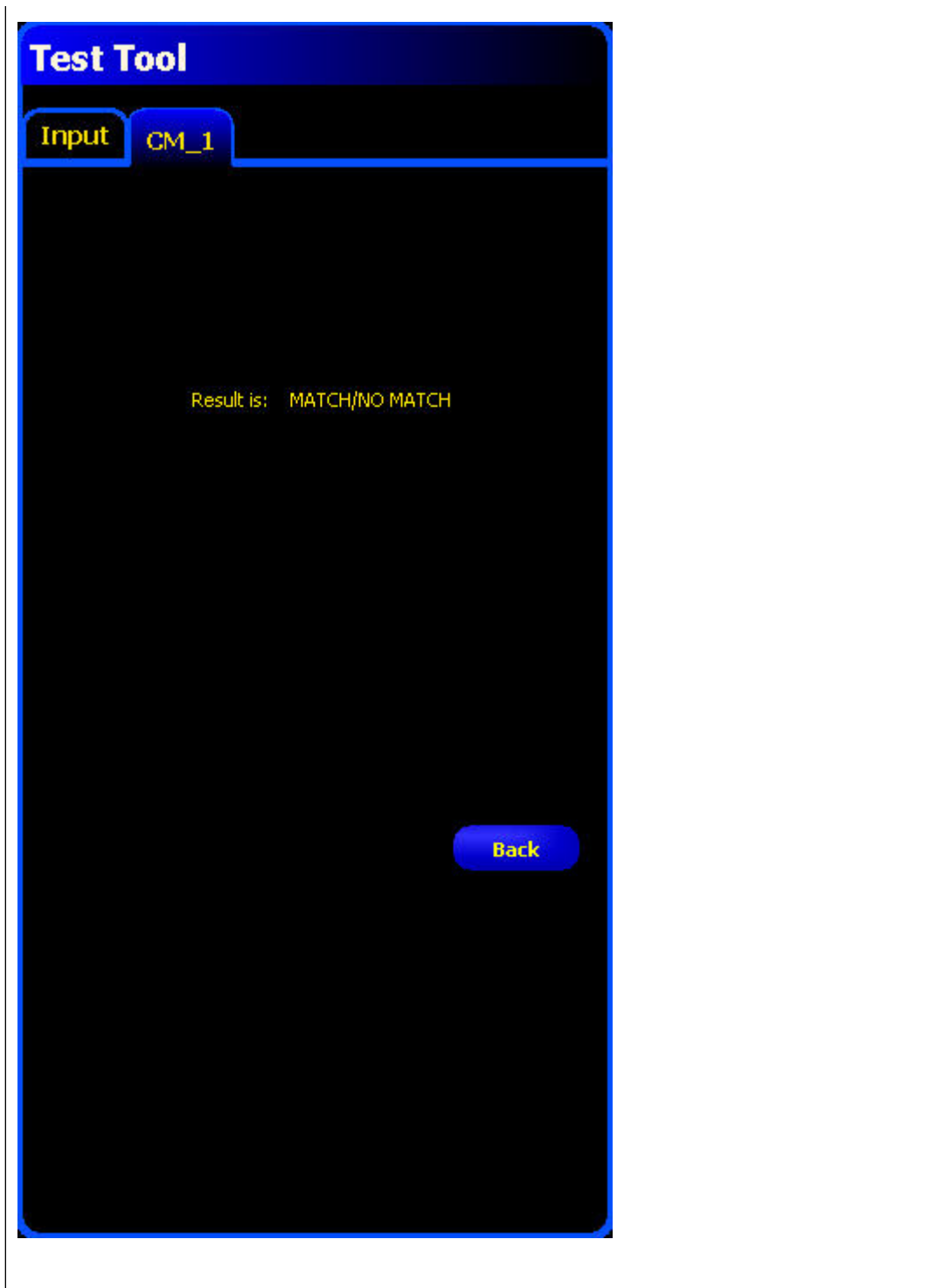

**Test Tool OCR Tab**

Test	Values	Options
String Length	Count	Min/Max
Data Read	String	



**Test Tool OCV Tab**

Indicates where the String matches or not.





**Test Tool Math Tab**

Indicates where the String matches or not.





**Test Tool Measure Tab**

Indicates where the String matches or not.





**Test Tool Test Tab**

Indicates whether the test









---

# Communication Tool Setup

To set up the Communication tool, click on the System button in the Main Menu toolbar to bring up the System Setup window, then click on the Communication tab.

## 8.1 Ethernet Connection

In order to establish an Ethernet connection, the external device must be directed to the correct IP address and the correct TCP port. In TCP/IP protocol, a TCP port number is used with the IP address to identify a specific path or socket. The sensor has sockets 1 to 10, and can send out unique sets of data to 10 different devices.

Valid user TCP/IP port numbers are in the range of 1024 through 65535. The PresencePLUS GUI provides automatic notification if you attempt to use a reserved port.

To view an Ethernet connection:

1. Click on the System button in the Main Menu toolbar to bring up the System Setup window.
2. Click on the **Communication** tab.

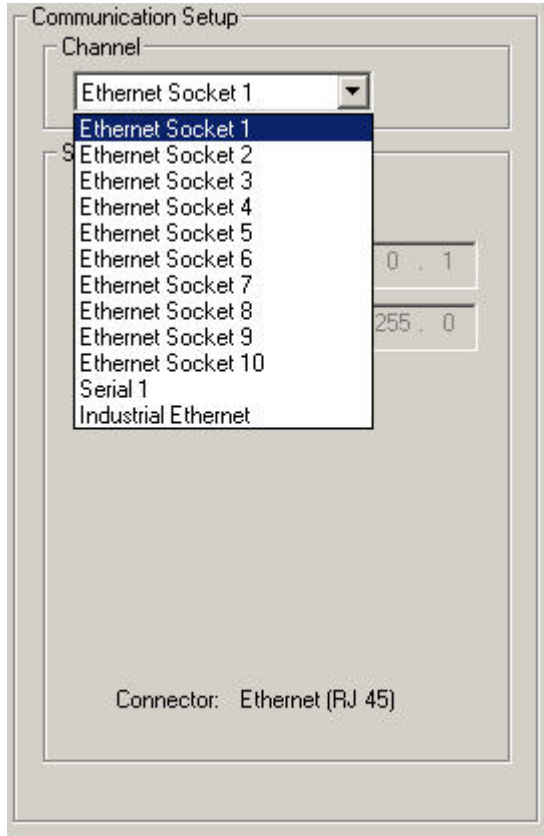

3. Choose a connection from the fixed Connection drop-down list of the **Communication Tool Setup** field.

Each Ethernet socket has a unique TCP port number as shown below

 **Note:** The following addresses are defaults.

Socket	Default IP Address	Port
1	192.168.0.1	20000
2	192.168.0.1	20001
3	192.168.0.1	20002
4	192.168.0.1	20003
5	192.168.0.1	20004
6	192.168.0.1	20005
7	192.168.0.1	20006
8	192.168.0.1	20007
9	192.168.0.1	20008
10	192.168.0.1	20009

## 8.2 Serial Connection

The sensor has a single serial connection that you can configure, Serial 1:

- Serial 1 is the DB-9 connector.

 **Note:** The Pro has 2 serial connections. Serial 2 in the dropdown list is to support those sensors.

The sensor has one serial connection that can be configured: Serial 1 is pins 1, 9, and 10. Set up the serial communication options to match the receiving device. The following table shows the configuration options:

Attribute	Default Setting
Baud Rate	115200
Data Bits	8
Parity	None
Stop Bit	1
Flow Control	None

To setup a serial connection:

1. Click on the **System** button in the Main Menu toolbar to bring up the System Setup window.
2. Click on the **Communication** tab.
3. Choose Serial 1 from the Connection drop-down list of the **Communication Tool Setup** field.

Communication Setup

Channel

Serial 1

Settings

Baud Rate: 115200

Data Bits: 8

Parity: None

Stop Bits: 1

Flow Control: None

Connector: Serial

 **Note:**

Because there is no flow control for the serial connections, the sensor will not detect or log a lost or broken connection

## 8.3 Overview of Testing the Communication Tool

1. Connect the Sensor to a PC using a crossover Ethernet cable (STPX. ) or the serial pins on the Sensor cable.
2. Start an inspection that has a configured Communication tool. For details about configuring the Communication.
3. Start HyperTerminal or Telnet.
4. Trigger the Sensor.
5. Look in HyperTerminal or Telnet to see if the data has updated.

## 8.4 Detailed Steps for Testing the Communication Tool

There are a number of software programs such as Telnet and HyperTerminal that can test the connection with the Communication tool.

- Telnet can test Ethernet communications and is relatively easy to set up.
- HyperTerminal can test both serial and Ethernet communications, but note that HyperTerminal for Windows NT does not have an Ethernet option.

### 8.4.1 Testing Ethernet Communications

To test Ethernet communications with Telnet:

1. Start an inspection that has a configured Communication tool.
2. Connect a PC to the controller using an Ethernet crossover cable.
3. From the Start menu, click Start > Run.
4. In the dialog box, type:

```
telnet controller_ip_address ip_port
```

Example: telnet 192.168.0.22 20000

5. Click **OK** to open a Telnet window.
6. Trigger the sensor.
7. View the results.

To test Ethernet communications with HyperTerminal:

1. Start an inspection that has a configured Communication tool.
2. Connect a PC to the controller using an Ethernet crossover cable.
3. Start a new connection with HyperTerminal.
4. Connect using TCP/IP (Winsock).
5. Configure HyperTerminal to talk with the controller. For example:
  - Host Address: 192.168.0.1
  - Port Number: 20000 (Ethernet Socket 1)

6. Trigger the sensor.
7. View the results.

### 8.4.2 Testing Serial Communications

To test serial communications with Telnet:

1. Start an inspection that has a configured Communication tool.
2. Connect a PC to the sensor using a serial cable.
3. Start a new connection with HyperTerminal.
4. Connect using COM1 (choose a serial COM port).
5. Configure HyperTerminal to talk with the sensor. For example:
  - Baud rate = 1155200 bits/sec (sensor default).

- Data bits = 8 (sensor default)
  - Parity = None (sensor default)
  - Stop Bits = 1 (sensor default)
  - Flow Control = None
6. Trigger the sensor.
  7. View the results.

## 8.5 Troubleshooting Ethernet Connections

1. Check the LEDs on the sensor's RJ-45 connector.
  - No LEDs are ON: the cable may not be the correct type (straight or crossover), or it could be broken.
  - Only the yellow LED is ON: the electrical connection is good, but the sensor device are not exchanging data.
  - Yellow LED is ON and the green LED is ON or flashing: data are being exchanged between the PC and the sensor.
2. Verify that the Communication tool is configured correctly.
  - The connection should be Ethernet socket 1 - 10.
  - Verify that you have selected the desired result data in the **Tool** tab.
3. Check the receiving device setup.
  - Check the IP address. The device IP subnet must match the sensor IP subnet.
  - Check the Port number: 20000 - 20009 (not 2000).
  - Check all firewall and anti-virus software to verify that it is not blocking the sensor's Ethernet socket.

## 8.6 Troubleshooting Serial Connections

1. Verify the hardware.
  - Check for breaks in the serial cable.
  - Use a straight serial cable from the sensor to the PC.
2. Verify that the Communication tool is configured correctly.
  - Verify that the desired result data has been checked.
3. Check the receiving device setup.
  - Check the receiving device setup.
  - Check that the COM port properties on the receiving device matches the System parameters in the sensor (baud rate, data bits, parity, stop bits, and flow control).



## 8.7 Remote Command Channel Configuration

This section describes the commands that are supported to communicate with a Vision sensor. All commands are case-insensitive

### 8.7.1 Remote Command Set

All RCC commands are case-insensitive. Valid characters for commands are 7-bit ASCII alphabetic or numeric characters (A-Z, a-z, 0-9), dash (-) and underscore (\_).

All commands have the following structure:

*ACTION OBJECT\_IDENTIFIER QUALIFIER(S)*

*ACTION* is an operation the user intends to perform on the *OBJECT\_IDENTIFIER*. There are three possible actions available:

- **GET** — used to retrieve information associated with the named object. This information can be a Boolean value, and unsigned or signed number, a string or, for complex objects like the Communications tool, a field-delimited record that includes other data types.
- **SET** — used to assign a value to a named object.
- **EXEC** — used to execute a pre-defined functional object or activity in the sensor. Activities may take object identifiers as parameter qualifiers.

The table below identifies objects that are supported in the current RCC release, their identifiers, and the corresponding actions that they will support. Items highlighted in bold are command keywords. Flag objects are appended with the **FLG** suffix, status objects are appended with the **STS** suffix, and counters are appended with the **CNT** suffix.

System Object, Component, or Activity	Object or Activity Identifier	Support Actions	Required Qualifiers	Optional Qualifiers	Comments
Trigger	<b>TRIGGER</b>	<b>EXEC</b>	None	Timeout (msec) or <b>NOWAIT</b>	If no qualifiers are specified, a 30 second timeout is used.
Product Change	<b>PRODCHANGE</b>	<b>EXEC</b>	Numeric Inspection ID	Timeout (msec) or <b>NOWAIT</b>	By default, a 30 second timeout is used.
Counter or Flag Reset	<b>RESET</b>	<b>EXEC</b>	<b>SYSERRFLG</b> or <b>PASSFAILCNT</b> or	None	Reset either the System Error Flag, Pass and Fail counters, or Missing Trigger count.

System Object, Component, or Activity	Object or Activity Identifier	Support Actions	Required Qualifiers	Optional Qualifiers	Comments
			MISSTRIGCNT		
Remote Teach	<b>RTEACH</b>	<b>EXEC</b>	None	<b>TRIGGER</b> or <b>TRIGGER NOWAIT</b> or <b>TRIGGER</b> Timeout (msec)	Enables remote teach. If no qualifiers are specified, remote teach will occur on the next trigger. If <b>TRIGGER</b> qualifier is specified, remote teach will occur immediately, and the command will block until a default 30-second timeout expires. If <b>TRIGGER NOWAIT</b> is specified, remote teach will occur immediately, and the command will return right away. If a timeout value is specified, the command will block until the specified timeout expires.
Online Status	<b>ONLINESTS</b>	<b>GET</b>	None	None	Retrieve the sensor online status.
Ready State	<b>READYFLG</b>	<b>GET</b>	None	None	Returns 1 if the camera is

<b>System Object, Component, or Activity</b>	<b>Object or Activity Identifier</b>	<b>Support Actions</b>	<b>Required Qualifiers</b>	<b>Optional Qualifiers</b>	<b>Comments</b>
					ready, 0 otherwise
Current Inspection Number	<b>INSPNUM</b>	<b>GET</b>	None	None	Retrieve currently running inspection
Communications Tool Results	<b>COMMTOOL</b>	<b>GET</b>	None	CommTool Number or CommTool Name	Retrieve comm tool results, either by specifying its sequential number in the inspection (1,2,...,n) or by specifying its name. By default, data for the first comm tool will be retrieved.
Pass/Fail flag	<b>PASSFAILFLG</b>	<b>GET</b>	None	None	Retrieve the value of the Pass/Fail flag - 1 if pass, 0 if fail
System Error	<b>SYSERRFLG</b>	<b>GET</b>	None	None	Retrieve the value of the System Error - either 0 or 1
Frame Number	<b>FRAMENUM</b>	<b>GET</b>	None	None	Retrieve the current frame number
Pass Count	<b>PASSCNT</b>	<b>GET</b>	None	None	Retrieve the pass count
Fail Count	<b>FAILCNT</b>	<b>GET</b>	None	None	Retrieve the failed count
Iteration Count	<b>ITERCNT</b>	<b>GET</b>	None	None	Retrieve the Iteration Count

<b>System Object, Component, or Activity</b>	<b>Object or Activity Identifier</b>	<b>Support Actions</b>	<b>Required Qualifiers</b>	<b>Optional Qualifiers</b>	<b>Comments</b>
System Error Count	<b>SYSEERRCNT</b>	<b>GET</b>	None	None	Retrieve the system error count
Missed Trigger Count	<b>MISSTRIGCNT</b>	<b>GET</b>	None	None	Retrieve the missed trigger count
I/O Line Status	<b>IOSTS</b>	<b>GET</b>	I/O line id, numeric, either <b>1</b> through <b>4</b> or <b>1</b> through <b>6</b>	None	Retrieve the cached status of the I/O line
Gain	<b>GAIN</b>	<b>GET</b>		None	Retrieve the gain
Gain	<b>GAIN</b>	<b>SET</b>	Positive Integer	None	Set the gain
Exposure	<b>EXPOSURE</b>	<b>GET</b>		None	Retrieve the camera exposure
Exposure	<b>EXPOSURE</b>	<b>SET</b>	Positive Number	None	Get the camera exposure
Frame Number Tag	<b>FRAMETAG</b>	<b>SET</b>	<b>ENABLE</b>	None	Enables frame number as command acceptance indicator
Frame Number Tag	<b>FRAMETAG</b>	<b>SET</b>	<b>DISABLE</b>	None	Disables frame number as command acceptance indicator
Frame Number Tag	<b>FRAMETAG</b>	<b>GET</b>	None	None	Retrieve the status of the frame tag indicator

## 8.7.2 RCC Return Values

RCC return values are numeric, and are listed below:

- 0 - command accepted. This return code is generated when a valid SET, GET, and EXEC command has been completely handled by the sensor. It may be followed by a command-specific return value or a completion code.

If the frame tag is enabled, the current frame number will be returned instead of 0 as command acceptance indicator.

- -100 - Invalid command entered by the user.
- Trigger and Product Change error codes:
  - -201 - Product change command attempted in the middle of the inspection
  - -202 – Trigger command attempted in the middle of product change
  - -203 – Trigger command is attempted when the inspection is not executing (sensor is idle)
  - -204 – Specified inspection slot is out of range
  - -205 – Trigger command attempted in the middle of the inspection
  - -206 – Product change command attempted in the middle of a product change
  - -207 – Product change command attempted while the sensor is in the Teach mode
  - -208 – Product change attempted when the GUI is connected, and the inspection is not executing
- Comm tool error codes
  - -301 – get/set tool command attempted while the inspection is not executing
  - -302 – get command issued before inspection is triggered for the first time – tool results unavailable
  - -303 – get/set tool command attempted in the middle of the inspection
  - -304 – get/set tool command attempted in the middle of the product change
  - -305 – Tool specified in get/set command not found in the inspection
  - -306 – Requested comm tool is not configured for RCC
  - -307 - Tool executed with an error or did not execute
  - -308 - Specified tool operand is not a constant, and cannot be modified
- Reset command error codes
  - -401 – Reset command attempted in the middle of the inspection
  - -402 – Reset command attempted in the middle of the product change
- -500 – RCC commands are not accepted because the sensor is in the Playback mode
- Timeout error codes
  - -600 – Product change timeout occurred
  - -601 – Trigger timeout occurred
- -700 – Specified value is out of range
- -701 – Set Gain command attempted when the GUI is connected and the inspection is not executing
- -702 – Set Exposure command attempted when the GUI is connected and the inspection is not executing
- -800 – Product Change, Trigger or Get Commtool command attempted when either Product Change or Trigger Command timeout occurred, but the operation has not yet completed.

### 8.7.3 Frame Tag Numbers

RCC provides user with a debug facility that allows users to correlate command completion with current frame numbers. This facility is enabled by issuing a SET FRAMETAG ENABLE command. This command will cause

RCC to send the current frame number as the command acceptance code. This will allow users to track when each command was issued, and which frame it applies to.

For EXEC TRIGGER command, returned number will be the frame number at the completion of the inspection execution.

For EXEC TRIGGER command, returned number will be the frame number at the completion of the inspection execution.

For all other commands, the returned number is the current frame number.

## 8.7.4 Command Processing

RCC commands are interpreted in the context of the running PPVS system. Due to the constantly changing system state caused either by external action or by previous RCC commands, certain rules are imposed on RCC command acceptance and processing. Please note that command acceptance does not constitute successful completion of the command.

1. EXEC TRIGGER command can be successfully accepted under the following conditions:
  - Inspection is Executing and is Ready
2. EXEC PRODCHANGE command can be successfully accepted under the following conditions:
  - Sensor is idle (inspection is not loaded), and the GUI is not connected
  - Inspection is Executing and is Ready
  - Sensor was previously product changed to an invalid slot
3. EXEC RESET command can be successfully accepted under the following conditions:
  - Sensor is idle (inspection is not loaded)
  - Inspection is Executing and is Ready
4. SET GAIN or SET EXPOSURE commands can be successfully accepted under the following conditions:
  - Inspection is Executing and is Ready
5. GET status, counter or flag commands can be accepted at any time. If issued when inspection is Executing but is not Ready, these values may change as the inspection is executing.
6. GET COMMTOOL command can be successfully accepted if the inspection has been loaded. However, RCC may not have valid data until the inspection has been triggered (executed) at least once.

Commands with timeouts, such as EXEC TRIGGER and EXEC PRODCHANGE, will block processing of additional commands while they are executing if they are invoked without the NOWAIT option. Additional commands that are issued while processing is blocked will be queued, and will be processed in the order that they were received when the blocking command finishes its execution.

When blocking commands, such as EXEC TRIGGER and EXEC PRODCHANGE, are invoked with the NOWAIT option, GET commands that retrieve flags and status are accepted for processing. All other commands are rejected with an appropriate error code.

## 8.7.5 RCC Log

RCC Log allows users to monitor and troubleshoot communication inputs and outputs.

Log consists of a circular buffer with up to 400 entries. These entries can be one of three types:

- IN – characters received in the input stream
- CMD – commands that were extracted after the frame start and frame end delimiters have been received
- OUT – formatted command output, with frame delimiters already included.

Log entries are time stamped with system time and sorted in the order they were received.

Non-displayable ASCII characters are shown in the ASCII Hex string form. The ASCII Hex strings are preceded by character sequence “\x” (backslash-lower-case-x). The ASCII Hex string will always be two characters long. For example, NULL will be converted to “\x00”, and carriage return will be converted to “\x0D”. To represent ASCII Hex digits, only upper case letters, A-F, are used.

Sample RCC log is given below:

```
0000000118.116 IN e
0000000118.116 IN x
0000000118.116 IN e
0000000118.116 IN c
0000000118.116 IN
0000000118.116 IN t
0000000118.116 IN r
0000000118.116 IN i
0000000118.116 IN g
0000000118.116 IN g
0000000118.116 IN e
0000000118.116 IN r
0000000118.116 IN \x0D
0000000118.116 IN \x0A
0000000118.116 CMD exec trigger
0000000118.483 OUT 0\x0D\x0A
```

In this example, command exec trigger was sent to RCC interface. The interface was configured to use no start frame delimiter, and carriage return (\x0D) and line feed (\x0A) as frame delimiters. As soon as valid frame delimiters were received, the command exec trigger was sent for processing, and the command response was sent back after inspection finished executing.

## 8.7.6 Frame and Field Delimiters

The PresencePLUS GUI includes a drop-down list of Frame delimiters as follows:

- **<none>** for no delimiter
- \r for carriage return (<CR>)
- \n for line feed (LF)
- \r\n for carriage return followed by a line feed (CR-LF)
- \n\r for line feed followed by a carriage return (LF-CR)

In addition to the above field delimiters, you can enter other delimiter types keeping in mind the following:

- ASCII hex format can be used as a delimiter
- a NULL character can be used as a delimiter (specified in ASCII hex format)
- Frame delimiters can be multi-character sequences up to 20 characters long

The PresencePLUS GUI includes a drop-down list of Field delimiters as follows:

- **<none>** for no delimiter
- , for comma
- ; for semi-colon

- : for colon
- <SPC> for space
- \t for tab

In addition to the above field delimiters, you can enter other delimiter types keeping in mind the following:

- ASCII hex format can be used as a delimiter
- a NULL character can be used as a delimiter (specified in ASCII hex format)
- Field delimiters can be multi-character sequences up to 10 characters long

## Character Strings

Communications Tool configured for Barcode or String Tool output may produce strings that contain non-printable ASCII characters, such as carriage returns, line feeds, and characters in the upper ASCII range.

To output these strings, the following encoding rules are used:

- Tool output strings will be enclosed in double quote characters, “.”
- Any non-printable ASCII character, including NULL, will be converted to its ASCII Hex equivalent. The ASCII Hex string will be preceded by character sequence “\x” (backslash-lower-case-x). The ASCII Hex string will always be two characters long. For example, NULL will be converted to “\x00”, and carriage return will be converted to “\x0D”. To represent ASCII Hex digits, only upper case letters, A-F, will be used.
- Any backslash encountered in the Barcode or String Tool data will be converted to its ASCII Hex equivalent, “\x5C”.
- Any double quote encountered in the Barcode or String Tool will be converted to its ASCII Hex equivalent, “\x22”.

For RCC input strings, the formatting rules are expanded to accommodate readability as follows:

- Carriage return can be specified as character sequence “\r” (backslash-r).
- Line feed can be specified as character sequence “\n” (backslash-n).
- Double quote can be specified as character sequence “\” (backslash-doublequote).
- Backslash can be specified as character sequence “\\” (backslash-backslash).
- tab can be specified as character sequence “\t” (backslash-t).
- Embedded NULL characters are not allowed.



---

# Teach

The inspection parameters can be taught automatically by using the Teach function. There are two Teach options: Quick Teach and Teach. The Quick Teach button is in the Tools window, and the Teach button is in the Main Menu toolbar.

## 9.1 Quick Teach

Use Quick Teach to set the Pass/Fail parameters based on the reference image. This is a fast way to start inspecting products with minimal effort. This method works best when the reference image is a good representation of all the parts. If the good parts can vary in appearance, standard Teach is a better option.

Click the **Quick Teach** button to trigger the following events:

1. The results calculated from the reference image are transferred to the minimum and maximum fields in the Test tool.
2. If a tool's Results field includes a tolerance (e.g., shortest distance), then the additional tolerance is calculated (default is 10%).
3. The Save window prompts the user to save the inspection on the Sensor.
4. The software proceeds to the Run screen.

 **Caution:** Quick Teach will overwrite all the minimum and maximum values in the Test tool. If values were entered manually, or no changes are desired, go directly to Run without clicking Quick Teach.

## 9.2 Teach

Use **Teach** to automatically set the Pass/Fail parameters based on a sample of good parts. Instead of using the reference image as the good part, Teach uses new good parts that are presented to the sensor under running conditions.

 **Note:** The Teach screen looks very similar to the Run screen. Verify that the sensor is at the Run screen and not the Teach screen before running an inspection.

There is no limit to the sample size during the Teach process. Teach will only expand the parameter window. If the current tolerances were greater than the sample set shown during the Teach process, then the Sensor will retain the old tolerances. Use Teach when there is a large part variation between the good parts.

 **Caution:** Only use good parts with Teach. A taught bad part will pass the inspection.

## 9.3 Teach Screen

To display the Teach screen, click the Teach button on the Main Menu toolbar, or click the Next button on the Tools screen Build tab.

Use the Teach screen to automatically set judgment tolerances to accommodate all variations of good product. After teaching the inspection, typically proceed to the Run screen to run it.



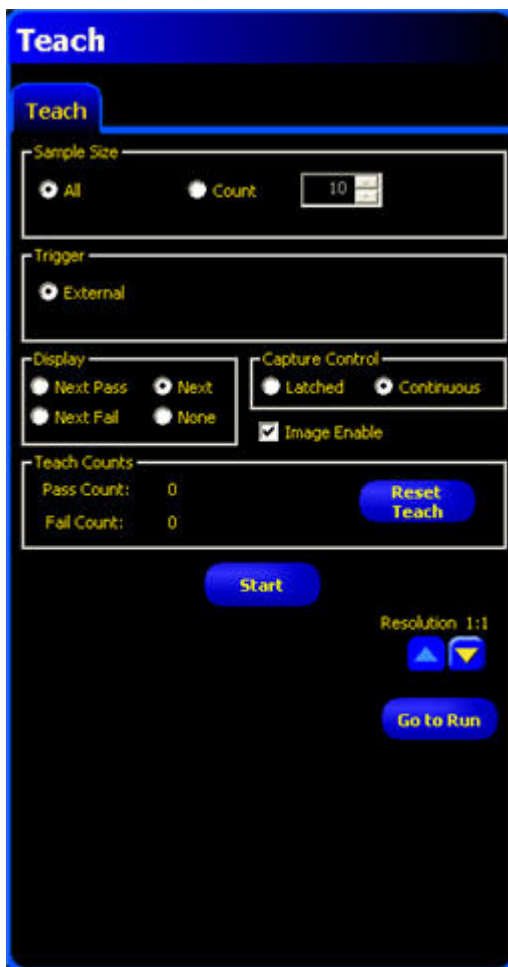



 **Note:** Before entering the Run screen, a pop-up prompts the user to save the inspection. Save the inspection to one of the memory locations on the Sensor. As an alternative to teaching, enter judgment tolerances in the Results tab in the Test tool, and run the inspection without teaching.



### 9.3.1 Teaching an Inspection

Teaching on a number of known good samples finds acceptable variations and automatically sets the judgment tolerances to accommodate the full range of acceptable results.

Several Teach parameters may be selected in the Teach tool's Teach tab, such as how many images to consider during a teaching session and what type of captured images to display.

Teach Screen Field/Button	Description
	<p>Use All to not limit the Teach sample size. All is the default.</p> <p>Use Count to have the Sensor automatically stop the Teach process after a set number of samples.</p> <p>Use the Count option when there is a known sample set size. Use the arrows to increase or decrease the sample size. When the sample size is reached, the Sensor will stop the Teach process, and the Start/Stop button will return to displaying Start.</p>
	<p>The Sensor must receive an external trigger (pin ) to accept a sample.</p>
	<p>Determines when information is updated on the PC.</p> <ul style="list-style-type: none"> <li>• <b>Next Pass:</b> Display the next passing inspection.</li> <li>• <b>Next Fail:</b> Display the next failed inspection.</li> <li>• <b>Next:</b> Display the next available inspection.</li> <li>• <b>None:</b> Do not display inspections.</li> </ul>
	<p>Capture Control determines how often information is updated on the PC.</p> <ul style="list-style-type: none"> <li>• <b>Latched:</b> Sets the Display option to None after an inspection is displayed to prevent displaying additional inspections.</li> <li>• <b>Continuous:</b> Continuously updates the inspection information according to the display option.</li> </ul> <p> <b>Note:</b> The display may not capture every inspection.</p> <ul style="list-style-type: none"> <li>• <b>Image Enable:</b> Determines if the image is included in the result information. If checked, the inspection image and results will update upon capture. If unchecked, only the results will update upon capture.</li> </ul> <p> <b>Note:</b> Displaying the image on the PC will add to the inspection time.</p>

Teach Screen Field/Button	Description
	<p>Teach Counts tracks the number of samples used in each Teach process. Teach ignores samples that fail. Samples fail for the following reasons:</p> <ul style="list-style-type: none"> <li>• An Edge tool before the Test tool fails.</li> <li>• A Locate tool before the Test tool fails.</li> <li>• Measure tool fails to find two points.</li> <li>• Time-out error.</li> <li>• An ROI rotates or translates off the screen.</li> </ul> <p>Click the Reset Teach button to clear all previously gathered data.</p>
Start	Click the Start button to start the Teach routine.
Stop	Click the Start button to stop the Teach routine.
Next	When you click the Next button, the software prompts you to save the inspection, and then it continues on to the Run screen.

## 9.4 Remote Teach

This section explains teaching inspections on good product using Remote Teach.

### 9.4.1 Understanding Remote Teach

The Remote Teach function is a method of remotely updating inspection parameters in Run mode. Vision tool(s) and Test tool(s) can each be selected to be taught. To remotely teach an inspection, the Remote Teach function must be enabled on each tool to be taught.

 **Note:** The Location tools, the Measure tool, and the Communication tool are not affected by Remote Teach.

The sequence of events in the sensor is as follows:

1. With the sensor in Run mode (and Ready), pulse the Remote Teach line (Pin 2, gray wire).
2. The sensor recognizes that the Remote Teach line is active and waits for the next valid trigger.
3. At the next valid trigger, Ready goes inactive (the Green Ready LED shuts OFF), and the sensor acquires a new image.
4. The sensor adjusts the ROI (if the inspection uses Location tools).
5. The Vision tool learns the new pattern and performs the analysis.
6. The sensor adjusts the minimums and maximums in the Test tool (if the Test tool is enabled for Remote Teach).

7. The inspection indicates Pass if the pattern meets the requirements of the Vision tool and (if the Test tool is enabled for Remote Teach) if the evaluation of the Test tool(s) passes with the adjusted minimums and maximums.
8. The inspection will Fail if the Vision tool(s) or the Test tool(s) fails. If the inspection fails, another Remote Teach sequence or user intervention is required.

### 9.4.2 Remotely Teaching a Tool

To remotely teach a tool, the user must enable Remote Teach on each tool to be taught. This can be accomplished by clicking on the Enable Remote Teach box in the tool window before running an inspection (typically performed when the inspection is created).

To perform a Remote Teach, do the following:

1. Verify that the correct tools are enabled for Remote Teach.
2. Verify that the sensor is in Run mode.
3. Verify that the Green Ready LED is ON.
4. Activate the Remote Teach input.
5. Position the target as desired.
6. Trigger the Sensor.

Following a Remote Teach, subsequent inspections will be performed with the newly learned parameters of the Vision tool(s) and the Test tool.



**Caution:** A successful Remote Teach will occur ONLY if the new target is similar in contrast to the original target. The exposure time and gain are NOT modified during Remote Teach.

### 9.4.3 Timing Sequence

The timing for the Remote Teach sequence is shown below (the diagram assumes Remote Teach is enabled on the tools and that all signals meet minimum times).

It is important to note that the remotely taught parameters are not saved to non-volatile memory; hence, the remotely taught inspection is good only as long as Run mode is maintained and power to the Sensor is not lost.

To record the remotely taught inspection, the logging function must be used.

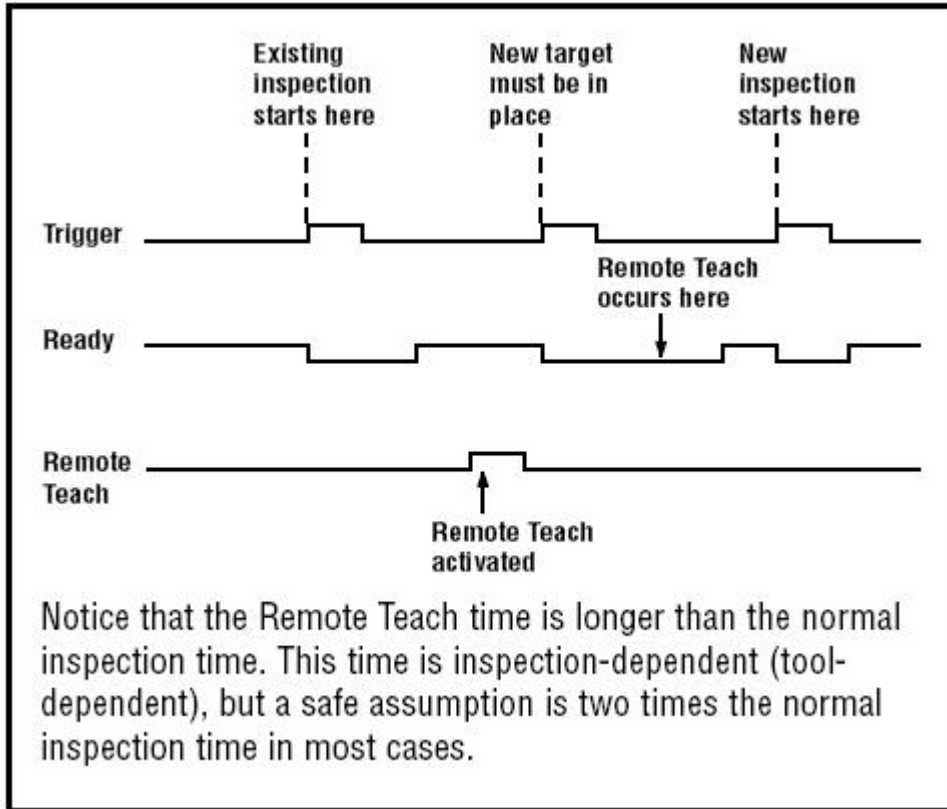

#### 9.4.4 Remote Teach Results

Remote Teach will indicate normal Pass/Fail results. To clarify normal results, the rules are as follows:

- If Location tools were used in the inspection, then they must perform correctly; that is, the Locate tool must find an edge, and the Vision tool(s) must find a pattern. If they do not perform correctly, the Remote Teach will fail, and the inspection will indicate Fail.

**Note:** If the Remote Teach fails for this reason, then the new pattern will not be taught, and the previous inspection will still be valid.

- If Location tools were used and they performed correctly or if Location tools were not used, then the Remote Teach will attempt to update the Vision tool (if enabled). If the Vision tool fails, then the Remote Teach will fail, and the inspection will indicate Fail.

**Note:** If the Remote Teach fails for this reason, then the existing inspection is not valid. The Remote Teach inspection will continue to fail until a new inspection is taught or selected (via Product Change) or until the Sensor is taken out of Run mode.

- If the Remote Teach is successful, the inspection will indicate Pass, and the new inspection will perform with the new parameters.

---

# Run Screen

Use the Run screen to start, stop, monitor, and log an inspection. To display the Monitor tab on the Run screen, click Run in the Main Menu toolbar. The Monitor tab is the default tab in the window.

To exit the Run screen, verify that Run is stopped, and click another destination on the Main Menu toolbar.

While running an inspection, you can monitor the following:

- Pass and Fail counts
- The status of inputs, outputs, Product Select System errors, and whether the Sensor is Ready
- Next Pass, Next Fail, Next Remote Teach, Next Remote Teach Fail, Next, None

To run an inspection, set options and preferences, and click the Start button.

Fields in the Monitor tab are explained below.

<b>Run Screen Monitor Tab</b>
-------------------------------



## 10.1 Selected Inspection

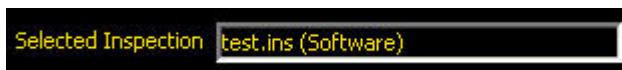

Displays the filename of the selected inspection. The default is the last saved inspection.

## 10.2 Display





Display Option	Description
Next Pass	Display next passed inspection.
Next Fail	Display next failed inspection.
Next RT	Display next remotely taught inspection.
Next FT Fail	Display next failed, remotely taught inspection.
Next	Display all inspections. The display is updated continuously, but because of transfer speed limits, not every image will be displayed. For faster image speed, reduce the resolution.
None	Display is not updated.

## 10.3 Capture Control



Capture Control Option	Description
Latched	The condition set in the Display field is displayed, or latched, until set.
Continuous	The condition set in the Display field is displayed.
Image Enable	<p>Checked: The PC displays an image of the inspection.</p> <p>Unchecked: The PC will collect the inspection information without an image.</p> <p> <b>Note:</b> Capturing images slows sensor response. For highspeed applications where the PC remains connected to the sensor, you should uncheck Image Enable unless absolutely necessary.</p>

## 10.4 Results

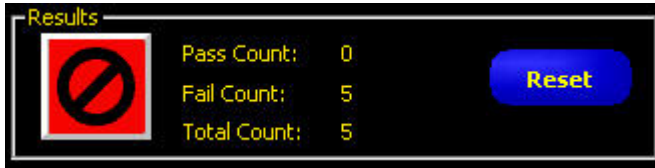

Results Field	Description
Pass Count	Number of passed inspections.
Fail Count	Number of failed inspections.
Total Count	Total number of inspections.
Reset Button	Clears teh counts for the selected inspection.

 **Note:** Each of the stored inspections has its own Pass/Fail registers to store the Pass/Fail counts for that particular inspection.

## 10.5 Inputs



Each numbered circle represents an input and its current state.

The legend below applies to the colored circles in the Inputs:

- Gray = Inactive (not currently available)
- Red = Active (not currently available)
- Not Visible = Not selected as input/output

## 10.6 Outputs



Each numbered circle represents an output and its current state.

The legend below applies to the colored circles in the outputs:

- Gray = Inactive (not currently available)

- Red = Active (not currently available)
- Not Visible = Not selected as input/output

## 10.7 Product Select



Displays the last latched Product Select (binary encoded).

The legend below applies to the colored circles in the outputs:

- Gray = Inactive (not currently available)
- Red = Active (not currently available)
- Not Visible = Not selected as input/output

## 10.8 System



E = System error

R = Ready

 **Note:** The results of the discrete I/O are not displayed in real time. They update approximately 4 times per second.

## 10.9 Start/Stop

Click the Start button to start running the inspection and click Stop to stop running the inspection.

## 10.10 Select Tab

The fields on the Select tab of the Run screen are described below.

**Product Select**

- The **Hardware Input** option signals the sensor to run the product option currently selected by the Product and Product Select input lines (not necessarily what is shown in the drop-down list on the tab). With this option selected, then, the Product Change and Product Select input will change the inspection when signaled to do so.
- The **Software Override** option is typically used for troubleshooting a specific inspection and it signals the sensor that you will manually select an inspection to run. The inspection displayed in the field next to **Software Override** will be the inspection that runs.

**Failed Image Hold**

Enter the number of seconds failed images should be displayed on the optional NTSC video monitor. The default is 1 second.

**Trigger Delay Adjust**

Enter the number of milliseconds to delay the camera before it takes a picture after the sensor receives a valid trigger. The default is 0 milliseconds.

- 👉 **Note:** Using the Trigger Delay when a part is triggered too early may be easier than moving the sensor.

Select Tab

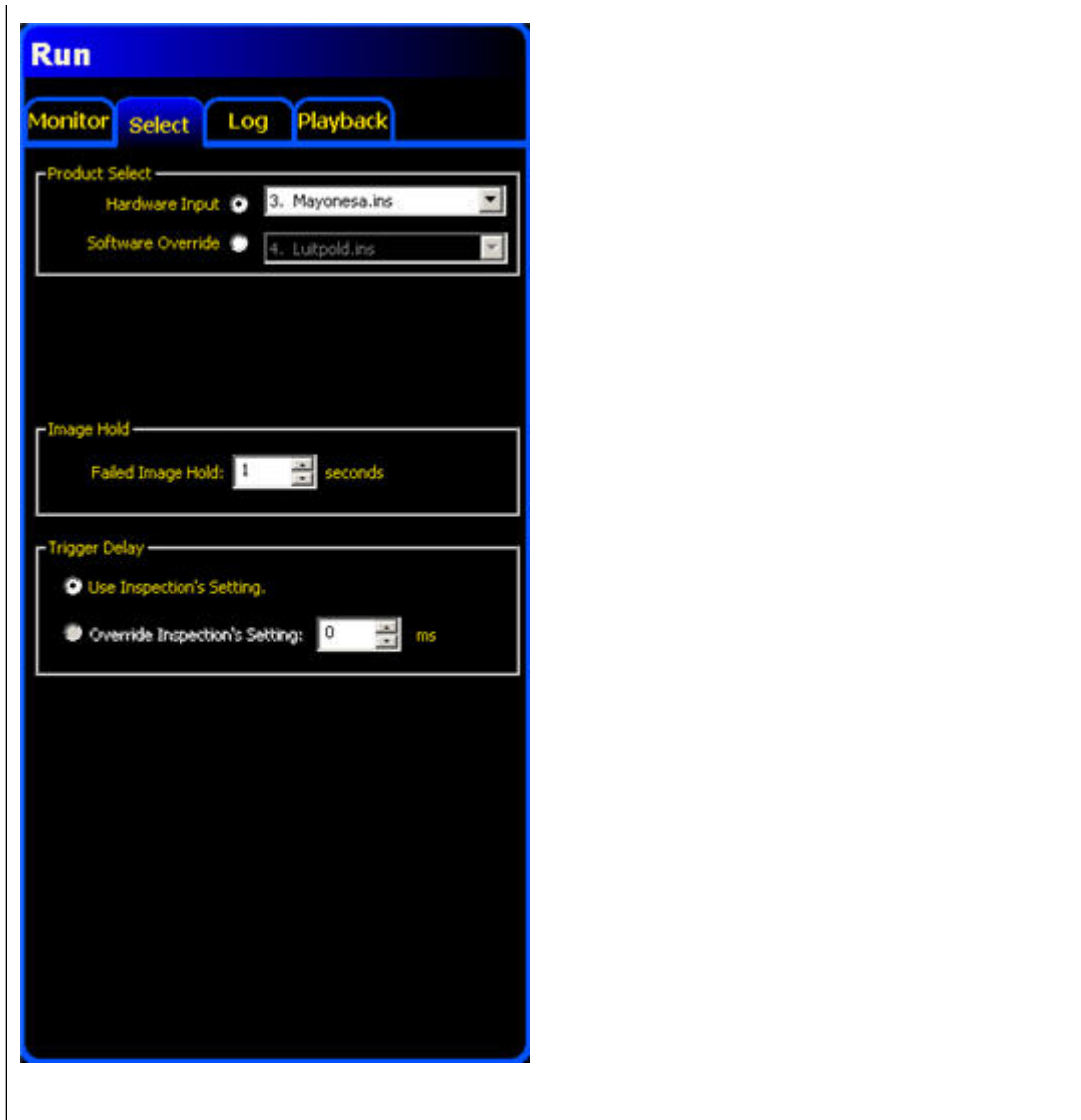

## 10.11 Log Tab

Fields in the Runs screen's Log tab are described below.

### Mode

- **Pass**-Logs only passed inspections based on Strategy.
- **Fail**-Logs only failed inspections based on Strategy.
- **RT**-Log remotely-taught inspections based on Strategy.
- **RT Fail**-Log failed, remotely-taught inspections based on Strategy.
- **Any**-Logs both passed and failed inspections based on Strategy.
- **None**-Log not updated.

**Strategy**

- **Last Ten**-Stores the previous 10 inspections that meet the Mode criteria (this is the default).
- **First Ten**-Stores the first 10 inspections that meet the Mode criteria.
- **First and Last Five**-Stores the first 5 and last 5 inspections that meet the Mode criteria.

**Camera**

Shows the number of stored inspections currently in the camera's memory.

- **Obtain** button-Moves the stored inspection data from the camera's memory to the GUI's memory.
- **Flush** button-Deletes all stored inspections from the camera's memory.

**PC**

- **Save All** button-Enables the user to write the log files from...
- **Save Selected** button-Enables the user to write the current log file from the GUI's memory onto a hard drive or other storage device.
- **Load** button-Enables the user to load a saved file from the computer's hard drive or other storage device into the GUI to be viewed.

**Result View**

- **Clear All** button-Deletes all inspections from the GUI's memory.
- **Clear Selected** button-Deletes the currently selected inspection from the GUI's memory.

**Log Tab**

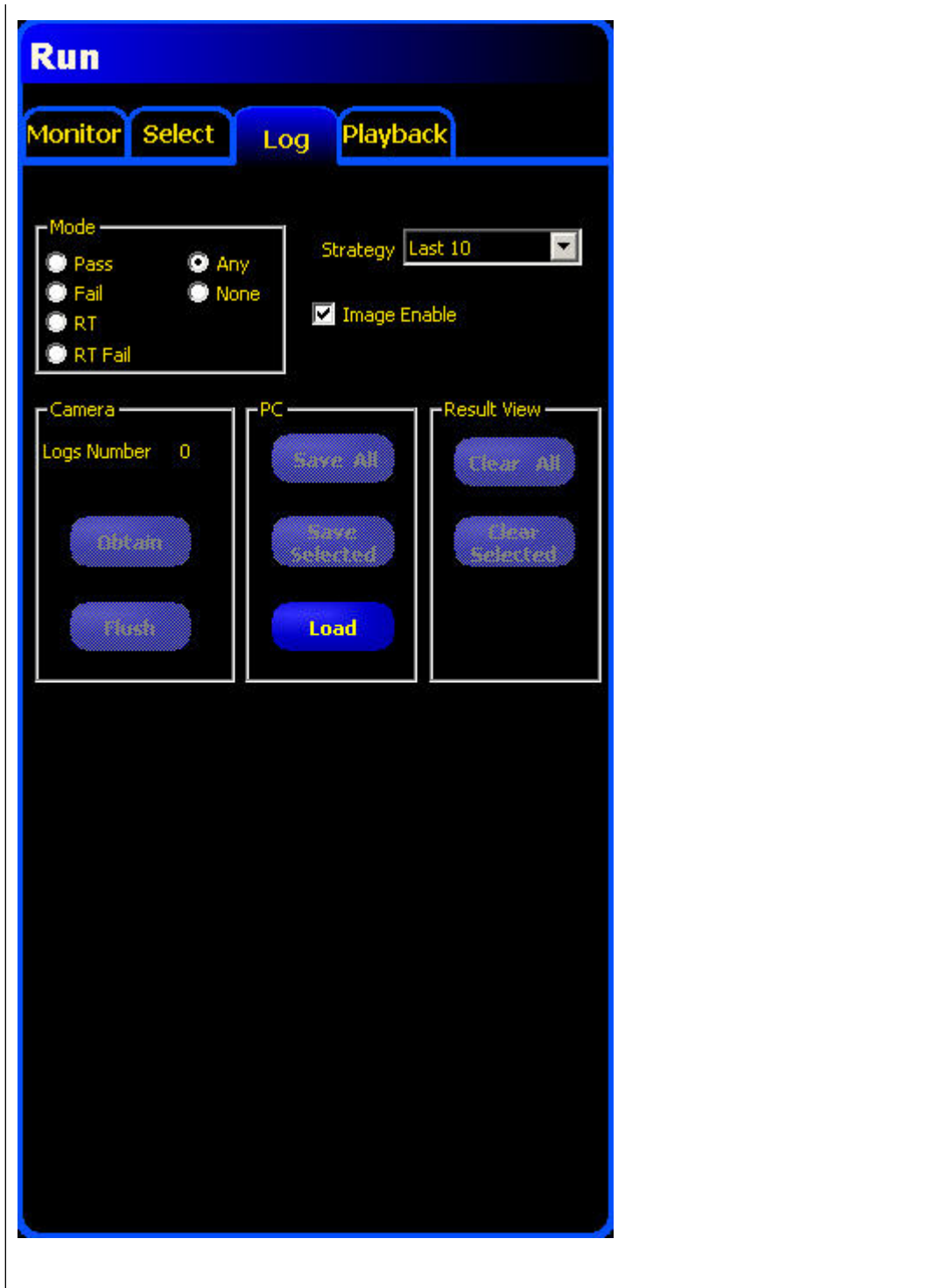

## 10.12 Run Results

In the Run screen, the Results/Navigation window at the bottom of the display defaults to the Results window shown below. The Results window provides information about the

last displayed inspection. Each tool in the list can be expanded to show its results. Each result shown indicates the tolerance assigned to the parameter and its current value.

- If the current value falls within the Test tool's set tolerance or if the tool executed properly, then a green checkmark symbol is shown beside that parameter.
- If the current value falls outside the Test tool's set tolerance or if the tool failed to execute properly, then a red failed symbol is shown beside that parameter.

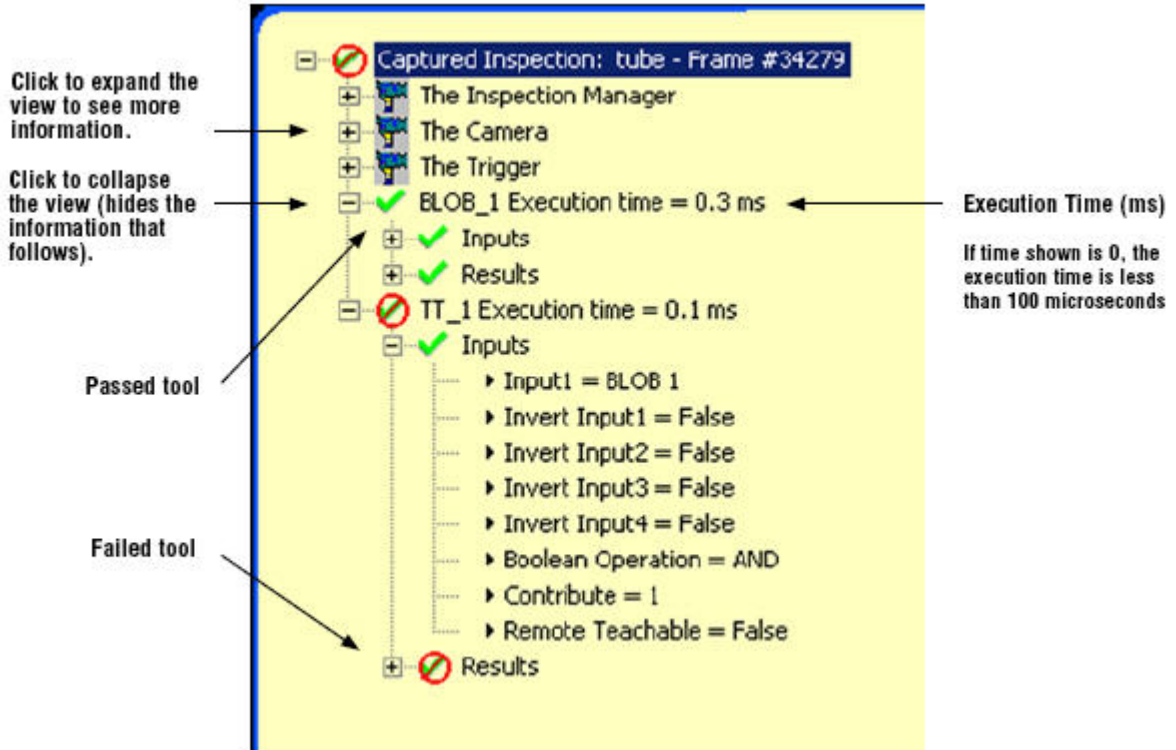

Name	Level	Parent Level	Description
Current Inspection	First	None	Name of currently running inspection.
The Camera	Second	Inspection Name	Sensor Information: • Gain • Exposure time (ms)
The Trigger	Second	Inspection Name	Trigger Input Information: • Divide • Delay • Width • Polarity
The Inspection Manager	Second	Inspection Name	General Inspection Information: • Fail hold time (ms): how long a failed image is displayed on the monitor



Name	Level	Parent Level	Description
			<ul style="list-style-type: none"> <li>• Power-up time: time since last shutdown (resolution = second)</li> <li>• Pass count</li> <li>• Fail count</li> <li>• Missed trigger count: total number of triggers missed because sensor was not Ready</li> <li>• Lifetime: ow long the sensor has been turned on (resolution = 1 hour)</li> <li>• Total inspection time minimum (ms): minimum inspection time recorded (resolution = 0.1 ms)</li> <li>• Total inspection time maximum (ms): maximum inspection time recorded (resolution = 0.1 ms)</li> <li>• Total inspection time (ms)*: inspection time from trigger until the end of processing time for last inspection (resolution = 0.1 ms) (does not include inspection capture to PC*)</li> <li>• Config timestamp: when inspection was created</li> </ul> <p>* Capturing an image on teh PC adds to the inspection time. Set display settings to None to decrease the inspection time to a minimum.</p>
Tools (tool name)	Second	Inspection Name	Information about current tool: <ul style="list-style-type: none"> <li>• Execution time (resolution = 0.1 ms)</li> <li>• Inputs (parameters set for the current tool)</li> <li>• Results (results of the current tool)</li> </ul>
System log	First	None	Not used

## 10.13 Run Player/Recorder

The Player/Recorder is typically used for troubleshooting and is actually two features in one—a bitmap Player and a bitmap Recorder. The Recorder can save image files from the camera to an external hard drive for later use. The Player can force the Vision sensor to run on these stored bitmaps rather than “live” pictures taken from the imager chip.

The Player/Recorder feature has two states, based on the status of the Start button. If the Start button has not been pressed, then the sensor can run on saved images. Once the Start button is pressed, then the sensor is evaluating live images and can't run on saved images.

For non-color cameras, the images which are saved by the Recorder feature are 8-bit grayscale bitmaps with the same resolution as the vision sensor they came from. A P4 Geo would generate 128x100 resolution BMP files (13.5 kB in size) while a P4 Omni would make 640x480 BMPs (302 kB) and a P4 BCR 1.3 make 1280x1024 BMPs (1282 kB). The Player feature will work only for the correct resolution images; but it does not care where those images come from originally. Anything that can generate an 8-bit grayscale bitmap of the correct resolution can be a source for Player images: a digital camera, a photo-editing software package, an image from another sensor, etc.

### Playback Tab

**Run**

Monitor Select Log Playback

Record Path: C:\Program Files\Banner Engineering ...

Record Mode: All Images

Preview Image:

PresencePLUS  
BANNER

Playback List:



### 10.13.1 Record

The Record tab is present on the Run screen when the vision sensor is running on live images (that is, the Start button has been pressed).



There are three steps to recording bitmap images using this feature:

1. **Choose a Record Path.** At the top of the tab, at the end of the line labeled Record Path, click the button. This will open up the Record to... window allowing you to browse for the folder where you want the images to be saved.
2. **Choose a Record Mode.** Right beneath the Record Path selection is the Record Mode drop down menu. This is where the user selects the conditions (if any) for saving images. The choices are similar to those for the Logging feature.

3. **Press Record.** After choosing which images to save and where to save them, the last step is to press the red Record button found midway down the page. As the images are saved, the file names will appear in the Playback List window. Press the record button or the square Stop button to stop recording.

### 10.13.2 Playback

The Playback feature is available whenever the vision sensor is in Run mode but the Start button has not been pushed. To enter Playback mode on a currently running sensor, hit the Stop button. Clicking on the Playback tab will bring up the screen shown below left. This screen is almost exactly the same as the Record screen shown earlier: the only differences are the title of the tab and the fact that the Record button is inactive.

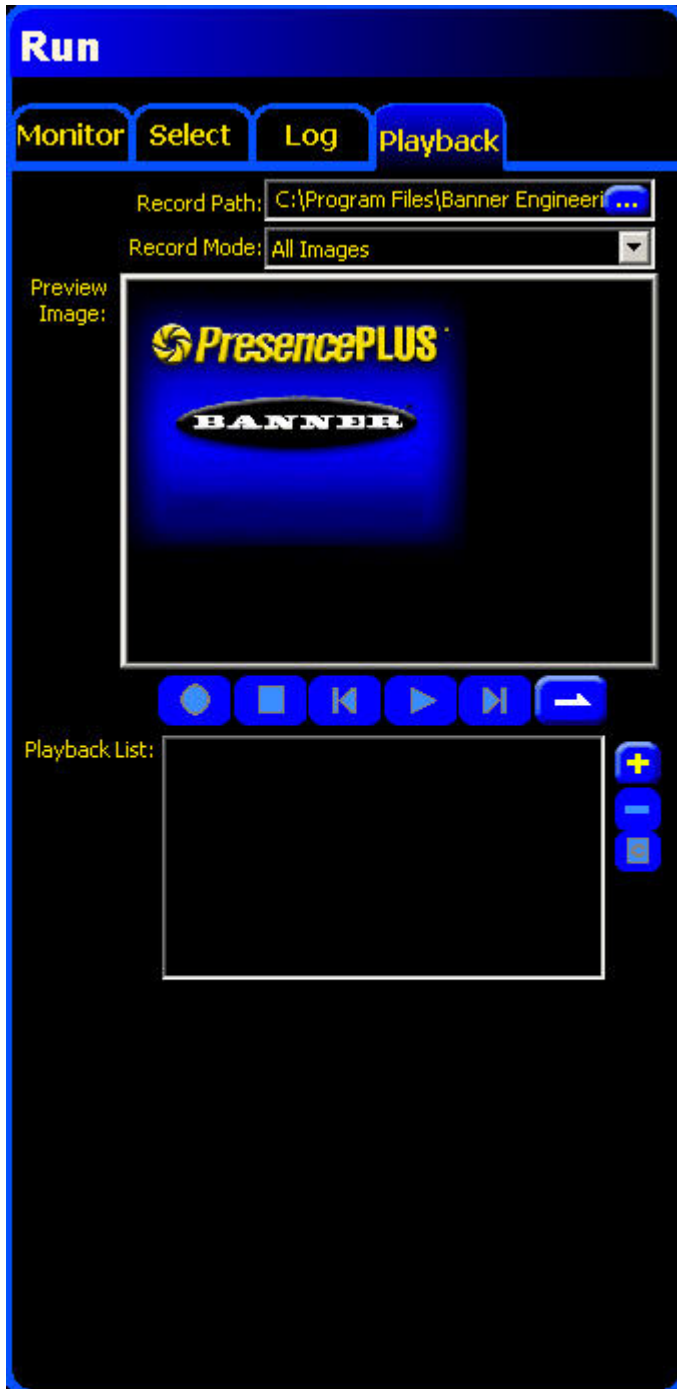

There are three steps to playing back bitmap images using this feature:

1. Load INP file. In Playback mode the vision sensor will be running off of stored images. These images will need to be evaluated in some way, using vision tools, etc. To begin the Playback process, load an INP file as if you are going to run the inspection on live images. When you get to the Run screen, however, hit Playback instead of Start.
2. Make a Playback List. At the bottom of the Playback screen is a box entitled Playback List. This is where you can see the collection of image files the Player will be feeding to the sensor. To add

a new BMP file to the Playback List, click the plus button . This will bring up the Add Image(s) window allowing you to find the relevant files on your computer.

3. Click the Play button. Once the Playback List is populated with image file(s), the Play button becomes active. When the Play button is clicked, the Play button becomes to the Pause button and the images in the Playback List are inspected. Press the square Stop button or the Pause button to stop.

### **Other Playback Features**

After files have been added to the Playback List, a couple of buttons become active:

- The minus button is used to remove the currently selected bitmap from the list.
- The Clear All Images button is used to erase all of the files on the list.

There are two Playback modes possible:

- Single Play Mode (the default). In this mode, the Player will run through all the files on the Playback List once and then stop.
- Repeated Play Mode is entered by clicking on the Single Play Mode button. Repeated Play puts the Player into a continuous loop inspecting the files on the Playback List over and over until the Stop or Pause buttons are clicked or the mode is changed back to Single Play.

Instead of running through all the files on the Playback List as fast as possible, the Player can be made to step through each image individually. Clicking on the file name in the list runs the inspection file once on that image. Using the Forward or Back buttons will allow you to step through the images one at a time.





---

# Product Change

This section explains the Product Change (pin 3) input.

The Product Change input is used in conjunction with one of the four I/O points programmed as Product Select lines. The inspection loaded will be executed following a valid trigger.

- The Product Change input responds to the leading edge transition of a pulse greater than 1 millisecond.
- The Product Select input is pulsed to correspond to a program location. For example, five pulses will load program #5.

## 11.1 Product Change Specifications

State	Current Sinking (NPN)	Current Sourcing (PNP)
ON	< 2V at 1 mA max.	> 8V at -7.5 mA max.
OFF	> 10 V at 4 mA max.	< 2V at -7.5 mA max.

One of the four I/O on the System Setup InputOutput tab must be programmed for Product Select if Product Change is to be used.

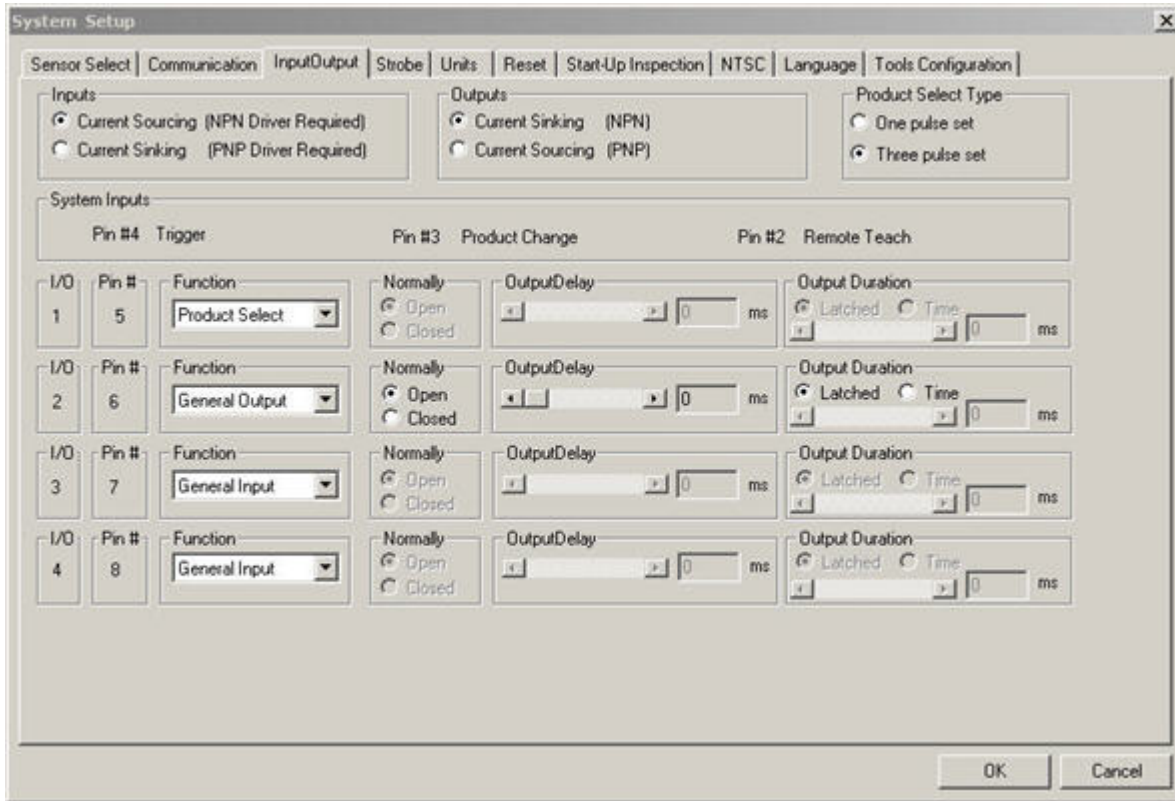

## 11.2 Product Select Input Specifications

State	Current Sinking (NPN)	Current Sourcing (PNP)
ON	< 2V at 1 mA max.	> 8V at -7.5 mA max.
OFF	> 10V at 4 mA max.	< 2V at -7.5 mA max.

---

# P4 Product Change and Product Select Timing

## 12.1 One Pulse Set Overview

The Product Change line signals the Sensor to stop what it is doing and begin counting pulses on the Product Select line. The number of pulses indicates to the Sensor the inspection address at which to begin executing the inspection. The only pulses counted are those that occur when the Product Change input is active. As shown in the diagram below, a Product Select input pulse that occurs when the Product Change input is not active is NOT counted.

If the Sensor is in Run mode, the Product Change line should be activated only when the Sensor Green Ready LED is ON. If the Product Change line is activated when the Sensor is in Run mode but performing an inspection (not Ready), the current inspection will be aborted, and the Sensor will proceed to load the inspection at the indicated address.

If the Product Change line is activated when the Sensor is not in Run mode (Setup mode, for example), then the Sensor will go to the address indicated (address number four in this case) and begin executing. The maximum number of pulses is limited by the number of inspections possible on the Sensor.

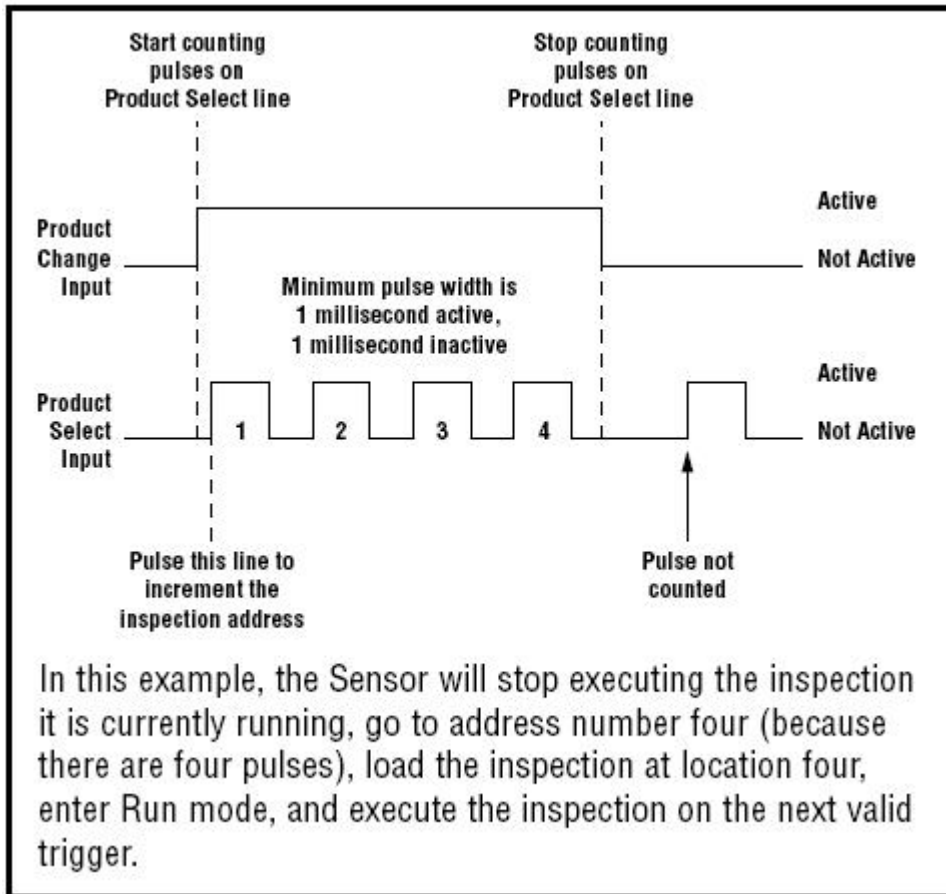

### 12.1.1 Product Select in One-Pulse Configuration

To use the product select option in the one-pulse configuration, follow these steps.

1. Select Hardware Input in the Select tab of the Run Screen.
2. Configure an I/O for Product Change in the System-Input/Output screen.
3. Set the Product Select Type to "One Pulse Set".
4. Assert the Product Change signal and then assert the number of pulse representing the inspection number to go to. To do this the Product Change signal must be asserted and held while the pulses representing the digit.

The selected inspection is displayed in the Product Select box in the Monitor under the Run screen.

 **Note:** Note: If the GUI is connected to the sensor there must be an inspection running to perform Product Change.

## 12.2 Three Pulse Set Overview

The Three Pulse Set uses the same I/O configuration as the standard One Pulse Set, but requires a different timing scheme. Instead of a single product change pulse, three product change pulses will be required, one for 100's digit of the program number, one for the 10's digit, and another for the 1's digit. Corresponding sets of pulses on the Product Select line are also required, as shown below:

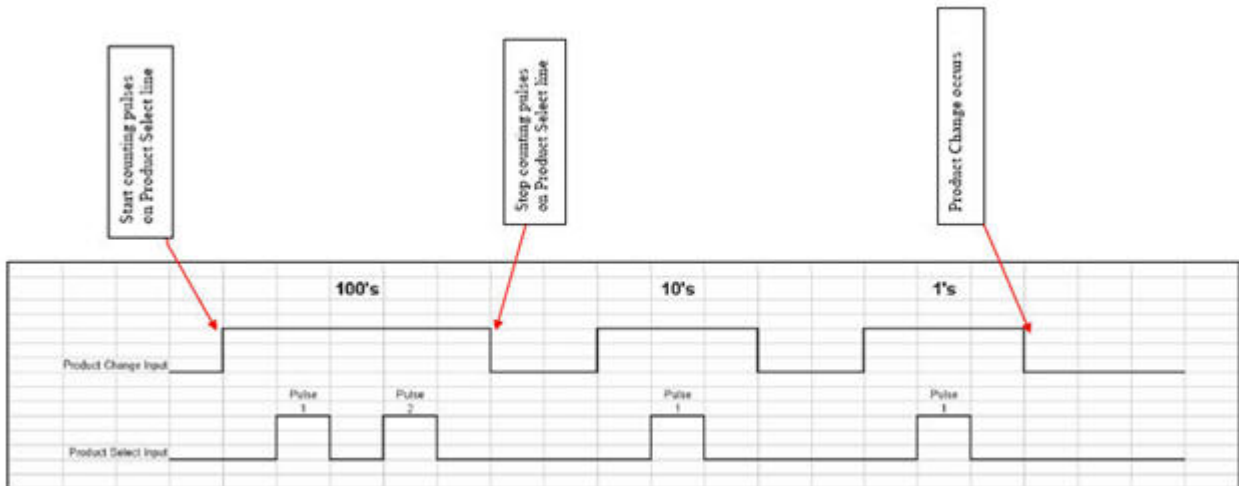

The timing diagram above shows the example for the product number 211. The minimum pulse width for all the timing is 1 ms to guarantee that the vision sensor will see the transitions. The valid number of pulses for each place is 0 – 9. If an invalid memory location is selected (or one which does not store a valid inspection file), the 'Current Inspection' number will be set to -1 and the sensor will be kicked out of Run mode. At this point, a Product Change to a correct inspection file will get the sensor back into Run mode and inspecting.

### 12.2.1 Product Select in Three-Pulse Configuration

To use the product select option in the 3-pulse configuration follow these steps.

1. Select Hardware Input in the Select tab of the Run Screen.
2. Configure an I/O for Product Change.
3. Select 3-Pulse set.
4. For the Input of Inspection to be selected, there are three sets of pulses and the pulses are setup in the following manner:
  - First set of pulses are for the 100's digit.
  - Second set of pulses are for the 10's digit.
  - Third set of pulses are for the 1's digit.

The user will need to assert the Product Change signal for each set of pulses. To do this, the Product Change signal must be asserted and held while the pulses representing the digit are being sent, and released after the last pulse is given. Valid range of pulses for all digits is 0 - 9.



---

## Saving Inspections

Inspection (.ins) files can be saved either to the sensor or to the PC. You need to save inspections to the sensor in order to run them; however, you can also save a copy to the PC or your network as a backup.

An inspection (.ins) file contains the image parameters, inspection parameters and, optionally, the reference image:

- Image parameters are the programmed values used by the sensor to acquire the inspection image. These values include gain, exposure time, and trigger setup.
- Inspection parameters include Location tools, Vision tools, and Analysis tools as well as their associated parameters.
- The reference image is the image selected in the Setup screen.

Use the Save window to save an inspection to the Sensor or to save to an Inspections folder on the PC or network.

To display the **Save** dialog, click the Save button in the Menu toolbar.

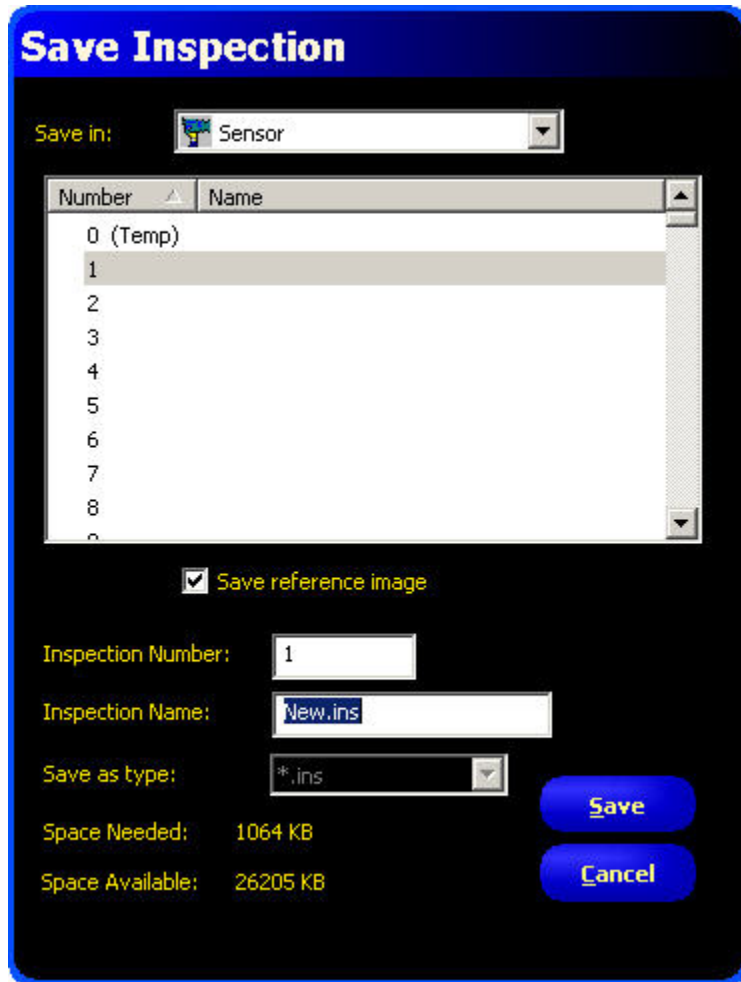

## 13.1 Saving Inspections to a Vision Sensor

To save an inspection to a Vision sensor:

1. Click on the Save button in the Menu toolbar to display the Save Inspection dialog.



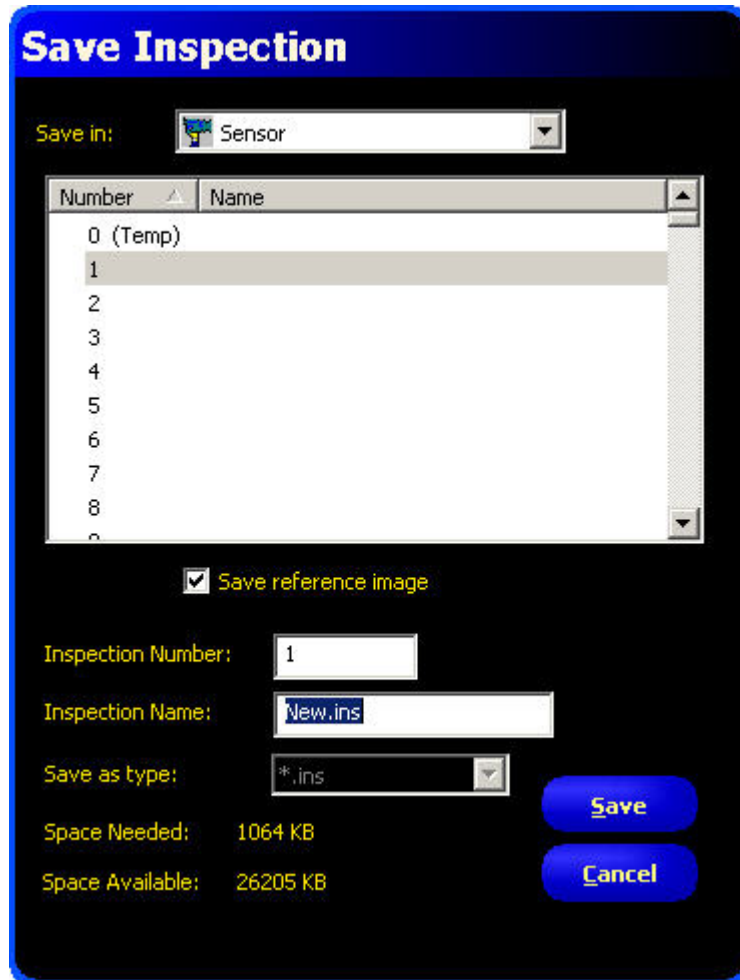

2. Use the scroll bar and select an Inspection Number by clicking in the dialog next to the number where you want to store the inspection, or enter a number in the **Inspection Number** field.
3. In the **Inspection Name** field, enter a name for the inspection.
4. Click the **Save** button in the dialog.

 **Note:** Check the **Space Needed** and **Space Available** fields to ensure there is room to save an inspection. You can choose whether to save a reference image. Not saving a reference image with the inspection frees up a lot of room onboard the sensor. However, inspections that include any of the following tools require a reference image to be saved:

- Geometric Find
- Geometric Count
- Pattern Find
- Pattern Count
- Color Match
- Color BLOB

## 13.2 Saving Inspections to a PC or Network Drive

To save an inspection to a PC or network drive:

1. Click on the Save button in the Menu toolbar to display the Save Inspection dialog.

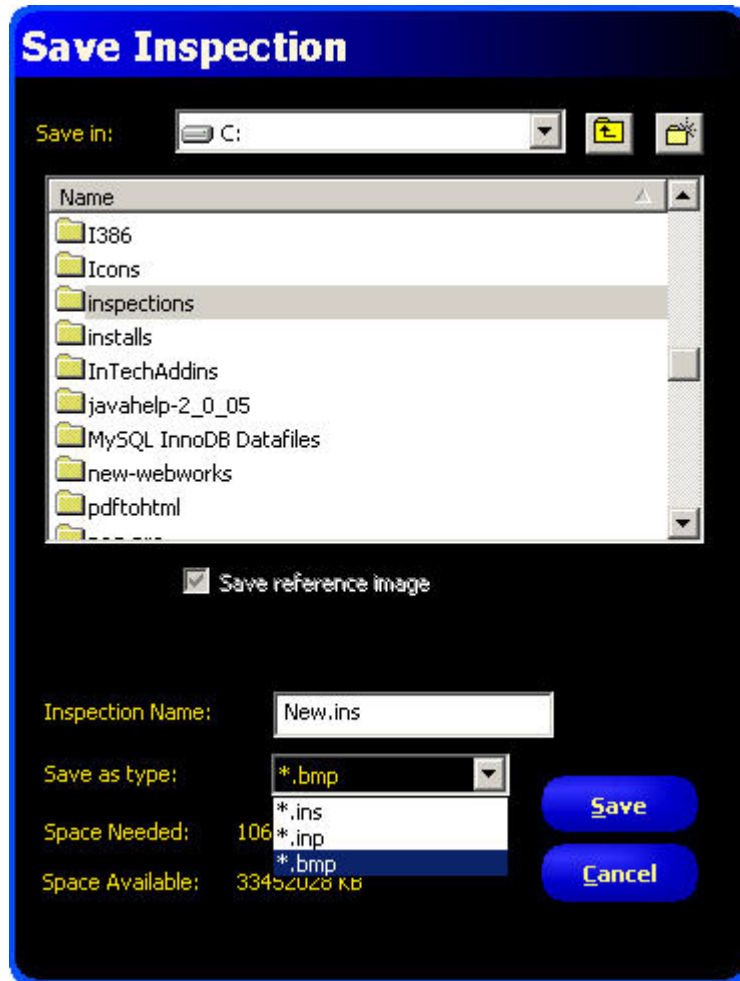

2. Select a disk drive from the **Save in** field.
3. Select a drive and a location for the stored inspection.
4. In the **Inspection Name** field, enter a name for the inspection.
5. From the Save as type drop-down, select:
  - \*.ins to save as a standard format for Vision sensors
  - \*.inp to save in an older format for compatibility with older sensors.
  - \*.bmp to only save the current image.
6. Click the **Save** button in the dialog.

# Backing Up and Restoring Vision Sensor Data

## 14.1 Backing up Vision Sensor Data

To back up Vision sensor data:

1. Insert the PresencePLUS installation CD into the CD-ROM drive, and launch the install program.
2. Click on **PresencePLUS Update Firmware**.



3. From the list of sensors in the **PresencePLUS Firmware Updater**, select the sensor you want to back up, and click **Connect**.

4. Click on the **Sensor Backup** tab.

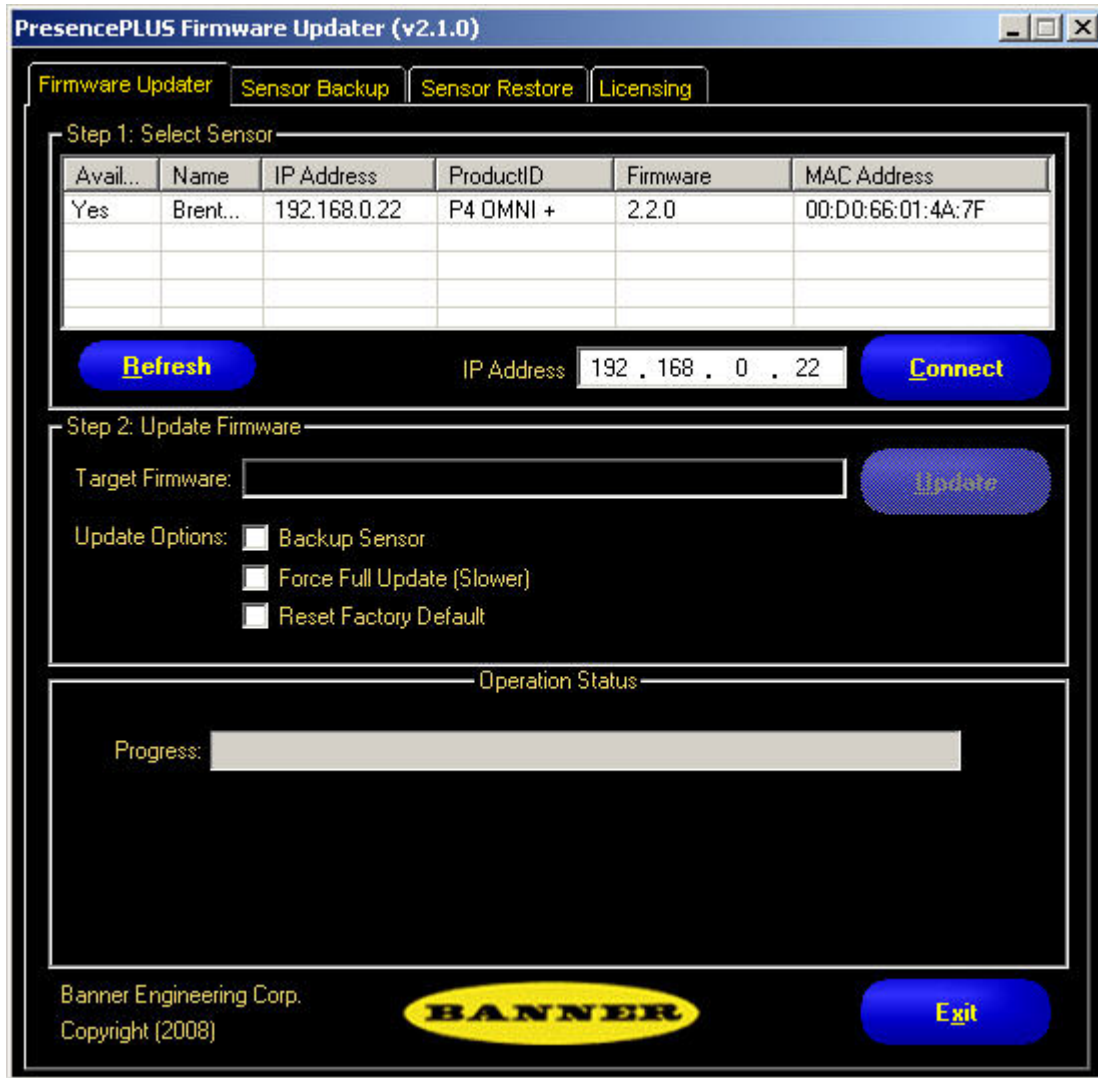

5. In the Create Backup section, click on the ellipses (...) button to select a filename for the backup file as well as a location for the backup on the local computer or on the network.

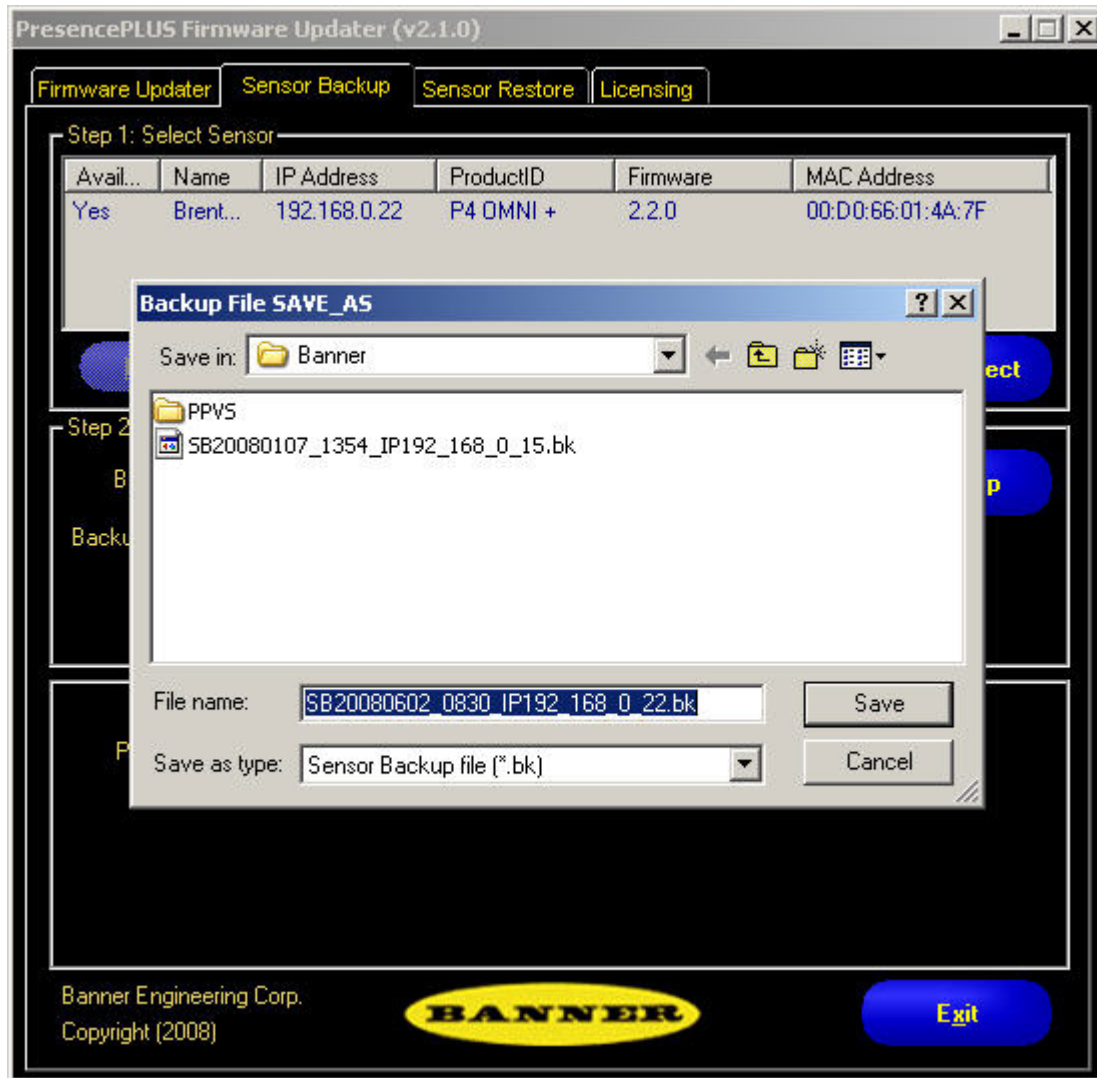

6. In the Backup Content field, select either of the following to backup:

- [ Firmware ] + [ Configuration ] + [ Inspection(s) ]
- [ Configuration ] + [ Inspection(s) ]

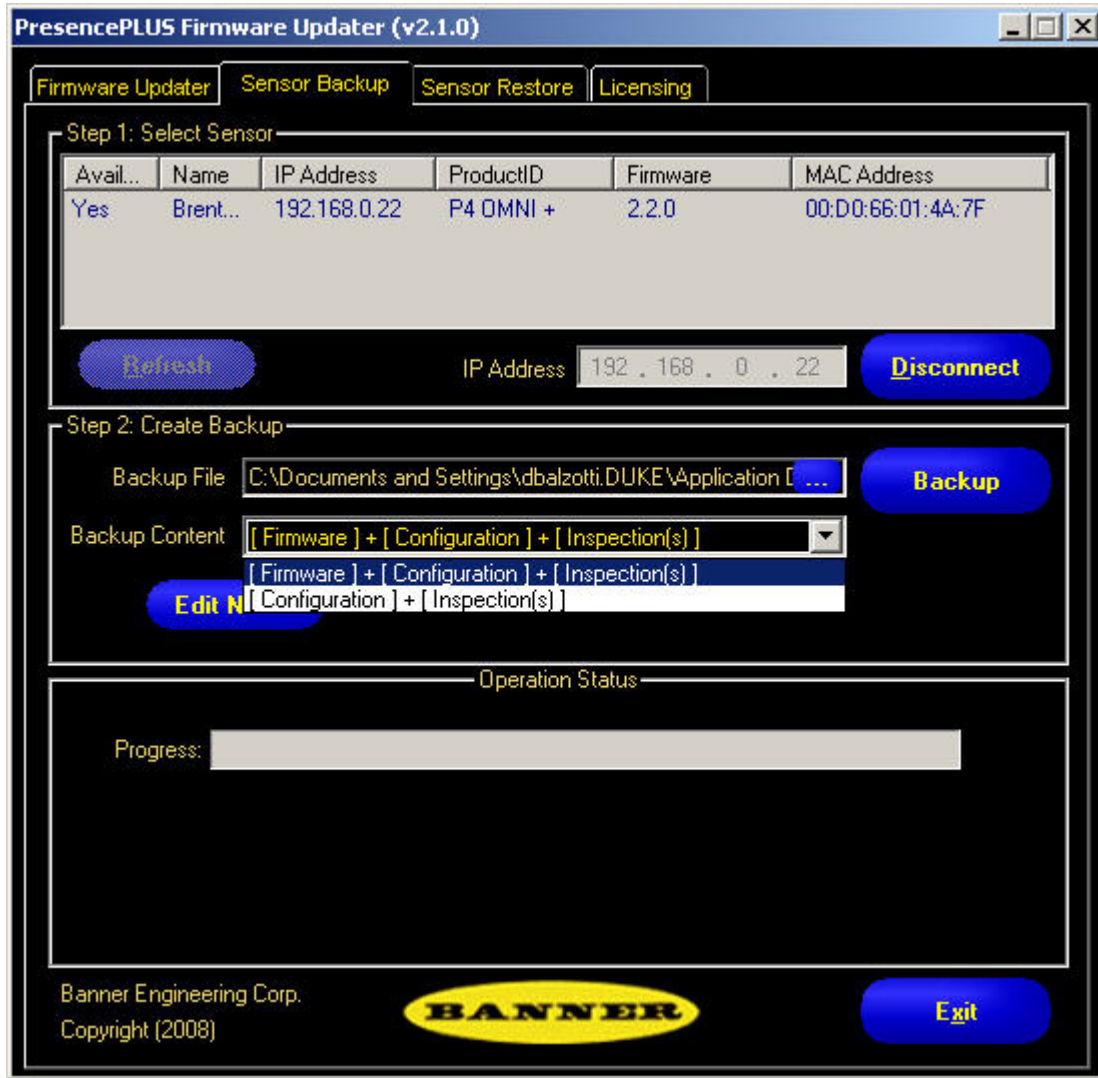

7. Optionally, click on the Edit Note button to add notes for the backup operation.

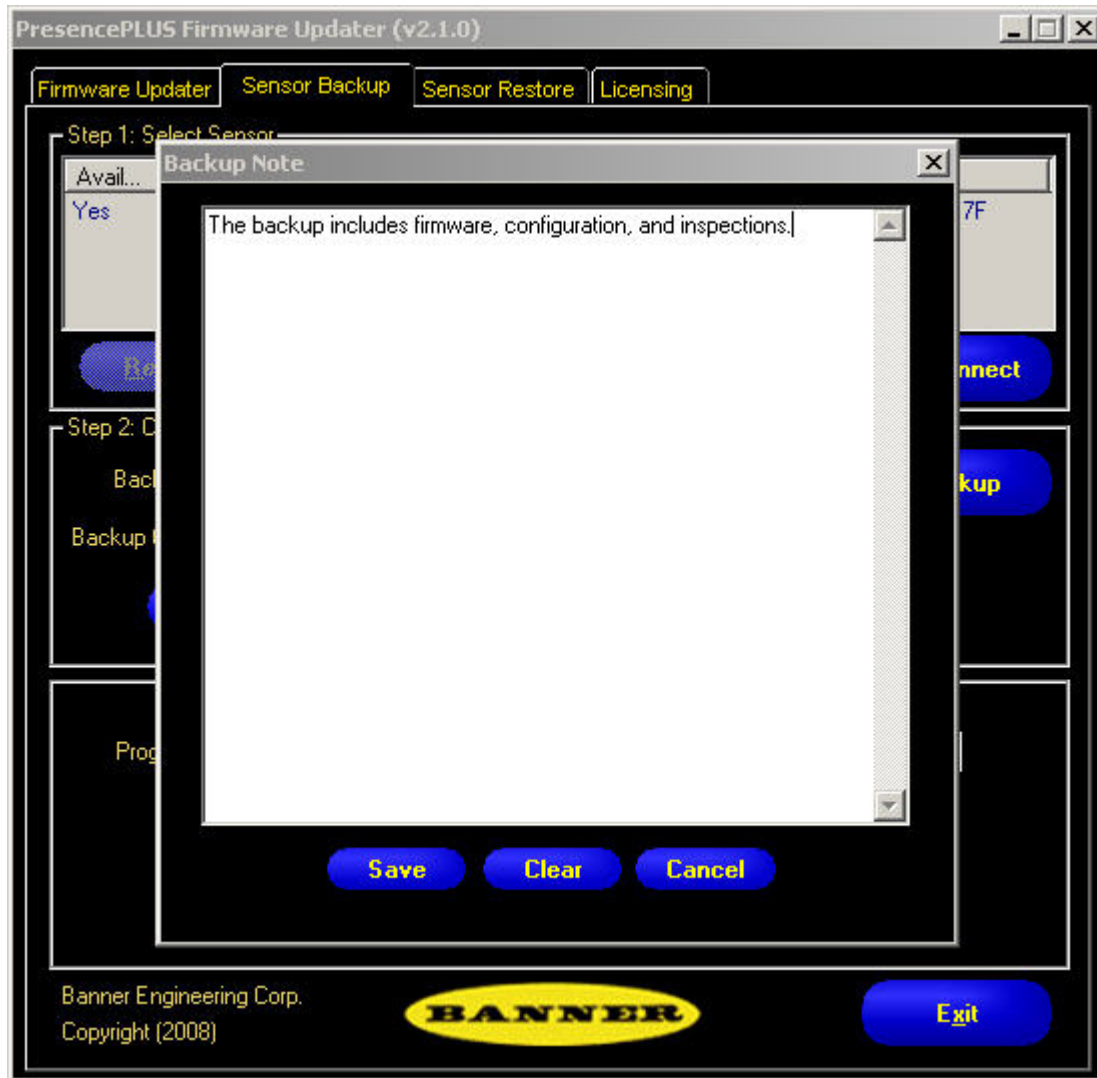

8. Click the **Backup** button to back up Vision sensor data.

## 14.2 Restoring Vision Sensor Data

To restore Vision sensor data:

1. Insert the PresencePLUS installation CD into the CD-ROM drive, and launch the install program.
2. Click on **PresencePLUS Update Firmware**.



The image shows a software interface for Banner PresencePLUS Vision Sensors. At the top center is the Banner logo and the text "PresencePLUS Vision Sensor". To the left is a photograph of a sensor unit with a camera lens. To the right is another photograph of a different sensor model. The interface is divided into two main sections: "User Information" and "Installs".

**Update Firmware 2008R1**  
(See "Firmware Update Version Information" for details)

**User Information :**

- ReadMe
- System Requirements
- Manuals
- Communication Setup Instructions
- Firmware Update Version Information

**Installs :**

- PresencePLUS PC Software
- PresencePLUS Update Firmware
- PresencePLUS Utility Programs
- Adobe Acrobat Reader
- Internet Explorer Version 6.0

**Exit**

<http://www.bannerengineering.com>

3. In the **PresencePLUS Firmware Updater**, click on the **Restore** tab.
4. From the list of sensors, select the one you want to restore to, and click **Connect**.
5. In the Restore Sensor section, click on the ellipses (...) button to select a backup file from which to restore the Vision sensor data.



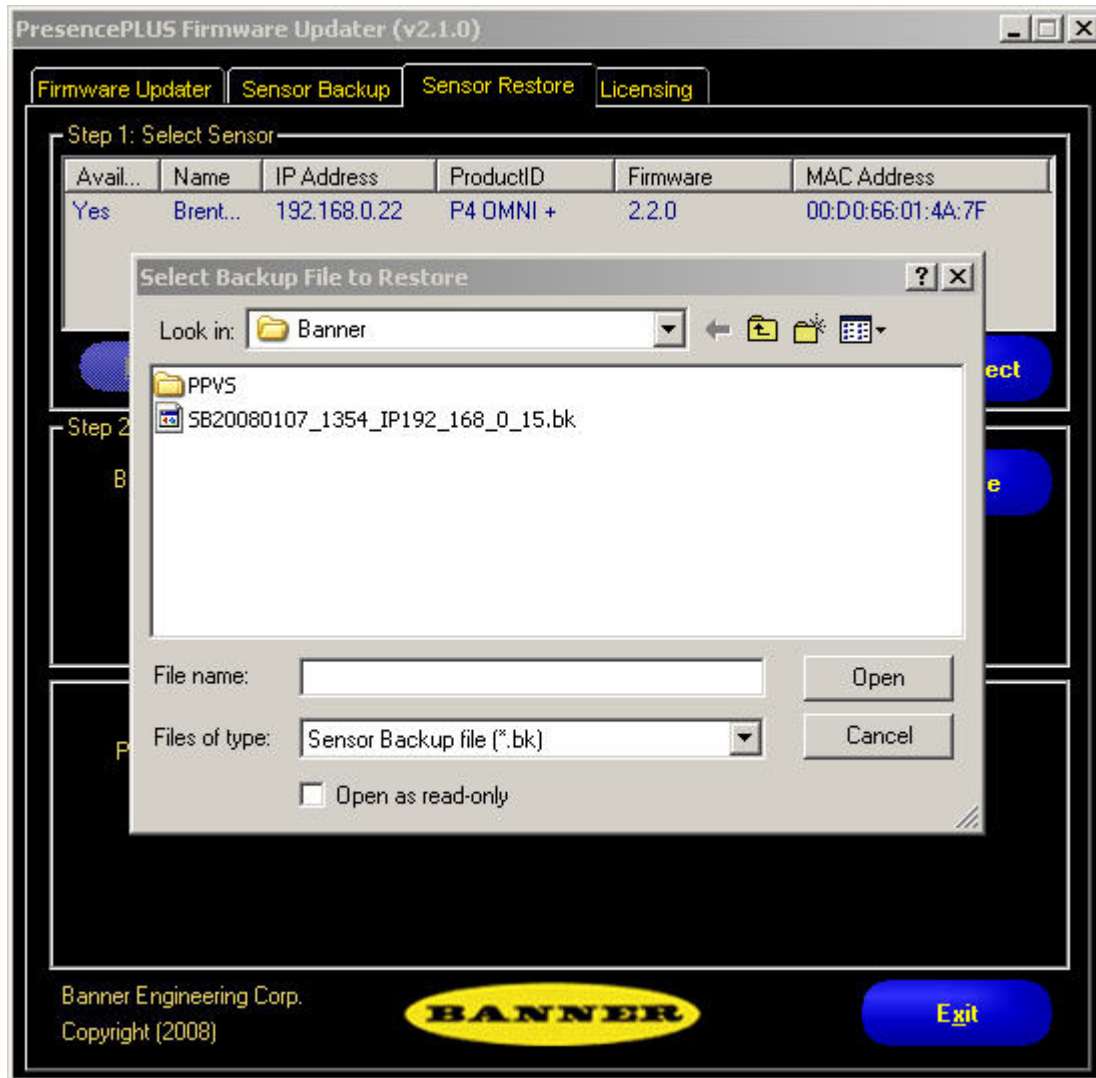

6. Optionally, click the **Read Note..** button to get more information about the restore.

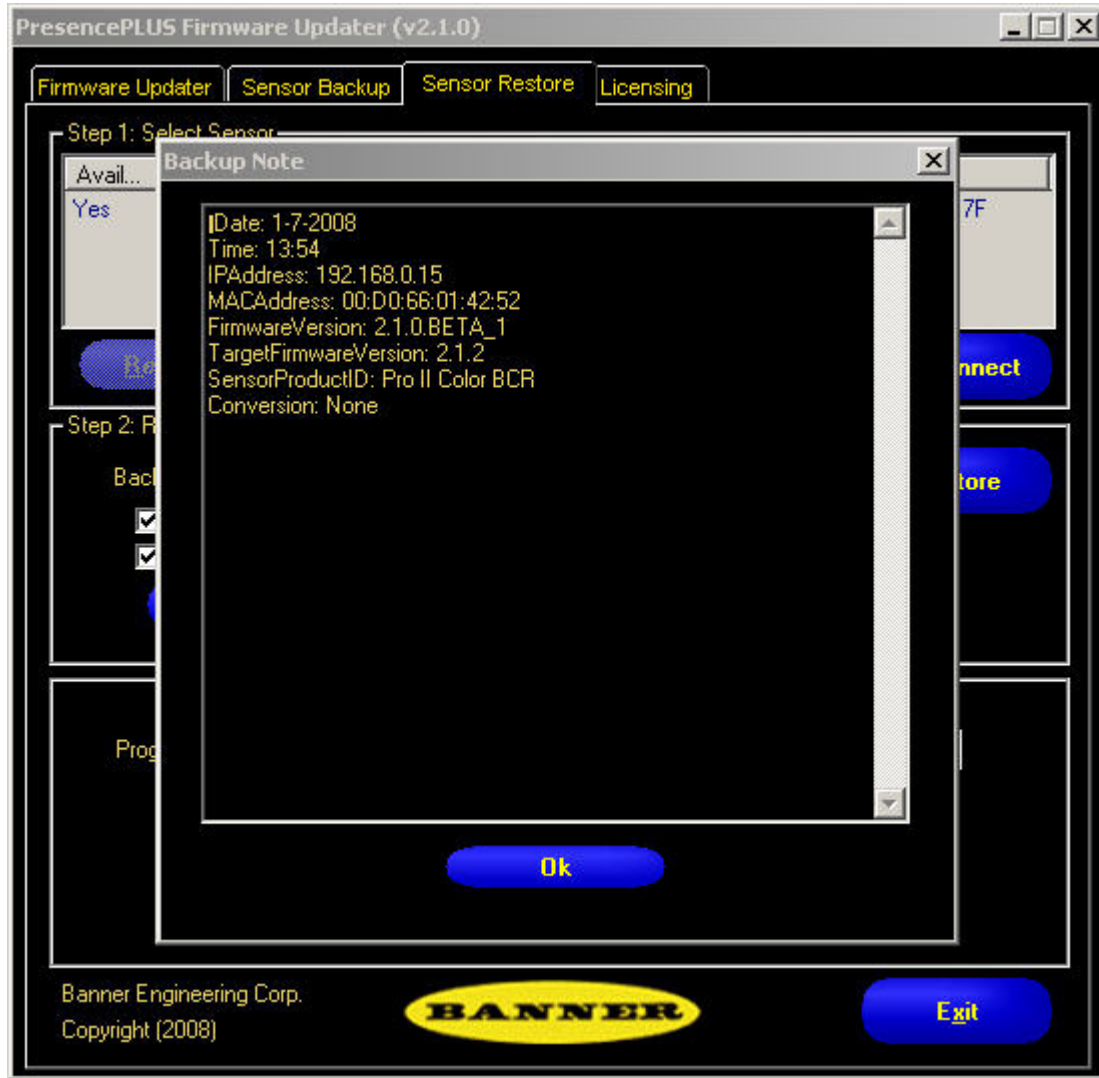

7. If desired, check the box next to **Restore Firmware** and/or **Optimized**.
8. Click the **Restore** button to restore Vision sensor data from the selected backup file.

# Dimensions and Specifications

## 15.1 Sensor Dimensions

### 15.1.1 Right-Angle Sensor Dimensions

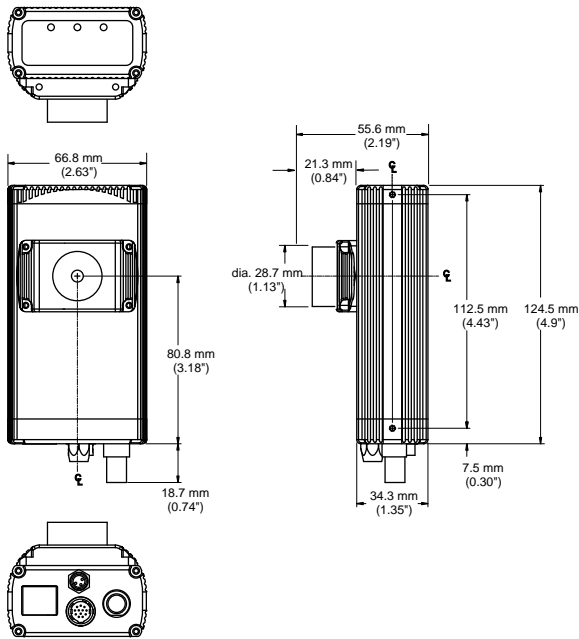

### 15.1.2 Right-Angle Sensor Mounting Bracket Dimensions

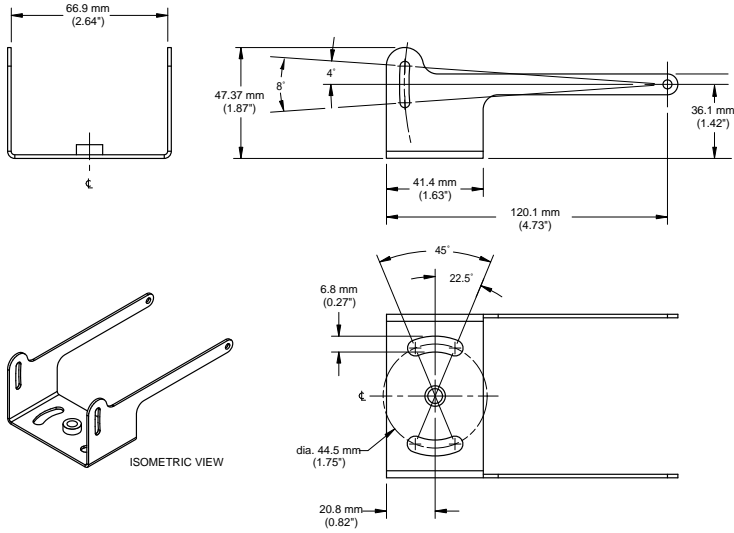

### 15.1.3 In-Line Sensor Dimensions

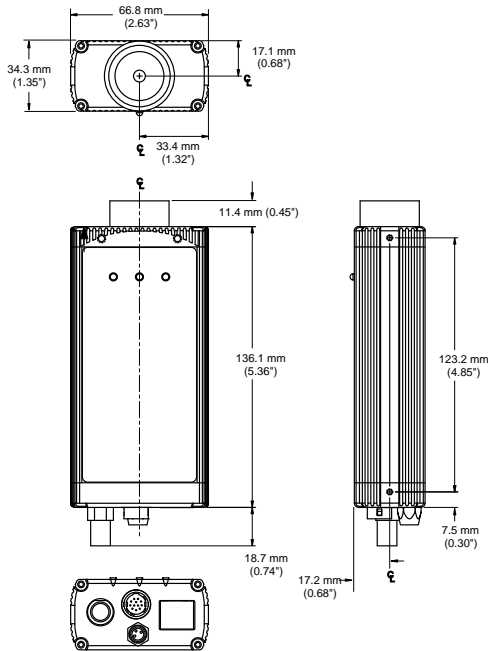

### 15.1.4 In-Line Sensor Mounting Bracket Dimensions

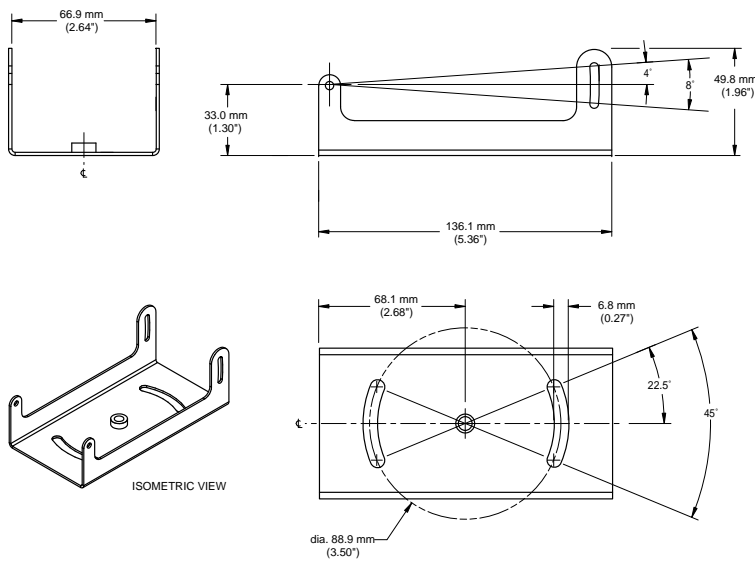

## 15.2 Sensor Specifications

Feature	Description
<b>Model Numbers</b>	<p><b>PresencePLUS P4 EDGE Right-Angle Sensor:</b> P4ER P4 EDGE In-Line Sensor: P4EI</p> <p><b>PresencePLUS P4 EDGE 1.3 Right-Angle Sensor:</b> P4E1.3R P4 EDGE 1.3 In-Line Sensor: P4E1.3I</p>
<b>Power</b>	<p><b>Voltage:</b> 10-30V dc (24V dc <math>\pm</math> 10% if a light source is powered by the Sensor)</p> <p><b>Current:</b> P4 EDGE: 500 mA maximum (exclusive of I/O load and lights) P4 EDGE 1.3: 550 mA maximum (exclusive of I/O load and lights)</p>
<b>Discrete I/O</b>	<p>1 Trigger IN</p> <p>1 Strobe OUT</p> <p>4 Programmable I/O</p> <p>1 Product Change</p> <p>1 Remote Teach</p>
<b>Input/Output Configuration</b>	NPN or PNP software selectable
<b>Output Rating</b>	<p>150 mA</p> <p><b>ON-State Saturation Voltage:</b> &lt;1V at 150 mA max. NpN; &gt;V <math>\pm</math> 2V</p>

Feature	Description
	<b>OFF-State Leakage Current:</b> <100 microamps NPN or PNP
<b>Communication</b>	1 RJ-45 Ethernet RS-232 flying leads
<b>Display Options</b>	PC or NTSC video; 9 m (30') max. cable length
<b>Memory</b>	<b>INS Storage Memory:</b> 8 MB <b>Number of INS Files:</b> 500 max.
<b>Acquisition</b>	<p><b>Frames Per Second:</b>      <b>P4 EDGE:</b> 500 max.    <b>P4 EDGE 1.3:</b> 26.8 max</p> <p><b>Image Size:</b>                    <b>P4 EDGE:</b> 128 X 100    <b>P4 EDGE 1.3:</b> 1280 X 1024</p> <p><b>Levels of Gray Scale:</b> 256</p>
<b>Exposure Time</b>	<b>P4 EDGE:</b> 0.1 to 20.47 ms <b>P4 EDGE 1.3:</b> 0.1 to 1670 ms
<b>Imager</b>	<b>P4 EDGE:</b> 2.6 X 2.0 mm, 3.3 mm diagonal (1/5 inch CMOS) <b>P4 EDGE 1.3:</b> 8.576 X 6.861 mm, 10.9829 mm diagonal (2/3 inch CMOS)
<b>Pixel Size</b>	<b>P4 EDGE:</b> 20 X 20 microns <b>P4 EDGE 1.3:</b> 6.7 X 6.7 micrometers
<b>Lens Mount</b>	C-mount
<b>Construction</b>	Black anodized aluminum sensor housing, glass lens. <b>Weight:</b> Approximately 0.29 kg (0.642 lb.)
<b>Environmental Rating</b>	IEC IP20; NEMA 1
<b>Operating Conditions</b>	<b>Stable Ambient Temperature:</b> 0° to + 50° C (+32° to + 122° F) <b>Stable Ambient Lighting:</b> No large, quick changes in light level; no direct or reflected sunlight <b>Relative Humidity:</b> 35-90%, non-condensing
<b>Certifications</b>	

### 15.3 Monitor Specifications - 9" CRT

Feature	Description
<b>Model Number</b>	PPM9
<b>Construction</b>	Metal case, glass screen <b>Dimensions:</b> 220 X 240 X 267 mm (8.66" X 9.45" X 10.51") <b>Weight:</b> 6 kg (13.2 lb.)
<b>Operating Conditions</b>	<b>Operating Temperature:</b> -10° to +55° C (+14° to 130° F) <b>Maximum Relative Humidity:</b> 95%, non-condensing
<b>Electrical</b>	<b>System:</b> NTSC compatible <b>Picture Tube:</b> 9" measured diagonally <b>Horizontal Resolution:</b> > 1000 TV lines (center), > 800 TV lines (corners) <b>Power Requirement:</b> 110-240V ac, 50/60 Hz <b>Power Consumption:</b> 0.5A
<b>Certifications</b>	Listed TV/Video Product 8K37, E133441  
<b>Controls/Connectors</b>	Horizontal Hold (rotary knob)      Vertical Hold (rotary knob) Brightness (rotary knob)              Contrast (rotary knob) Video IN-OUT (BNC)                      Impedance High/Low switch (75 Ohms)

### 15.4 Monitor Specifications - Flat Panel 8" LCD Color

Feature	Description
<b>Screen Size</b>	8" diagonal
<b>LCD Aspect Ratio</b>	4:3
<b>LCD Panel Type</b>	TFT Active Matrix
<b>Display Resolution</b>	800(H) x 600(V)
<b>Brightness (Central)</b>	350 Nit
<b>Viewing Angle</b>	Left and Right 80° Down 35°

Feature	Description
	Up 15°
<b>Supply Voltage</b>	12-24V dc Red Wire: +V Black Wire: -V
<b>Current Draw</b>	0.6 A @ 12V dc
<b>Connections</b>	Flying leads for power BNC for Video BNC adaptor provided
<b>Operating Temperature</b>	0° C to +50° C (+32° F to +122° F)
<b>Storage Temperature</b>	-20° C to +60° C (-4° F to +140° F)
<b>Video System</b>	NTCS/PAL Auto Switching
<b>Control</b>	Selectable on monitor or via remote control (included) On-screen control: Bright, contrast, color, tint
<b>Net Weight</b>	1.2 lb

## 15.5 Ethernet Communication Specifications

Use a crossover Ethernet cable for communicating directly with a PC. Use a straight Ethernet cable for communicating with a network device, such as an Ethernet hub or switch.

Feature	Description						
<b>Protocol</b>	TCP/IP						
<b>Data Transfer Rate</b>	10/100 Mbps						
<b>Max Cable Length</b>	120 m (393')						
<b>Recommended PC IP Address</b>	192.168.0.2						
<b>PC Subnet Mask</b>	255.255.255.0						
<b>Factory Default Sensor IP Address</b>	192.168.0.1						
<b>Connector</b>	RJ-45						
<b>Connector Pinout</b>	Use RJ-45 network crossover cable for direct connection to a PC. <table border="1" data-bbox="1230 1688 1479 1827"> <thead> <tr> <th>Pin</th> <th>Name</th> </tr> </thead> <tbody> <tr> <td>Pin 1</td> <td>TXD+</td> </tr> <tr> <td>Pin 2</td> <td>TXD-</td> </tr> </tbody> </table>	Pin	Name	Pin 1	TXD+	Pin 2	TXD-
Pin	Name						
Pin 1	TXD+						
Pin 2	TXD-						



Feature	Description		
		Pin 3	RXD+
		Pin 4	Not used
		Pin 5	Not used
		Pin 6	RXD-
		Pin 7	Not used
		Pin 8	Not used

### 15.6 Serial Port Communication Specifications

Feature	Description
Baud Rate	115K
Data Bits	Eight
Stop Bits	One
Parity	Odd
Flow Control	None
Connector	



---

## A

### **A/D converter**

Acronym for Analog-to-Digital Converter, an electronic device that converts data from analog form to digital representation.

### **Abs (Absolute Value)**

Abs (Absolute value) returns Abs(X1). The absolute value of an operand is its unsigned magnitude. For example, Abs(-1.5) and Abs(1.5) both return 1.5

### **acquisition**

The manner in which outside information is brought into an analysis system, as in an image acquisition. Generally involves A/D conversion.

### **adaptive threshold**

A control method in which a threshold is adjusted based on scene content.

### **algorithm**

A set of well-defined rules or procedures for solving a problem in a finite number of steps, or providing an output from a specific set of inputs. Usually implemented as a computer program.

### **ambient light**

Light that is present in the environment but not provided by the sensing system.

### **angle of incidence**

The angle between the axis of an impinging light beam and the axis perpendicular to the sample surface.

### **angle of view**

1. The angle formed between two lines drawn from the most widely separated points in the object plane to the center of the lens.
2. The angle between the axis of observation and perpendicular to the specimen surface.

### **aperture**

The size of a lens opening.

## **ASCII**

Acronym for American Standard Code for Information Interchange. An 8-bit coded character set used to represent alphanumeric, punctuation, and certain special control characters.

## B

### **backlighting**

A condition where the light reaching the image sensor does not reflect from the surface of the object, but comes from behind the objects or area of interest. Backlighting produces a silhouette of the work piece.

### **band-eliminator filter**

A filter that suppresses a given range of frequencies, transmitting only those above and below that band.

### **bandpass**

The specific range of frequencies or wavelengths, passing through a device. Typically measured between points equal to 50% of maximum amplitude.

---

## barrel distortions

An image appearing to bulge outward on all sides, like a barrel. This is caused by a decrease in effective magnification, as points in the image move a way from the image center.

## beam splitter

A device for dividing a light beam into two or more separate beams.

## bimodal

Histogram distribution of values with two peaks.

## binary system

A vision system that creates a digitized image of an object in which each pixel can have one of only two values, such as light/dark, or zero/one.

## Blob

cronym for Binary Large Object. A connected region in a binary image.

## blooming

The "smearing" of regions of the image where the detected brightness is at an excessive level for the receiving element, due to electronic contamination from neighboring bright pixels.

## C

### c-mount

Threaded lens mount developed from 16 mm movie work. used extensively for closed-circuit television. The threads have a major diameter of 1" and a pitch of 32 threads per inch. The flange focal distance is 0.69".

## calibration

The relationship between the output of a measuring instrument and some fiducial mark, an accepted standard of

measurement, or other reference datum for the purpose of reporting future results relative to the reference.

## centroid

The X and Y pixel coordinates of the center of mass in a two dimensional Blob.

## collimated

A beam of light in which all optical rays are parallel.

## contrast

The range of difference between light and dark values in an image.

## correlation

A process whereby two image segments are compared to determine their similarity, or to find the position at which optimal similarity exists.

## D

### dark field

An illumination technique supplying the illumination at a shallow (grazing) angle to the surface of the work piece. Ordinarily only a negligible amount of light reflects into the Sensor. Specular reflections occur off any abrupt surface irregularities, and are detectable in the image.

### depth of field

The in-focus range of an imaging system. Measured from the distance behind an object to the distance in front of the object, with all objects appearing in focus.

### depth of focus

The range of lens-to-image plane distance having the image formed by the lens appearing in focus.

---

## deslant

In order for the OCV/OCR Vision tool to box correctly, there must be a minimum of a 1 pixel-wide column between characters. If the characters are slanted in such a way that they overlap in this 1 pixel-wide column, then the image may need to be manipulated, or deslanted, so that the image can box correctly.

## diffuse

The process of redirecting incident light over a range of scattered angles, while reflecting from or transmitting through a material.

## distortion

Undesired change in the shape of an image or waveform from the original object or signal.

## edge

A change in pixel values exceeding some threshold between two adjacent regions of relatively uniform values. Edges correspond to changes in brightness corresponding to a discontinuity in surface orientation, reflectance, or illumination.

## f/stop (or f/number)

Ratio of the focal length of a lens to the diameter of its opening. Increasing or decreasing an exposure by one f/stop doubles or halves the amount of light allowed through the lens.

## feature

Any characteristic descriptive of an image or a region in an image.

## feature extraction

The process of generating a set of descriptors or characteristic attributes from an image.

## fiducial mark

A mark defining a datum point or standard of positional reference used as a basis for calculation or measurement.

## field of view (FOV)

The area of object space imaged at the focal plane of a lens.

## fluorescent lamp

A lamp that produces light by exciting a phosphor with a plasma, with the phosphor re-emitting the energy as light.

## focal length

The distance from a lens' principal point to the corresponding focal point. Also referred to as the equivalent focal length and the effective focal length.

## front lighting

An arrangement in which the object is illuminated and viewed from the same side.

## G

### gradient magnitude

The rate-of-change of pixel intensities over a small local neighborhood.

### gray scale

Standardized variations of values from white, through shades of gray, to black in a digitized image with black assigned the value of zero and white the value of 255.

## H

### halogen

A gas, such as iodine, placed inside an incandescent lamp to gather the evaporated filament off the bulb and redeposit it back onto the filament.

---

## high pass filter

A processing operation that enhances high frequencies (and attenuates low frequencies).

## histogram

Frequency counts of the population of pixels of each intensity (gray level) or other characteristic populations in an image.

## I

### incandescent

Thermal generation of light, usually through radiant filaments in a bulb.

### incident light

The light falling directly on an object.

### inverse square law

The exponential relationship between increased distance and decreased light intensity.

### iris

An adjustable aperture built into a Sensor lens to permit control of the amount of light passing through the lens.

## L

### LED

Acronym for Light-Emitting Diode.

## M

### mask

A pattern used to eliminate portions of another pattern. Regions of an image at a constant value, usually white or black, form the mask.

## N

### noise

Irrelevant or meaningless data resulting from various causes unrelated to the source of data being measured or inspected; random undesirable video signals.

## O

### ocr

Acronym for Optical Character Recognition. Recognition of each character in a string by a vision system.

### ocv

Acronym for Optical Character Verification. Verify a string by a vision system.

## P

### parallax

The difference in appearance or position of an object when viewed from two different locations.

### photon

A particle of light. A quantum of electromagnetic energy moving at the speed of light.

---

## **pincushion distortion**

A visual effect where the sides of an image appear to bulge inward on all sides like a pincushion. Caused by an increase in effective magnification, as points in the image move away from the image center.

## **pixel**

Acronym for picture element.

## **polarization**

The restriction of the vibrations of light or magnetic field vectors to one plane.

## **polarized lighting**

The use of polarizing filters to remove specular reflections from a scene to be viewed. Typically, one polarizing filter is placed in front of the light source and a second filter is placed over the receiver with the two filters offset in their polarizing direction by 90 degrees.

## **preprocessing**

Enhancement, transformation, or filtering of images before processing.

## **R**

### **recognition**

A match between a description derived from an image and a description obtained from a stored model or feature set.

### **region of interest (ROI)**

The Region of Interest (ROI) is the area to be analyzed inside user-defined boundaries.

### **repeatability**

The degree to which repeated measurements of the same quantity vary about their mean.

## **resolution**

1. The smallest detectable change in position or size of an object.
2. The closest distance between two objects (points) in an image, identifiable as two separate objects rather than one object.

## **S**

### **shift register**

An electronic circuit consisting of a series of storage locations (registers). During each clock cycle, the information in each location moves (shifts) into the adjacent location.

### **signal-to-noise ratio**

The ratio of the maximum value of an output signal to the standard deviation amplitude of the noise on the signal.

### **strobe light**

A pulsed illumination source that generates short bursts of high-intensity light.

### **sub-pixel resolution**

Any technique resulting in a measurement with a resolution (interpolated position of change) of less than one pixel.

## **T**

### **template matching**

Comparing a template with an object in an image. Usually performed at the pixel level, as with a template correlation.

### **threshold**

The intensity (specific pixel value) below which a stimulus produces no effect or response. Often used to convert a gray scale or analog image into a binary image.

---

## **thresholding**

A scene segmentation process based on converting a gray scale image into a binary image by reassigning pixel gray levels to only two values. Regions of the binary image are separated, based on whether pixel values in the gray scale image were above or below a chosen intensity level.

## **throughput**

The total capability of equipment to process or transmit data during a specified time period.

## **tolerance**

The established range upon which to base the differentiation between good and bad products.

## **translation**

Movement left or right, up or down, but not rotated; a geometrical operation that shifts the position of an image from its original position.

## **Z**

## **zoom**

Electronically or optically enlarging or reducing the size of an image.



---

# Index

## A

absolute positioning 102  
absolute threshold 98, 106, 113

## C

character strings 64, 200  
command processing  
    EXEC PRODCHANGE 62, 198  
    EXEC RESET 62, 198  
    EXEC TRIGGER 62, 198  
    GET 63, 198  
    SET EXPOSURE 63, 198  
communication tool 52, 121, 187  
    Ethernet connection 52, 187  
    setup 187  
Communication tool error codes 61, 197  
coordinate tool 137

## E

edge profile graph 98, 99, 106, 107, 113, 114  
edge strength 99, 107, 114  
edge tool 104  
error codes  
    Communication tool 61, 197  
    Reset command 62, 197  
    Trigger and Product Change 61, 197  
Ethernet connection 52, 187  
EXEC PRODCHANGE 62, 198  
EXEC RESET 62, 198  
EXEC TRIGGER 62, 198

## F

filters 100, 108, 115, 118  
Frame Tag Numbers 62, 197

## G

GET 63, 198

## I

input tab  
    locate tool 96  
inspection storage capacity 41

## L

linear tools  
    locate tool 96  
locate tool 96, 100, 101, 108, 109, 115, 116, 118, 119  
    filters 100, 101, 108, 109, 115, 116, 118, 119  
        min width 101, 109, 116, 119  
        ROI width 101, 108, 116, 119  
        sample rate 101, 109, 116, 119  
        smoothing 101, 108, 116, 119  
    input tab 96  
location tool  
    rotation enable 101

## M

math tool 140  
measure tool 145  
monitor tab  
    product select 211  
    ready 211  
    system error 211

## P

polarity 98, 99, 106, 107, 113, 114  
product select 211

## R

RCC log 63, 198  
RCC return values 61, 196  
ready 211  
relative threshold 98, 105, 113  
remote teach 169, 204  
Reset command error codes 62, 197  
ROI width 101, 108, 116, 119  
rotation enable 101  
run screen 207  
    monitor tab 207

## S

sample rate 101, 109, 116, 119  
sensor select tab 46  
SET GAIN 63, 198  
smoothing 101, 108, 116, 119  
storage capacity  
    inspections 41  
system error 211  
system setup  
    sensor select tab 46

## T

teach 201

teach screen 202

test tool 166

threshold 98, 105, 113

threshold type

absolute 98, 106, 113

edge strength 99, 107, 114

relative 98, 105, 113

tools

communication 121

coordinate 137

edge 104

locate tool 96

math 140

measure 145

test 166

Trigger and Product Change error codes 61, 197