

LR400 & PT400 *Opposed Mode Remote Sensor Pair*



The LR400 emitter and PT400 receiver are compact, totally-encapsulated opposed mode remote sensors whose threaded barrel design and excellent operating characteristics make them ideal for use on small conveyors and similar applications. Mounting and alignment are extremely simple, due to these sensors' wide field of view. The LR400 and PT400 mount through 3/8" (9.5mm) clearance holes, and are secured by two steel jam nuts (included).

The minimum object size needed to break the beam of the sensor beam is 1/8-inch. Optional lenses provide extended sensing range and/or higher excess gain. Identical optical performance (for unlensed sensors) is available in different housing styles in models LR/PT200, 250, and 300 (see Banner catalog). LR/PT400 series sensors may be adapted for use with fiberoptics via the accessory FOF-400 fiber adaptor.

These sensors may be used with Banner MICRO-AMP® MA3-4 and MA3-4P modulated amplifiers, MAXI-AMP™ CM Series modulated amplifiers, and MB Series amplifiers. The hookup information below applies to all LR/PT400 series sensors, including: LR400HF, HFSB, SS, V, VG, VH, and PT400F, SB, and SS.

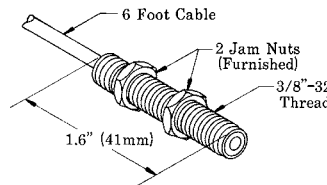

EXCESS GAIN

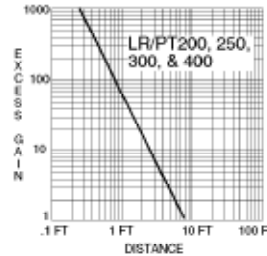

BEAM PATTERN

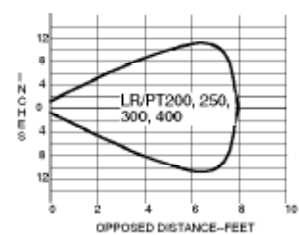

Specifications, LR400 and PT400

RANGE: up to 8 feet in opposed mode (see excess gain curve); up to 110' possible with optional L16 lenses.

EFFECTIVE BEAM: 0.14 inch (3.6 mm) diameter

RESPONSE SPEED: a function of the amplifier (see below)

OPERATING TEMPERATURE: -40 to +100° C (-40 to +212° F)

EMITTER CHARACTERISTICS (LR400): infrared LED, 880nm

CONSTRUCTION: totally encapsulated, hermetically sealed lenses. Anodized aluminum housings with two plated steel jam nuts (supplied). NEMA 1, 3, 4, 12, and 13.

CABLE: sensors are supplied with 6' of PVC-covered cable. 30' cables are available by special order.

Wiring rules:

- 1) Avoid running remote sensor cables in wireways together with power-carrying conductors.
- 2) Avoid running remote sensor cables through areas of known extreme electrical interference (electrical "noise").
- 3) Always use shielded cables and only connect the shield ("drain") wire at the amplifier.
- 4) When splicing, never combine emitter and receiver wires into a common cable. (The result will be electrical "crosstalk" within the cable, which causes a "lock-on" condition of the amplifier.)

Hookup to MB Series Amplifiers

Banner remote sensors will connect to any MB Series amplifier. The model MRB chassis (shown) has octal sockets for the amplifier and a BR-2 relay (supplied) and provides power for the sensors and amplifier. Up to four sensor pairs may be connected to one amplifier for light-operated OR or dark operated AND operation. In multiple-sensor hookups, receivers are wired in parallel and emitters are connected in series (see example for CM Series modules, next page).

Several MB Series amplifiers are available. Each provides a different output logic function. Chassis models with additional octal sockets are also available. Other types of output devices, including solid state relays, may be ordered (see Banner catalog).

Specifications, MB Series Amplifiers

POWER SUPPLY REQUIREMENT: 12-18V dc at less than 100mA, exclusive of load.

OUTPUT CONFIGURATION: open collector NPN transistor; maximum on-state current 250mA, maximum off-state leakage current 100 microamps.

RESPONSE SPEED: 1 millisecond ON and OFF.

MAXIMUM SENSOR LEAD LENGTH: 100 feet (30m) maximum; use separate shielded cables for emitter and receiver.

OPERATING TEMPERATURE RANGE: 0 to +50°C (+32 to +122° F).

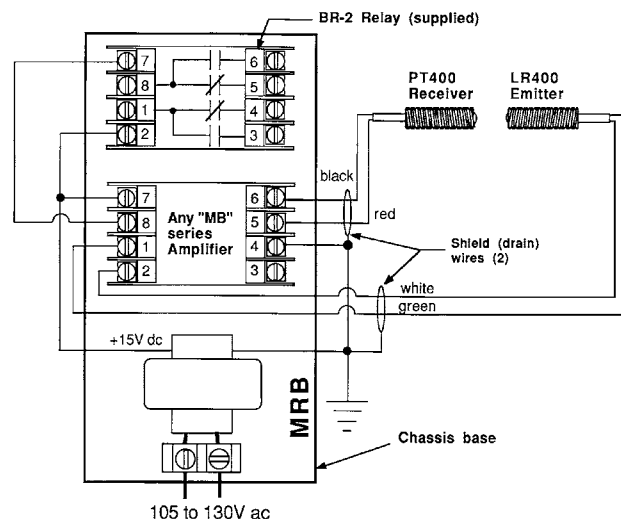

Hookup to MAXI-AMP™ CM Series Modules

CM Series modules combine power supply, modulated photoelectric amplifier, timing logic (CM5 models), and output relay in a single compact module. Only an 11-pin relay socket (Banner model RS-11) is needed to complete the system.

The CM Series contains models with or without programmable timing logic and with either electromechanical or solid-state relay outputs. See the Banner product catalog for further information.

Up to three sensor pairs may be connected to each amplifier. Light-operated OR logic (input to module occurs whenever at least one receiver

sees "light") or dark-operated AND logic (input to module occurs when all receivers simultaneously see "dark") is possible.

NOTE: to power the MAXI-AMP from a DC power supply, connect +12 to 18V dc at $\geq 70\text{mA}$ to terminal #3 and DC common to terminal #1. Make no connections to terminal #7 or #8.

To a Single Sensor Pair

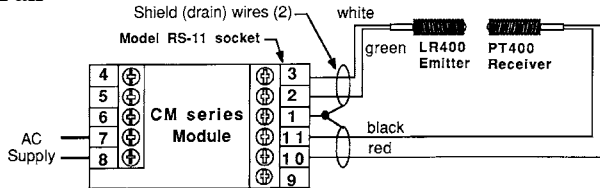

To Multiple Sensor Pairs

When wiring two sensors to one MAXI-AMP, multiply excess gain data (from excess gain curve) for each sensor by 1/2; when wiring three sensors to one MAXI-AMP, multiply excess gain by 1/3.

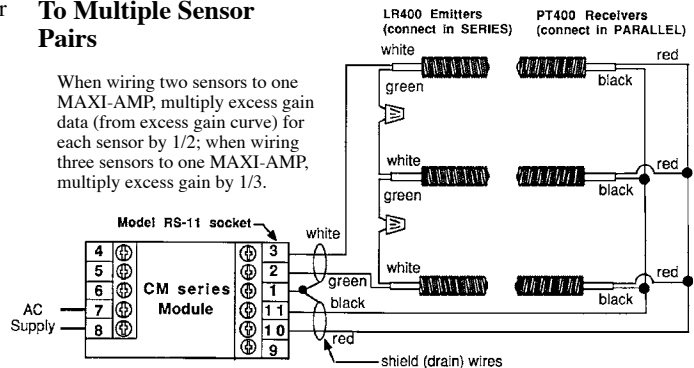

Specifications, MAXI-AMP CM Series Modules

RESPONSE SPEED: programmable for 10, 2, or 0.3 milliseconds (10 millisecond setting enhances noise rejection).

MAXIMUM SENSOR LEAD LENGTH: 50' (15m) maximum.

To avoid "cable crosstalk", use *separate* shielded cable for emitter and receiver, or order sensors with extended cable length.

OPERATING TEMPERATURE RANGE: 0 to +50 degrees C (+32 to +122 degrees F).

Hookup to MICRO-AMP® Modules

MICRO-AMP amplifier module models MA3-4 and MA3-4P may be used with this sensor pair. Model MA3-4 has complementary *current sinking* outputs. Model MA3-4P has complementary *current sourcing* outputs.

Model MA3-4 (but *not* model MA3-4P) may be powered by the model MPS-15 power supply, as shown in the hookup diagram (right). The MPS-15 includes a socket for the MA3-4 and has a built-in SPDT output relay (switchable by the MA3-4 module).

MICRO-AMP modules may also be mounted in a model RS8 wiring socket and powered from a "remote" power supply. PVC mounting track is available in 6" and 12" lengths to accommodate multiple MICRO-AMP system components.

NOTE: only one pair of LR/PT400s may be connected to each amplifier.

Specifications, MICRO-AMP MA3-4 & MA3-4P

POWER SUPPLY REQUIREMENT: 10-30V dc at less than 20mA; 10% maximum ripple (obtainable from MPS-15 power supply--see above).

OUTPUT CONFIGURATION: model MA3-4 has two open-collector NPN (current sinking) transistor solid state switches, one normally open, one normally closed. 150mA max. each output. Model MA3-4P has two PNP (sourcing) outputs, 150mA max. each.

RESPONSE SPEED: 1 millisecond ON and OFF.

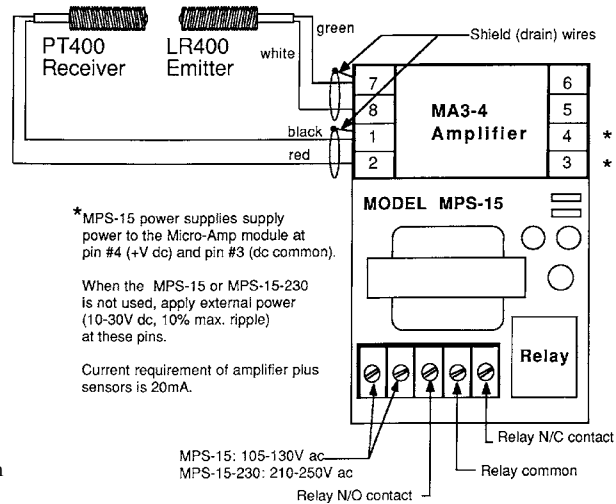

* MPS-15 power supplies supply power to the Micro-Amp module at pin #4 (+V dc) and pin #3 (dc common).

When the MPS-15 or MPS-15-230 is not used, apply external power (10-30V dc, 10% max. ripple) at these pins.

Current requirement of amplifier plus sensors is 20mA.

MPS-15: 105-130V ac
MPS-15-230: 210-250V ac

MAXIMUM SENSOR LEAD LENGTH: 30' (9m).

OPERATING TEMPERATURE RANGE:

-40 to +70 degrees C (-40 to +158 degrees F).



WARNING These photoelectric presence sensors and amplifiers do NOT include the self-checking redundant circuitry necessary to allow their use in personnel safety applications. A sensor or amplifier failure or malfunction can result in *either* an energized or a de-energized sensor output condition.

Never use these products as sensing devices for personnel protection. Their use as safety devices may create an unsafe condition which could lead to serious injury or death.

Only MACHINE-GUARD and PERIMETER-GUARD Systems, and other systems so designated, are designed to meet OSHA and ANSI machine safety standards for point-of-operation guarding devices. No other Banner sensors or controls are designed to meet these standards, and they must NOT be used as sensing devices for personnel protection.

Banner Engineering Corp Limited Warranty

Banner Engineering Corp. warrants its products to be free from defects in material and workmanship for one year following the date of shipment. Banner Engineering Corp. will repair or replace, free of charge, any product of its manufacture which, at the time it is returned to the factory, is found to have been defective during the warranty period. This warranty does not cover damage or liability for misuse, abuse, or the improper application or installation of the Banner product.

THIS LIMITED WARRANTY IS EXCLUSIVE AND IN LIEU OF ALL OTHER WARRANTIES WHETHER EXPRESS OR IMPLIED (INCLUDING, WITHOUT LIMITATION, ANY WARRANTY OF MERCHANTABILITY OR FITNESS FOR A PARTICULAR PURPOSE), AND WHETHER ARISING UNDER COURSE OF PERFORMANCE, COURSE OF DEALING OR TRADE USAGE.

This Warranty is exclusive and limited to repair or, at the discretion of Banner Engineering Corp., replacement. **IN NO EVENT SHALL BANNER ENGINEERING CORP. BE LIABLE TO BUYER OR ANY OTHER PERSON OR ENTITY FOR ANY EXTRA COSTS, EXPENSES, LOSSES, LOSS OF PROFITS, OR ANY INCIDENTAL, CONSEQUENTIAL OR SPECIAL DAMAGES RESULTING FROM ANY PRODUCT DEFECT OR FROM THE USE OR INABILITY TO USE THE PRODUCT, WHETHER ARISING IN CONTRACT OR WARRANTY, STATUTE, TORT, STRICT LIABILITY, NEGLIGENCE, OR OTHERWISE.**

Banner Engineering Corp. reserves the right to change, modify or improve the design of the product without assuming any obligations or liabilities relating to any product previously manufactured by Banner Engineering Corp.

