

8 7 6 5 4 3 2 1

D

C

B

A

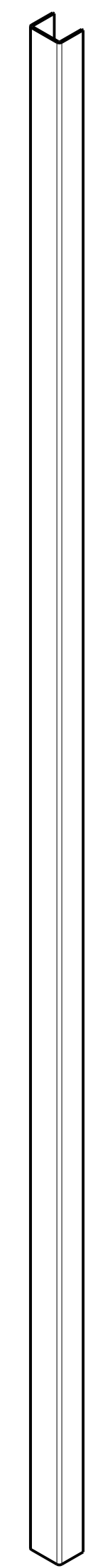
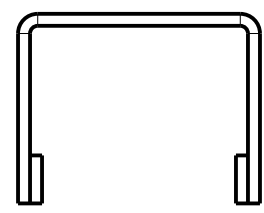
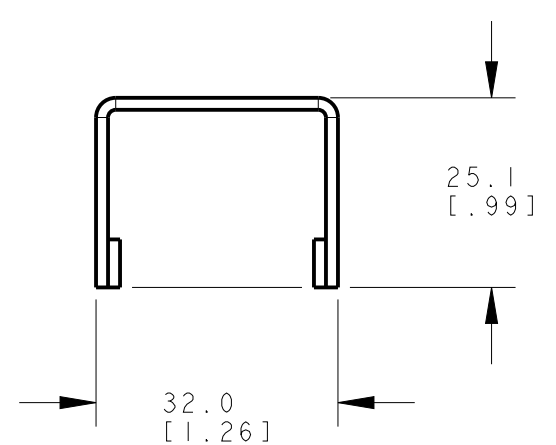
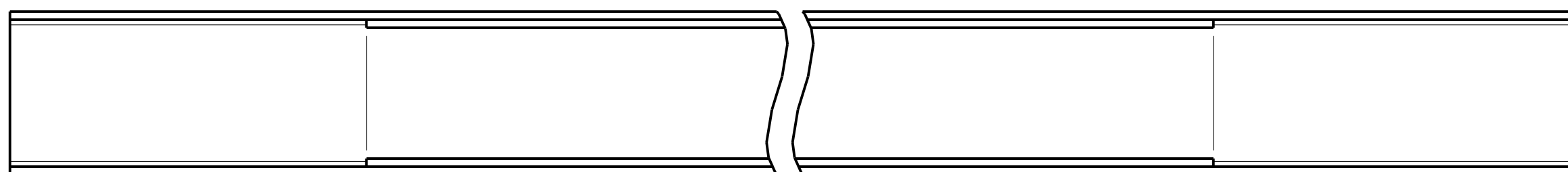
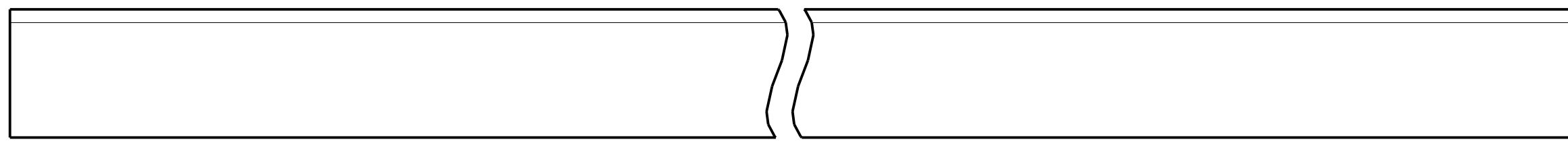
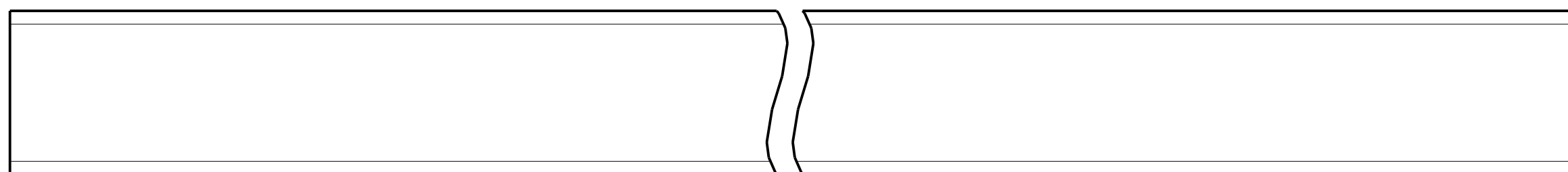

ISOMETRIC VIEW
SCALE 1:4

NOTES:
1. ALL DIMENSIONS ARE MILLIMETERS [INCHES] UNLESS OTHERWISE NOTED.
2. REFER TO "www.bannerengineering.com" FOR ADDITIONAL DATA AND SPECIFICATIONS.

This drawing is the property of BANNER ENGINEERING CORP. Any use or reproduction in any form, without prior written permission of Banner is prohibited.
© 2015 Banner Engineering Corp.



TITLE
LPSS-1390

THIRD ANGLE PROJECTION

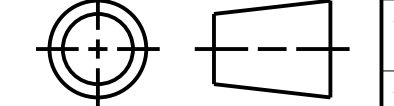

SIZE D DRAWING NO. **191541** REV. **A**

SCALE 1:1 SHEET 1 OF 1 CREO

8 7 6 5 4 3 2 1